

DIM.	TOL.
L≤10	±0.2
10<L≤30	±0.3
30<L≤50	±0.5
50<L≤100	±0.7
100<L≤250	±1.2
ABOVE 250	±1.5

REVISIONS			
REV	DESCRIPTION	DATE	BY

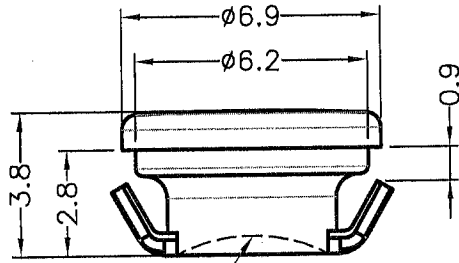

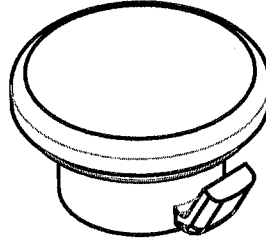
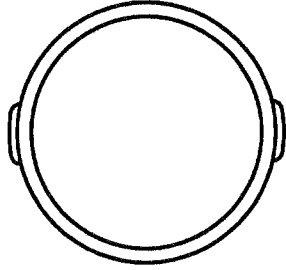
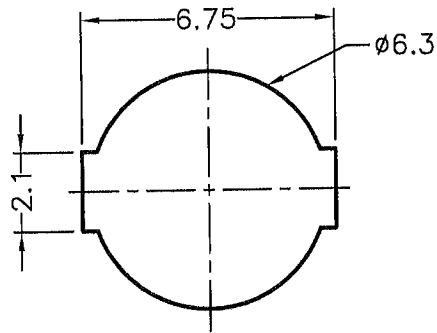
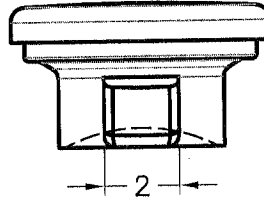

this area is polishing.



MOUNTING HOLE
CHASSIS THICKNESS 0.7mm

NOTE: All measurement does not include gate which raises under 0.3mm.

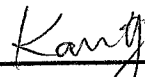
 康揚企業股份有限公司 KANG YANG HARDWARE ENTERPRISE CO., LTD. 康揚塑膠(東莞)有限公司 KANG YANG PLASTIC(DONG GUAN) CO., LTD. ISO 9001 ISO 14001 QC 080000 康哲電腦配件(吳江)有限公司 KANG CHE COMPUTER COMPONENTS(WUJIANG) CO., LTD.		TITLE	LIGHT PIPE	SPEC. DWG			
		MATERIAL	PC UL94V-2	DATE	2013.03.29		
		FINISH		DRAWN	Lyu		
		COLOR	CLEAR	CHECK			
PART NUMBER	LEM-161	DRAWING NUMBER	LEM-161	UNLESS OTHERWISE SPECIFIED TOLERANCE	SEE ABOVE	APPROVED	
SIZE	A4	SCALE	5:1	UNIT	mm	REV	A