

Common mode filter with ESD protection for high speed serial interface

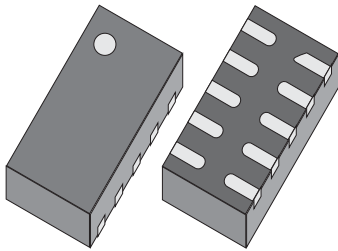

QFN-10L 2.6 x 1.35 x 0.5

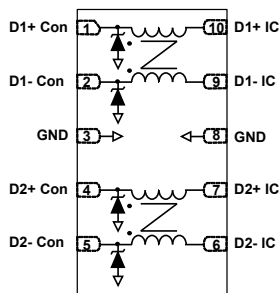

Product status link

[ECMF04-4HSWM10](#)

Product summary

Order code	ECMF04-4HSWM10
-------------------	--------------------------------

Features

- Very large differential bandwidth to comply with HDMI Full HD, MIPI, USB2.0, USB3.2 Gen 1, Display Port and other high speed serial interfaces
- High common mode attenuation on WLAN frequencies:
 - 28 dB at 2.4 GHz and -16 dB at 5.0 GHz
- Very good attenuation at LTE, GSM and GPS frequencies
- Large bandwidth: 4.2 GHz
- Low PCB space consumption
- Thin package for compact applications: 0.55 mm max.
- High reduction of parasitic elements through integration
- RoHS package

Exceed the following standards

- IEC 61000-4-2, level 4:
 - ±15 kV (air discharge)
 - ±8 kV (contact discharge)

Applications

- Mobile phones
- Notebook, laptop
- Portable devices
- PND

Description

The ECMF04-4HSWM10 is a highly integrated common mode filter designed to suppress EMI/RFI common mode noise on high speed differential serial buses like HDMI Full HD, MIPI, Display Port and other high speed serial interfaces.

The device has a very large differential bandwidth to comply with these standards and can protect and filter two differential lanes.

1 Characteristics

Table 1. Absolute maximum ratings ($T_{amb} = 25\text{ }^{\circ}\text{C}$)

Symbol	Parameter	Value	Unit	
V_{PP}	Peak pulse voltage	IEC 61000-4-2: Contact discharge	8	kV
		Air discharge	16	
I_{RMS}	Maximum RMS current	100	mA	
T_{op}	Operating ambient temperature range	-55 to +125	°C	
T_j	Maximum junction temperature	125		
T_{stg}	Storage temperature range	-55 to +150		

Figure 1. Electrical characteristics (definitions)

- V_{RM} Maximum stand-off voltage
- V_{CL} Clamping voltage at peak pulse current I_{PP}
- I_{RM} Leakage current at V_{RM}
- I_{PP} Peak pulse current
- V_{BR} Breakdown voltage
- R_{DC} DC serial resistance
- f_C Differential cut off frequency

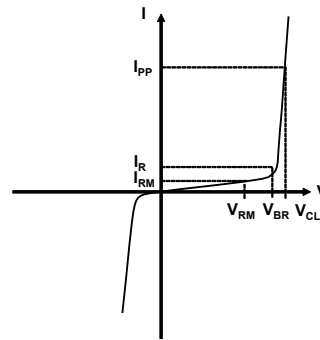

Table 2. Electrical characteristics ($T_{amb} = 25\text{ }^{\circ}\text{C}$)

Symbol	Test conditions	Min.	Typ.	Max.	Unit
V_{BR}	$I_R = 1\text{ mA}$	4.5	5.5		V
I_{RM}	$V_{RM} = 3\text{ V per line}$			100	nA
R_{DC}	DC serial resistance		5		Ω
f_C	-3 dB differential mode cut-off frequency		4.2		GHz

Table 3. Pin description

Pin number	Description	Pin number	Description
1	D1+ to connector	6	D2- to IC
2	D1- to connector	7	D2+ to IC
3	GND	8	GND
4	D2+ to connector	9	D1- to IC
5	D2- to connector	10	D1+ to IC

1.1 Characteristics (curves)

Figure 2. Differential attenuation versus frequency
($Z_{0_DIFF} = 100 \Omega$)

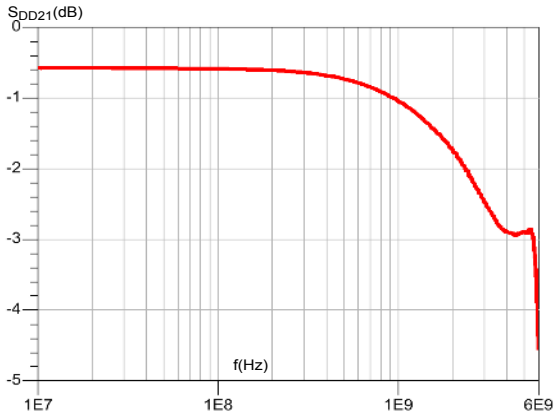

Figure 3. Common mode attenuation versus frequency
($Z_{0_COM} = 50 \Omega$)

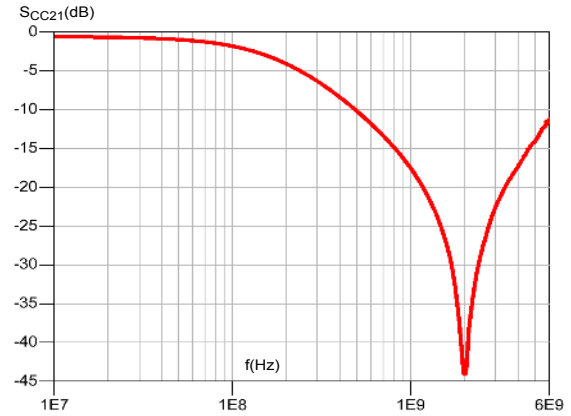

Figure 4. ESD response to IEC61000-4-2 (+8 kV contact discharge)

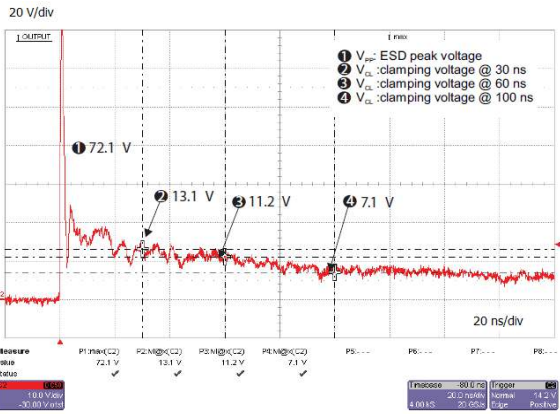

Figure 5. ESD response to IEC61000-4-2 (-8 kV contact discharge)

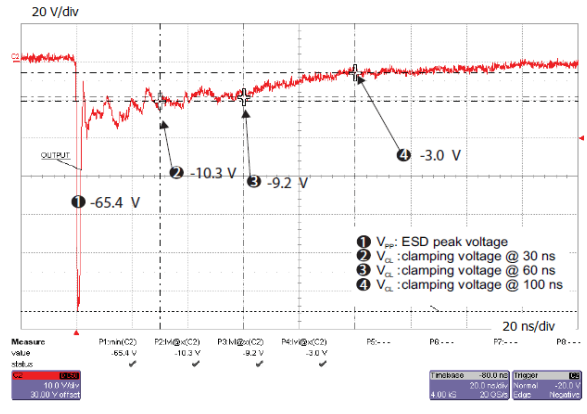

Figure 6. HDMI2.0 - 5.94 Gbps eye diagram without device
(with worst cable and equalizer)

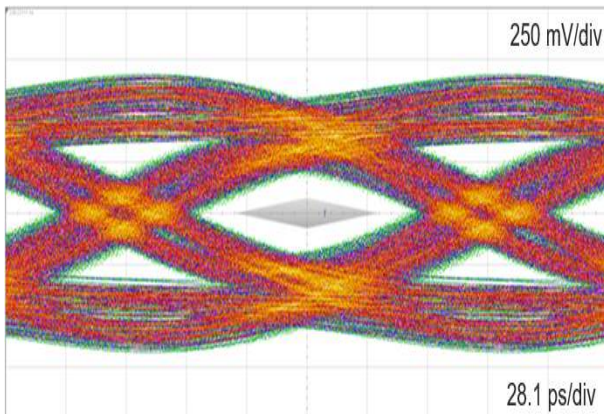

Figure 7. HDMI2.0 - 5.94 Gbps eye diagram with device
(with worst cable and equalizer)

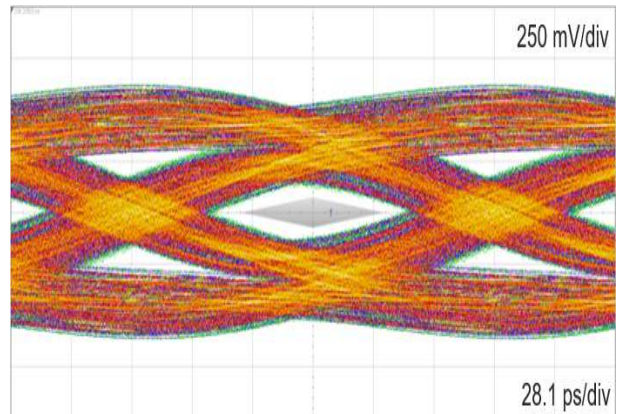

Figure 8. HDMI1.4 3.35 Gbps eye diagram without ECMF04-4HSWM10

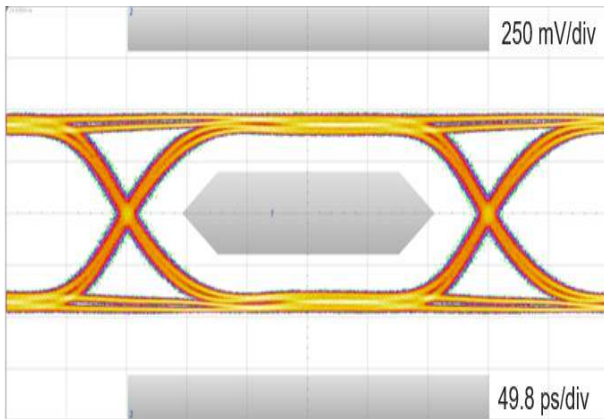

Figure 9. HDMI1.4 3.35 Gbps eye diagram with ECMF04-4HSWM10

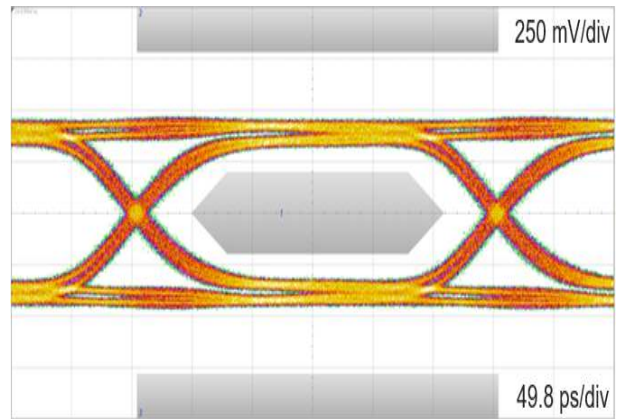

Figure 10. USB3.2 Gen 1 5.0 Gbps eye diagram without ECMF04-4HSWM10 (with worst cable and equalizer)

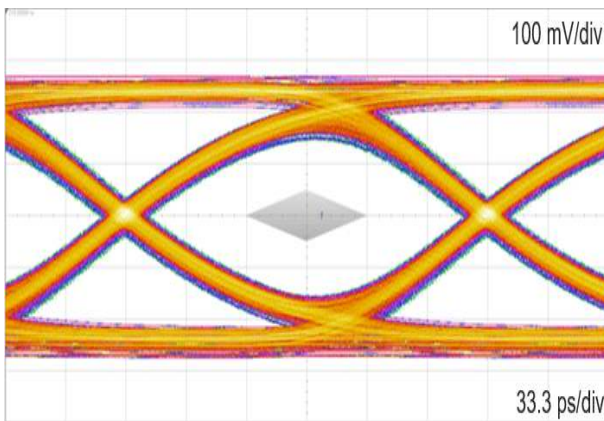

Figure 11. USB3.2 Gen 1 5.0 Gbps eye diagram with ECMF04-4HSWM10 (with worst cable and equalizer)

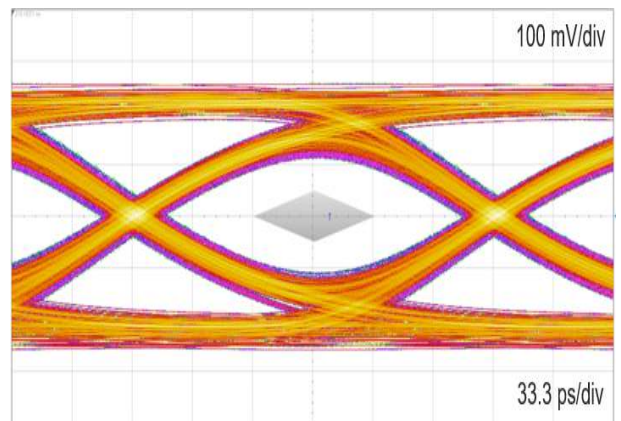

Figure 12. MIPI D-PHY 2.5 Gbps long reference channel eye diagram without ECMF04-4HSWM10

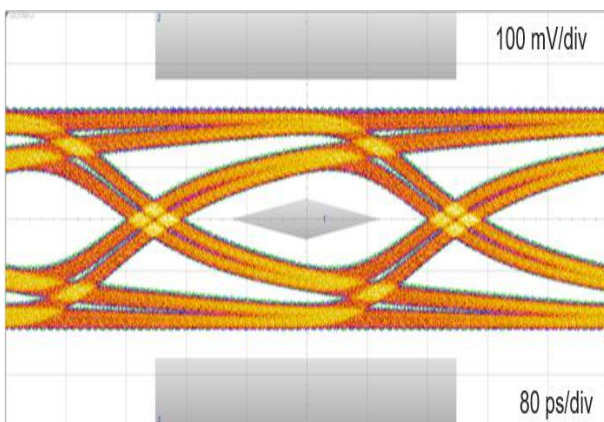

Figure 13. MIPI D-PHY 2.5 Gbps long reference channel eye diagram with ECMF04-4HSWM10

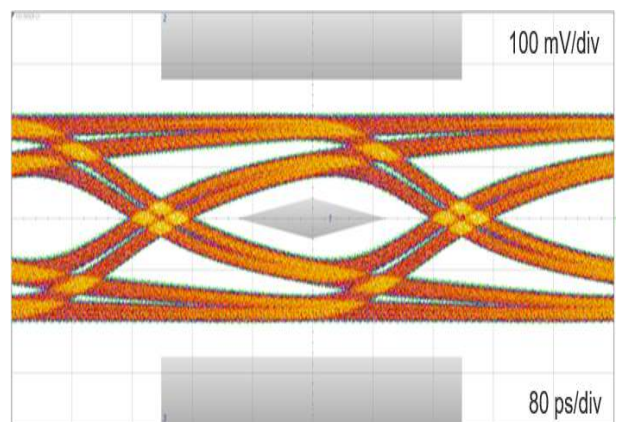

Figure 14. TDR

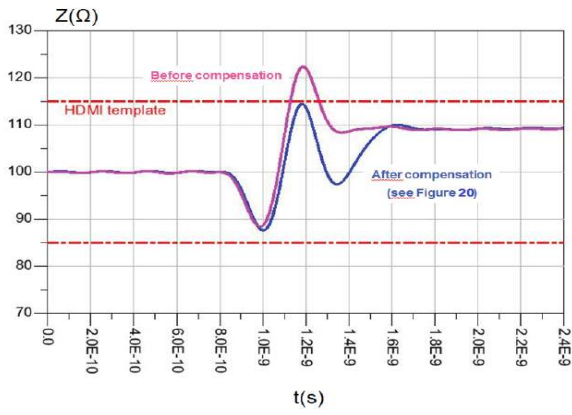
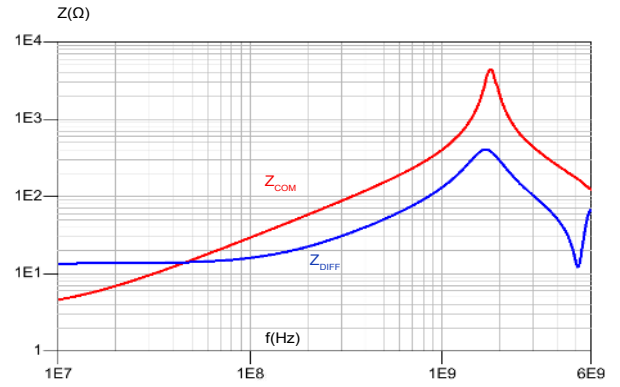
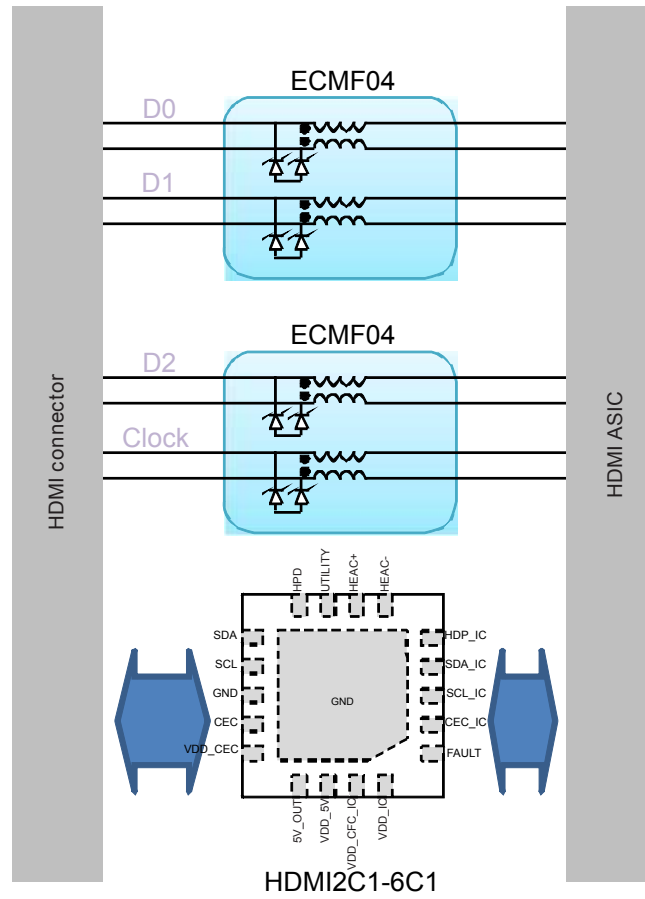

Figure 15. Differential and common mode impedance versus frequency



2 Application information

Figure 16. HDMI schematic



More application information available in following AN:

- [AN4356](#): "Antenna desense on handheld equipment"
- [AN4511](#): "Common mode filters"
- [AN4540](#): "MHL link filtering and protection"

3 Package information

In order to meet environmental requirements, ST offers these devices in different grades of **ECOPACK** packages, depending on their level of environmental compliance. ECOPACK specifications, grade definitions and product status are available at: www.st.com. ECOPACK is an ST trademark.

3.1 QFN-10L package information

Figure 17. QFN10L package outline

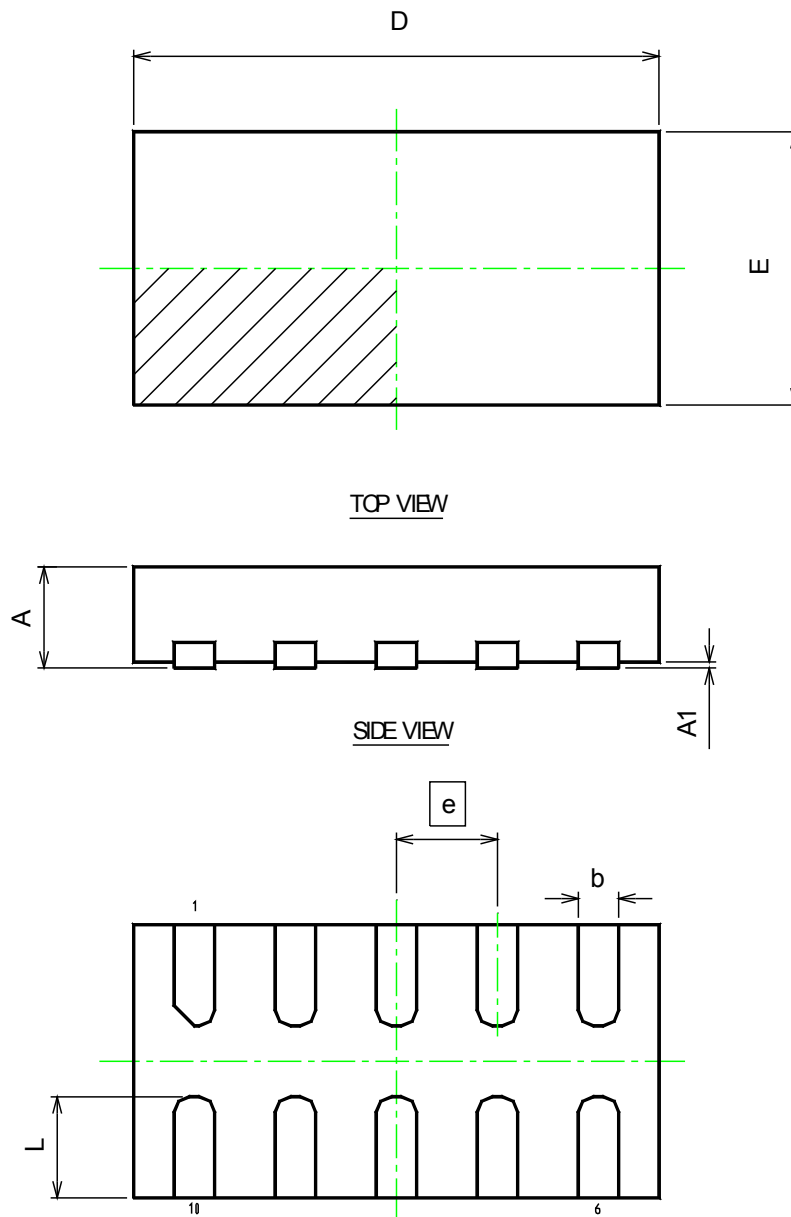
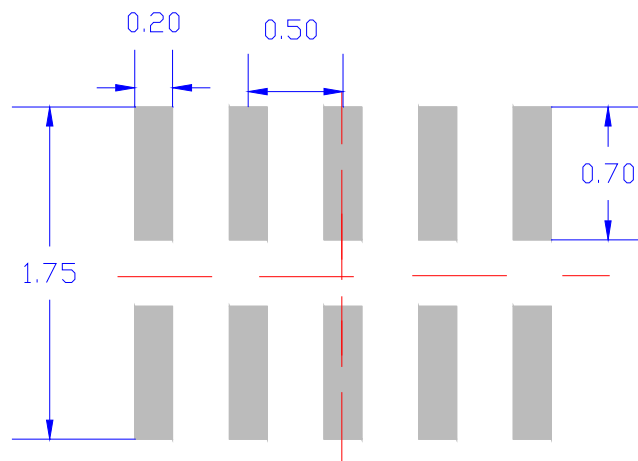

Table 4. QFN10L package mechanical data

Ref.	Dimensions		
	Millimeters		
	Min.	Typ.	Max.
A	0.45	0.50	0.55
A1	0.00	0.02	0.05
b	0.15	0.20	0.25
D	2.55	2.60	2.65
E	1.30	1.35	1.40
e		0.50	
L	0.40	0.50	0.60

Figure 18. Footprint recommendations (mm)



4 PCB assembly recommendation

Figure 19. Recommended PCB layout

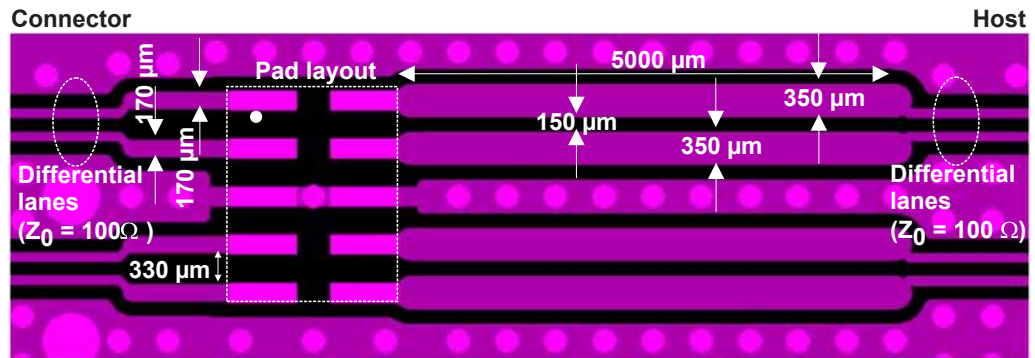
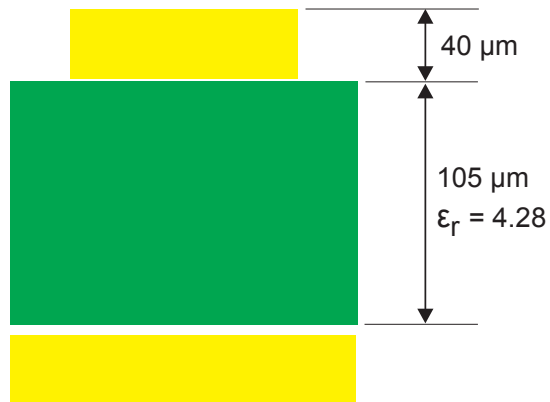

Figure 20. PCB stack dimensions



4.1 Solder paste

1. Halide-free flux qualification ROL0 according to ANSI/J-STD-004.
2. "No clean" solder paste is recommended.
3. Offers a high tack force to resist component movement during high speed.
4. Use solder paste with fine particles: powder particle size is 20-38 μm .

4.2 QFN-10L packing information

Figure 21. Marking

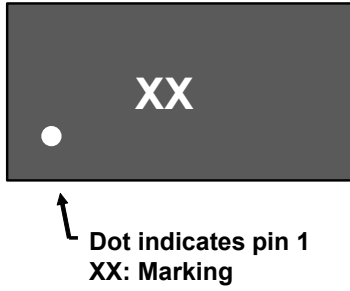

Figure 22. Package orientation in reel

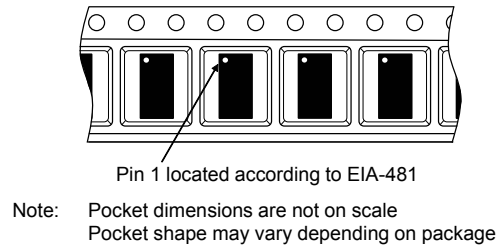

Figure 23. Tape and reel orientation

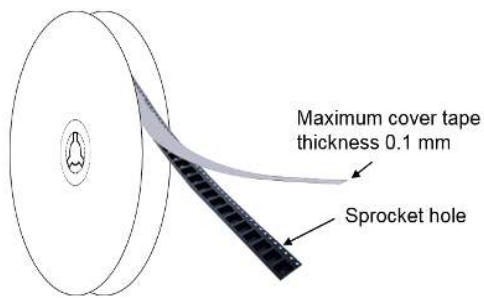

Figure 24. Reel dimensions (mm)

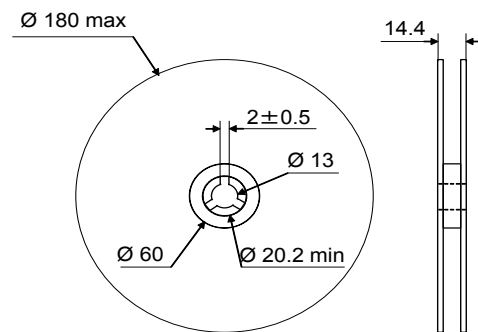

Figure 25. Inner box dimensions (mm)

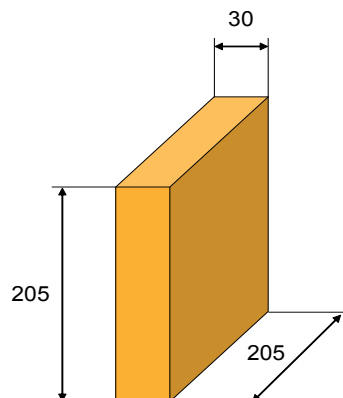
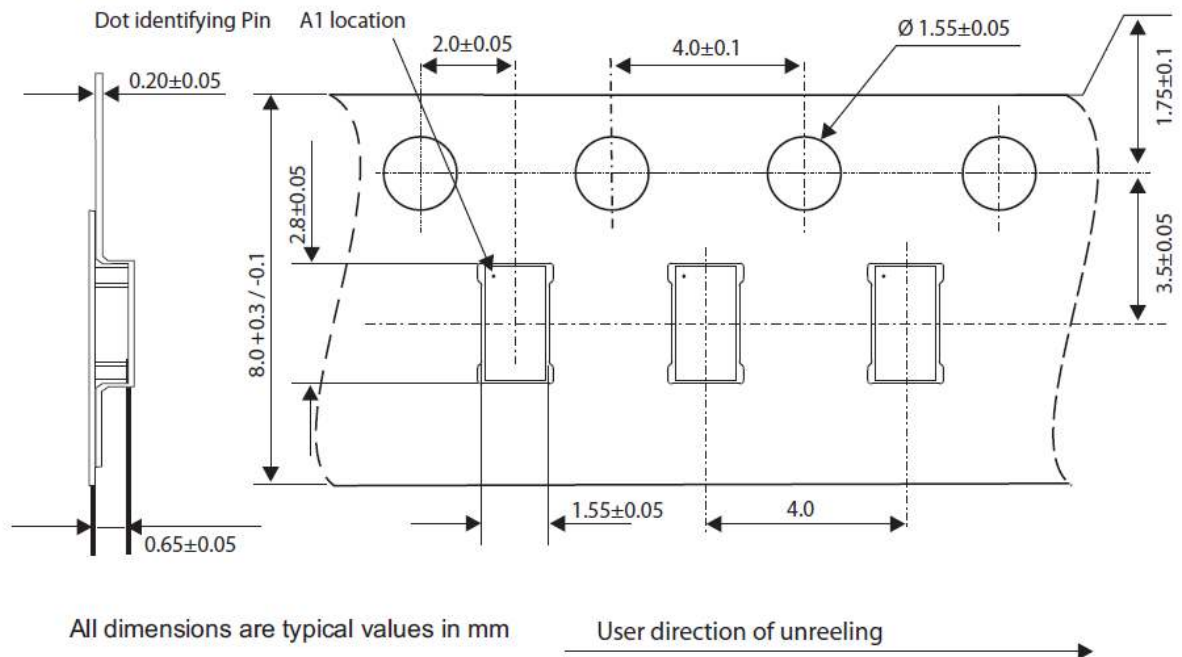
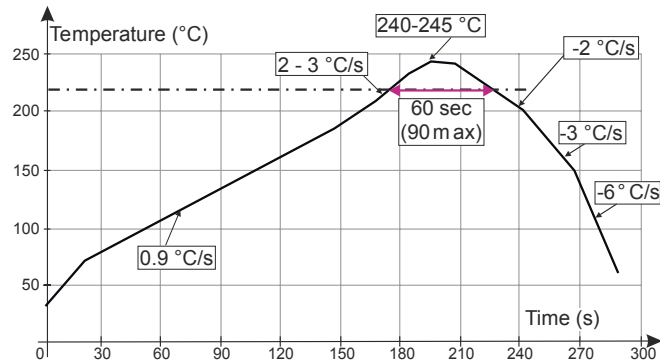

Figure 26. Tape and reel outline

4.3 Solder reflow

Figure 27. ST ECOPACK® recommended soldering reflow profile for PCB mounting

Note: Minimize air convection currents in the reflow oven to avoid component movement. Maximum soldering profile corresponds to the latest IPC/JEDEC J-STD-020.

5 Ordering information

Figure 28. Ordering information scheme

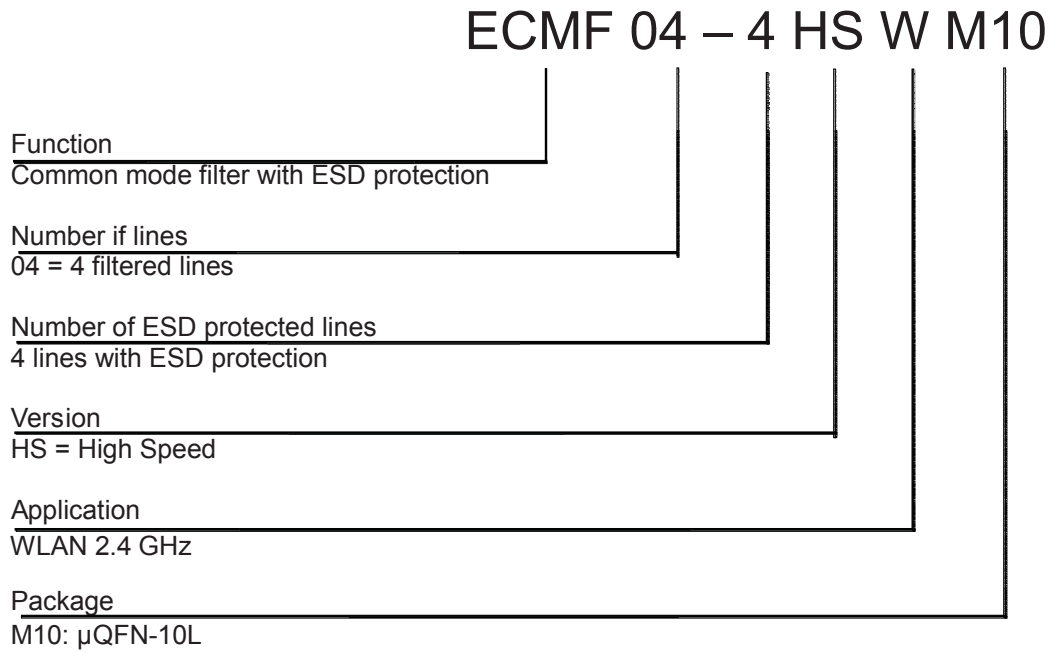

Order code	Marking	Package	Weight	Base qty.	Delivery mode
ECMF04-4HSWM10	KW ⁽¹⁾	μ QFN-10L	5 mg	3000	Tape and reel

1. The marking can be rotated by 90° to differentiate assembly location

Revision history

Table 5. Document revision history

Date	Version	Changes
10-Jun-2014	1	Initial release.
08-Jan-2018	2	Updated Table 1.
16-Mar-2021	3	Updated Figure 8 and Figure 9 . Added Figure 10 , Figure 11 and Figure 15 .

IMPORTANT NOTICE – PLEASE READ CAREFULLY

STMicroelectronics NV and its subsidiaries (“ST”) reserve the right to make changes, corrections, enhancements, modifications, and improvements to ST products and/or to this document at any time without notice. Purchasers should obtain the latest relevant information on ST products before placing orders. ST products are sold pursuant to ST’s terms and conditions of sale in place at the time of order acknowledgement.

Purchasers are solely responsible for the choice, selection, and use of ST products and ST assumes no liability for application assistance or the design of Purchasers’ products.

No license, express or implied, to any intellectual property right is granted by ST herein.

Resale of ST products with provisions different from the information set forth herein shall void any warranty granted by ST for such product.

ST and the ST logo are trademarks of ST. For additional information about ST trademarks, please refer to www.st.com/trademarks. All other product or service names are the property of their respective owners.

Information in this document supersedes and replaces information previously supplied in any prior versions of this document.

© 2021 STMicroelectronics – All rights reserved