



ARM Cortex™-M0 32-BIT MICROCONTROLLER

NuTiny-SDK-100 User Manual

For NuMicro™ NUC100 Series

The information described in this document is the exclusive intellectual property of Nuvoton Technology Corporation and shall not be reproduced without permission from Nuvoton.

Nuvoton is providing this document only for reference purposes of NuMicro™ microcontroller based system design. Nuvoton assumes no responsibility for errors or omissions.

All data and specifications are subject to change without notice.

For additional information or questions, please contact: Nuvoton Technology Corporation.

1	Overview.....	3
2	NuTiny-SDK-100 Introduction	3
2.1	NuTiny -SDK-100 Jumper Description	4
2.2	Pin Assignment for Extended Connector	5
2.3	NuTiny-SDK-100 PCB Placement.....	5
3	How to Start NuTiny -SDK-100 on the Keil μ Vision [®] IDE	6
3.1	Keil μ Vision [®] IDE Software Download & Install	6
3.2	Nuvoton Nu-Link Driver Download & Install	6
3.3	Hardware Setup	6
3.4	Smpl_NuTiny-NUC100 Example Program	7
4	How to Start NuTiny-SDK-100 on the IAR Embedded Workbench	8
4.1	IAR Embedded Workbench Software Download and Install	8
4.2	Nuvoton Nu-Link Driver Download and Install	8
4.3	Hardware Setup	8
4.4	Smpl_NuTiny-NUC100 Example Program	9
5	NuTiny-EVB-100 Schematic.....	10
6	To Download NuMicro [™] Family Related Files from Nuvoton Company	11
6.1	To Download NuMicro [™] Keil μ Vision [®] IDE driver.....	11
6.2	To Download NuMicro [™] IAR EWARM driver	12
6.3	To Download NuMicro [™] NUC100 series BSP Software Library	13
7	Revision History	14

1 Overview

NuTiny-SDK-100 is the specific development tool for NuMicro NUC100 series. Users can use NuTiny-SDK-100 to develop and verify the application program easily.

NuTiny-SDK-100 includes 2 portions. One is NuTiny-EVB-100 and the other is Nu-Link-Me. NuTiny-EVB-100 is the evaluation board and Nu-Link-Me is its Debug Adaptor. Thus, users do not need other additional ICE or debug equipment.

2 NuTiny-SDK-100 Introduction

NuTiny-SDK-100 uses the NUC100LE3AN as the target microcontroller. Figure 2-1 is NuTiny-SDK-100 for NUC100 series and the left portion is called NuTiny-EVB-100 and the right portion is Debug Adaptor called Nu-Link-Me.

NuTiny-EVB-100 is similar to other development board. Users can use it to develop and verify applications to emulate the real behavior. The on board chip covers NUC100 series features. The NuTiny-EVB-100 can be a real system controller to design user target system.

Nu-Link-Me is a Debug Adaptor. **The Nu-Link-Me Debug Adaptor connects your PC's USB port to your target system (via Serial Wired Debug Port) and allows you to program and debug embedded programs on the target hardware.** To use Nu-Link-Me Debug adaptor with IAR or Keil, please refer to “Nuvoton NuMicro™ IAR ICE driver user manual “or Nuvoton NuMicro™ Keil ICE driver user manual” in detail. These 2 documents will be stored in local hard disk when user installs each driver.

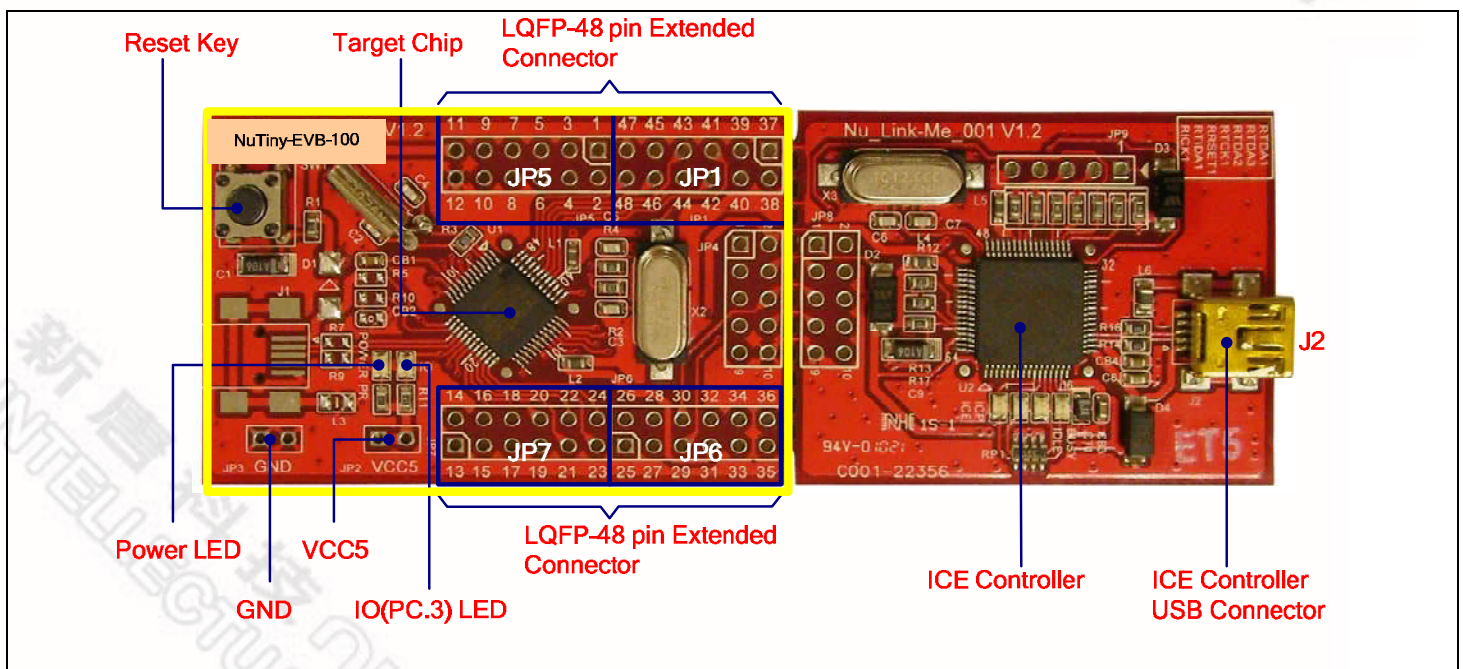

Figure 2-1 NuTiny-SDK-100 (Red Color PCB Board)

2.1 NuTiny -SDK-100 Jumper Description

2.1.1 Power Setting

- JP2: VCC5 Voltage connector in NuTiny-EVB-100
- J2: USB port in Nu-Link-Me

POWER model	J2 USB port	JP2 VCC5	MCU Voltage
Model 1	Connect to PC	DC 5V output	DC 5V
Model 2	X	DC 2.8-5.5V input	Voltage by VCC input

X: Not use.

2.1.2 Debug Connector

- JP4: Connector in target board(NuTiny-EVB-100) for connecting with Nuvoton ICE adaptor (Nu-Link-Me)
- JP8: Connector in ICE adaptor (Nu-Link-Me) for connecting with a target board (for example NuTiny-EVB-100)

2.1.3 USB Connector

- J1: Mini USB Connector in NuTiny-EVB-100 for application use
- J2: Mini USB Connector in Nu-Link-Me connected to a PC USB port

2.1.4 Extended Connector

- JP1, JP5, JP6 and JP7: Show all of chip pins in NuTiny-EVB-100

2.1.5 Reset Button

- SW1: Reset button in NuTiny-EVB-100

2.1.6 Power Connector

- JP2: VCC connector in NuTiny-EVB-100
- JP3: GND connector in NuTiny-EVB-100

2.2 Pin Assignment for Extended Connector

NuTiny-EVB-100 provides NUC100LE3AN on board and the extended connector for LQFP-48 pin. Table 2-1 is the pin assignment for NUC100LE3AN.

Pin No	Pin Name	Pin No	Pin Name
01	PB.12, CPO0. CLKO	25	PA.15, PWM3, I2SMCLK
02	X32O	26	PA.14, PWM2,
03	X32I	27	PA.13, PWM1
04	PA.11, I2C1SCL	28	PA.12, PWM0
05	PA.10, I2C1SDA	29	ICE_DAT
06	PA.9, I2C0SCL	30	ICE_CLK
07	PA.8, I2C0SDA	31	AVSS
08	PB.4, RX1	32	PA.0, ADC0
09	PB.5, TX1	33	PA.1, ADC1
10	LDO	34	PA.2, ADC2
11	VDD	35	PA.3, ADC3
12	VSS	36	PA.4, ADC4
13	PB.0, RX0	37	PA.5, ADC5
14	PB.1, TX0	38	PA.6, ADC6
15	PB.2, RTS0	39	PA.7, ADC7
16	PB.3, CTS0	40	AVDD
17	PC.3, MOSI00, I2SDO	41	PC.7, CPN0
18	PC.2, MISO00, I2SDI	42	PC.6, CPP0
19	PC.1, SPICLK0, I2SBCLK	43	PB.15, /INT1
20	PC.0, /SPISS00, I2SLRCLK	44	XT1_OUT
21	PE.5, PWM5	45	XT1_IN
22	PB.11, TM3, PWM4	46	/RESET
23	PB.10, TM2, /SPISS01	47	PVSS
24	PB.9/ TM1	48	PB.8, STADC, TM0

Table 2-1 Pin Assignment for NUC100 Series

2.3 NuTiny-SDK-100 PCB Placement

Users can refer Figure 2-2 for the NuTiny -SDK-100 PCB placement.

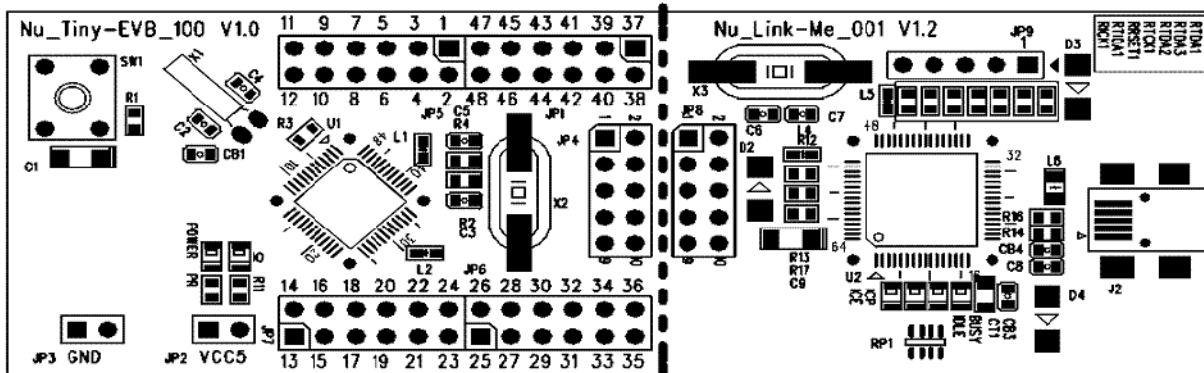

Figure 2-2 NuTiny-SDK-100 PCB Placement

3 How to Start NuTiny -SDK-100 on the Keil μ Vision[®] IDE

3.1 Keil μ Vision[®] IDE Software Download & Install

Please visit the Keil company website (<http://www.keil.com>) to download the Keil μ Vision[®] IDE and install the RVMDK.

3.2 Nuvoton Nu-Link Driver Download & Install

Please visit Nuvoton company NuMicro[™] website (<http://www.nuvoton.com/NuMicro>) to download “NuMicro[™] Keil μ Vision[®] IDE driver” file. Please refer the Chapter 6.1 for the detail download flow. When the Nu-Link driver have been download ok, please unzip the file and execute the “Nu-Link_Keil_Driver.exe” to install the driver.

3.3 Hardware Setup

The hardware setup is shown as Figure 3-1

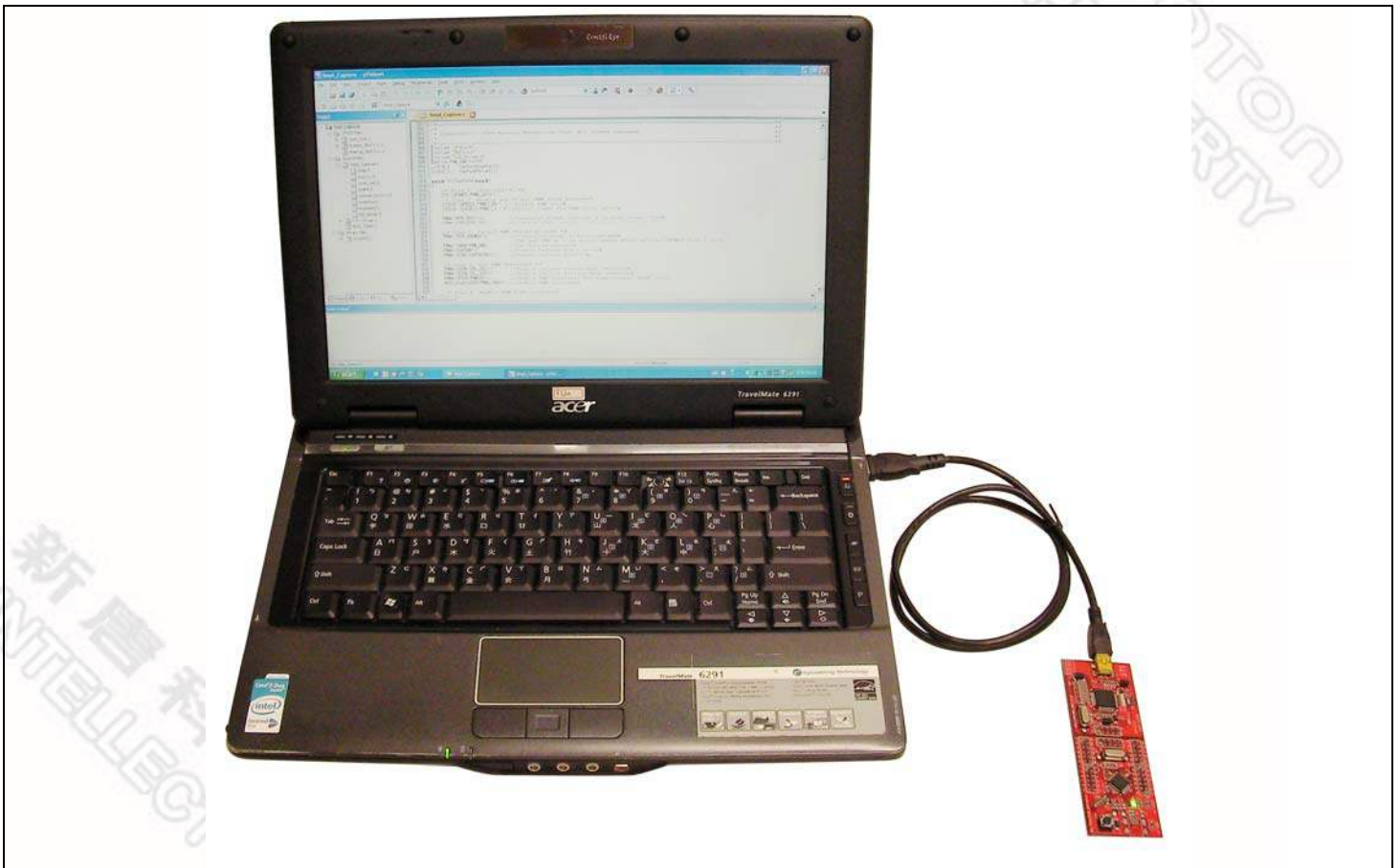

Figure 3-1 NuTiny-SDK-100 Hardware Setup

3.4 Smpl_NuTiny-NUC100 Example Program

This example demonstrates the ease of downloading and debugging an application on a NuTiny-SDK-100 board. It can be found on the Figure 3-2 list directory and downloaded from Nuvoton NuMicro™ Website following Chapter 6.3.

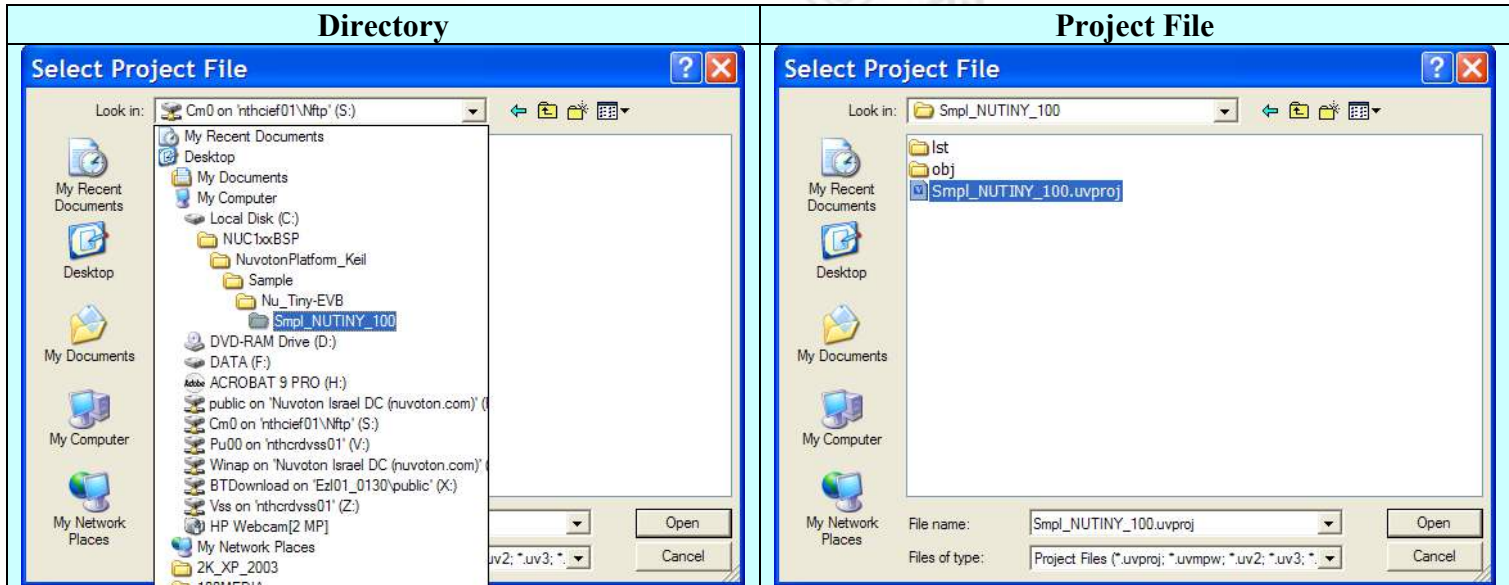









Figure 3-2 Smpl_NuTiny_100 Example Directory

To use this example:
The PC.3 LED will toggle on the NuTiny-EVB-100 board.

-  **Start µVision®**
- **Project-Open**
Open the Smpl_NuTiny_100.uvproj project file
-  **Project - Build**
Compile and link the Smpl_NuTiny-NUC100 application
-  **Flash – Download**
Program the application code into on-chip Flash ROM
-  **Start debug mode**
Using the debugger commands, you may:
 - ◆  Review variables in the watch window
 - ◆  Single step through code
 - ◆  RST Reset the device
 - ◆  Run the application

4 How to Start NuTiny-SDK-100 on the IAR Embedded Workbench

4.1 IAR Embedded Workbench Software Download and Install

Please connect to IAR company website (<http://www.iar.com>) to download the IAR Embedded Workbench and install the EWARM.

4.2 Nuvoton Nu-Link Driver Download and Install

Please connect to Nuvoton Company NuMicro™ website (<http://www.nuvoton.com/NuMicro>) to download “NuMicro™ IAR ICE driver user manual” file. Please refer the Chap6.2 for the detail download flow. When the Nu-Link driver have been download ok, please unzip the file and execute the “Nu-Link_IAR_Driver.exe” to install the driver.

4.3 Hardware Setup

The hardware setup is shown as Figure 4-1

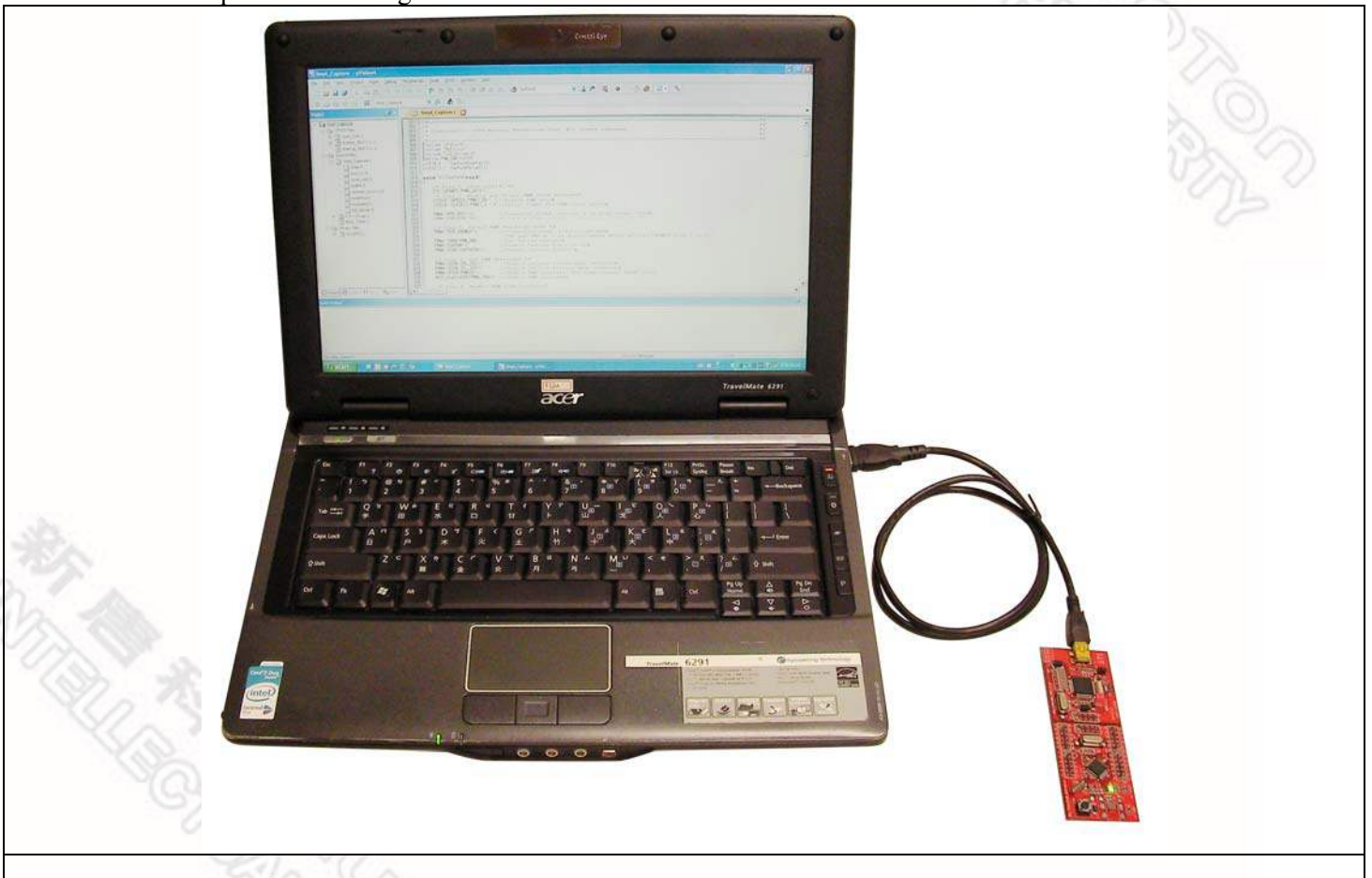

Figure 4-1 NuTiny- SDK-100 Hardware Setup

4.4 SmpI_NuTiny-NUC100 Example Program

This example demonstrates the ease of downloading and debugging an application on a NuTiny-SDK-100 board. It can be found on the Figure 4-2 list directory and downloaded from Nuvoton NuMicro™ Website following Chapter 6.3.

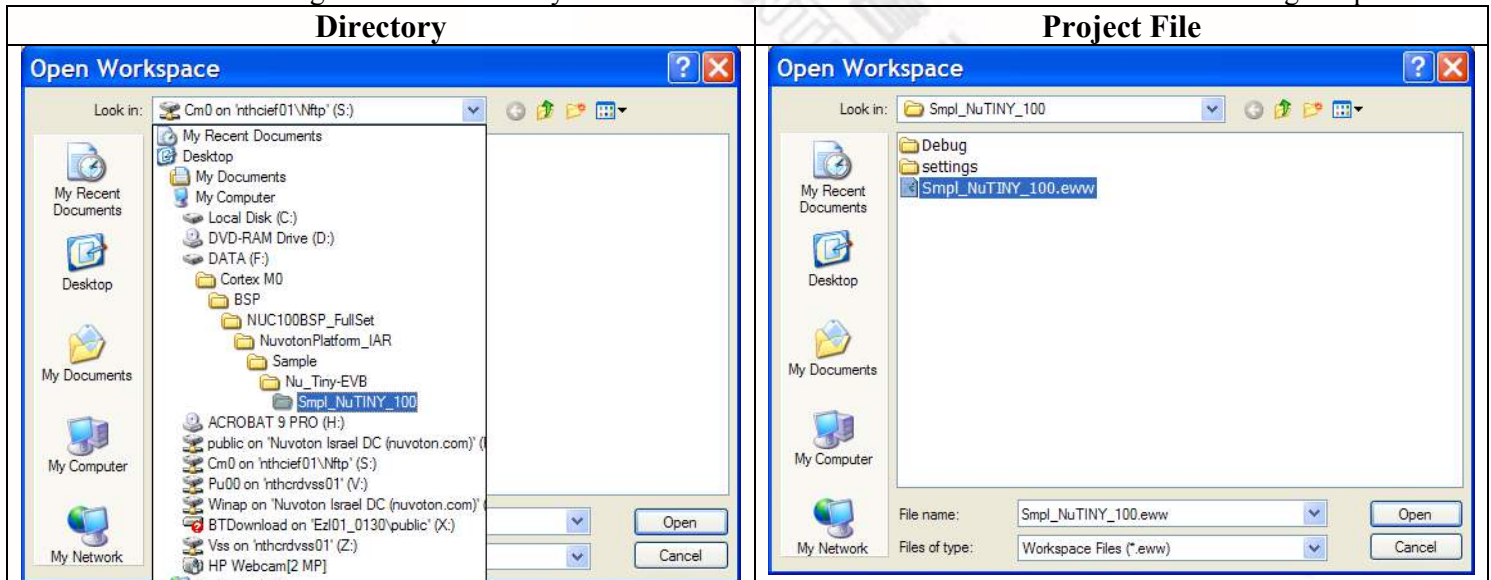



Figure 4-2 SmpI_NuTiny_100 Example Directory

To use this example:

The PC.3 LED will toggle on the NuTiny-EVB-100 board.

-  **Start IAR Embedded Workbench**

- **File-Open-Workspace**
Open the SmpI_NuTiny_100.eww workspace file

-  **Project - Make**
Compile and link the SmpI_NuTiny-100 application

-  **Project – Download and Debug**
Program the application code into on-chip Flash ROM.

- ◆  Single step through code

- ◆  Reset the device

- ◆  Run the application

5 NuTiny-EVB-100 Schematic

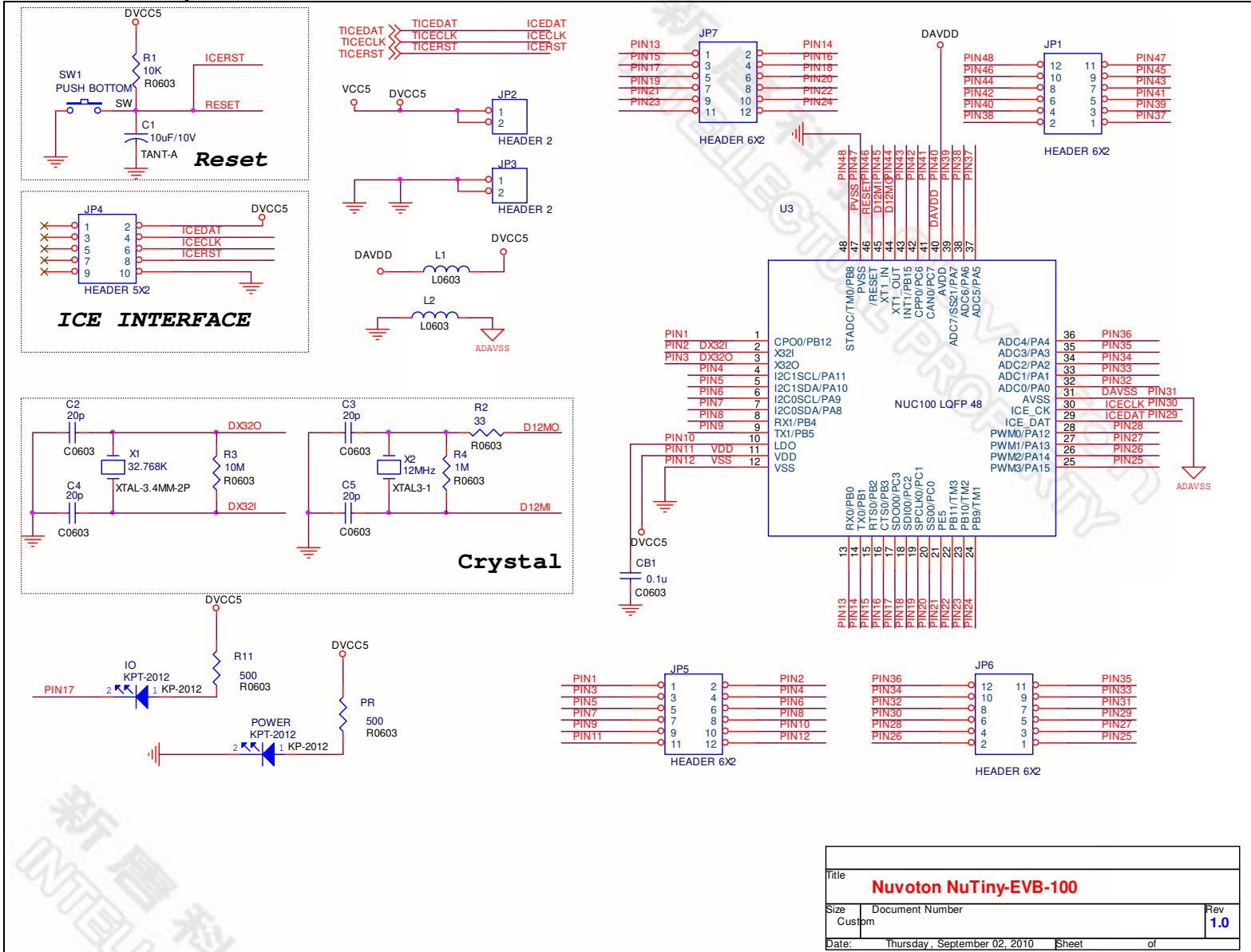

6 To Download NuMicro™ Family Related Files from Nuvoton Company

6.1 To Download NuMicro™ Keil μVision® IDE driver

<p>Step1</p>	<p>To visit the Nuvoton NuMicro™ Website: http://www.nuvoton.com/NuMicro</p>																																							
<p>Step2</p>	<p>ARM Cortex™-M0 NuMicro® Family</p> <p>Development Tools and Study</p> <ul style="list-style-type: none"> Development Tools & File Download On Line Training <p>NuMicro® Family</p> <ul style="list-style-type: none"> M051 Base Line Up to 94KB Flash, 16KB RAM Up to 490 I/Os • NuMicro M051 • Cortex-M0 NU100 Advance Line UMT 																																							
<p>Step 3</p>	<table border="1"> <tr> <td>Nu-LB</td> <td> <ul style="list-style-type: none"> Nu-LB </td> <td> NUC100 NUC120 NUC130 NUC140 </td> <td> <ul style="list-style-type: none"> A Starter Kit made by Nuvoton Keil MDK-ARM (evaluation version) included Examples with source code included </td> <td></td> <td>Check Disty!</td> </tr> <tr> <td>Nu-IAR-SKT</td> <td> <ul style="list-style-type: none"> EVB w/M-Link USB Cable Setup CD </td> <td> NUC100 NUC120 NUC130 NUC140 </td> <td> <ul style="list-style-type: none"> Starter Kit made by IAR IAR EWARM (evaluation version) Included IAR C/C++ Compiler included USB Plug & Play </td> <td></td> <td>Buy Online!</td> </tr> <tr> <td>Nu-Keil-SKT</td> <td> <ul style="list-style-type: none"> U-LINK-ME MCBNUC1XX USB Cable Setup CD </td> <td> NUC100 NUC120 NUC130 NUC140 </td> <td> <ul style="list-style-type: none"> Starter Kit made by Keil Keil MDK-ARM (evaluation version) included ARM C/C++ Compiler included USB Plug & Play </td> <td></td> <td>Check Disty!</td> </tr> </table> <p>File Download</p> <table border="1"> <thead> <tr> <th>File name</th> <th>Description</th> <th>Version</th> </tr> </thead> <tbody> <tr> <td> NUC1xx Quick Start Guide for Keil uVision4 V1.00.zip</td> <td>Quick start guide using Keil™ RVMDK</td> <td>V1.00</td> </tr> <tr> <td> NuMicro Keil uVision® IDE driver (Build 4033) V1.02.zip</td> <td>The Nuvoton NuMicro Keil uVision® Driver allows the Keil uVision® IDE to communicate with Nuvoton Nu-Link ICE bridge.</td> <td>V1.02</td> </tr> <tr> <td> NuMicro IAR Embedded Workbench® driver (Build 4033) V1.02.zip</td> <td>The Nuvoton NuMicro IAR Embedded Workbench® driver allows the IAR Embedded Workbench IDE above v5.41 to communicate with Nuvoton Nu-Link ICE bridge.</td> <td>V1.02</td> </tr> <tr> <td> NuMicro ICP (Build 4033) V1.02.zip</td> <td>NuMicro ICP tool & user manual</td> <td>V1.02</td> </tr> <tr> <td> NUC1xx ISP V1.08.zip</td> <td>NUC1xx ISP tool & user manual</td> <td>V1.08</td> </tr> <tr> <td> NIIC1xx Nu-EVB_001 Board Schematic v2.0.pdf</td> <td>NUC1xx Nu-EVB_001 Board Schematic</td> <td>V2.0</td> </tr> </tbody> </table> <p>To download the file</p>	Nu-LB	<ul style="list-style-type: none"> Nu-LB 	NUC100 NUC120 NUC130 NUC140	<ul style="list-style-type: none"> A Starter Kit made by Nuvoton Keil MDK-ARM (evaluation version) included Examples with source code included 		Check Disty!	Nu-IAR-SKT	<ul style="list-style-type: none"> EVB w/M-Link USB Cable Setup CD 	NUC100 NUC120 NUC130 NUC140	<ul style="list-style-type: none"> Starter Kit made by IAR IAR EWARM (evaluation version) Included IAR C/C++ Compiler included USB Plug & Play 		Buy Online!	Nu-Keil-SKT	<ul style="list-style-type: none"> U-LINK-ME MCBNUC1XX USB Cable Setup CD 	NUC100 NUC120 NUC130 NUC140	<ul style="list-style-type: none"> Starter Kit made by Keil Keil MDK-ARM (evaluation version) included ARM C/C++ Compiler included USB Plug & Play 		Check Disty!	File name	Description	Version	NUC1xx Quick Start Guide for Keil uVision4 V1.00.zip	Quick start guide using Keil™ RVMDK	V1.00	NuMicro Keil uVision® IDE driver (Build 4033) V1.02.zip	The Nuvoton NuMicro Keil uVision® Driver allows the Keil uVision® IDE to communicate with Nuvoton Nu-Link ICE bridge.	V1.02	NuMicro IAR Embedded Workbench® driver (Build 4033) V1.02.zip	The Nuvoton NuMicro IAR Embedded Workbench® driver allows the IAR Embedded Workbench IDE above v5.41 to communicate with Nuvoton Nu-Link ICE bridge.	V1.02	NuMicro ICP (Build 4033) V1.02.zip	NuMicro ICP tool & user manual	V1.02	NUC1xx ISP V1.08.zip	NUC1xx ISP tool & user manual	V1.08	NIIC1xx Nu-EVB_001 Board Schematic v2.0.pdf	NUC1xx Nu-EVB_001 Board Schematic	V2.0
Nu-LB	<ul style="list-style-type: none"> Nu-LB 	NUC100 NUC120 NUC130 NUC140	<ul style="list-style-type: none"> A Starter Kit made by Nuvoton Keil MDK-ARM (evaluation version) included Examples with source code included 		Check Disty!																																			
Nu-IAR-SKT	<ul style="list-style-type: none"> EVB w/M-Link USB Cable Setup CD 	NUC100 NUC120 NUC130 NUC140	<ul style="list-style-type: none"> Starter Kit made by IAR IAR EWARM (evaluation version) Included IAR C/C++ Compiler included USB Plug & Play 		Buy Online!																																			
Nu-Keil-SKT	<ul style="list-style-type: none"> U-LINK-ME MCBNUC1XX USB Cable Setup CD 	NUC100 NUC120 NUC130 NUC140	<ul style="list-style-type: none"> Starter Kit made by Keil Keil MDK-ARM (evaluation version) included ARM C/C++ Compiler included USB Plug & Play 		Check Disty!																																			
File name	Description	Version																																						
NUC1xx Quick Start Guide for Keil uVision4 V1.00.zip	Quick start guide using Keil™ RVMDK	V1.00																																						
NuMicro Keil uVision® IDE driver (Build 4033) V1.02.zip	The Nuvoton NuMicro Keil uVision® Driver allows the Keil uVision® IDE to communicate with Nuvoton Nu-Link ICE bridge.	V1.02																																						
NuMicro IAR Embedded Workbench® driver (Build 4033) V1.02.zip	The Nuvoton NuMicro IAR Embedded Workbench® driver allows the IAR Embedded Workbench IDE above v5.41 to communicate with Nuvoton Nu-Link ICE bridge.	V1.02																																						
NuMicro ICP (Build 4033) V1.02.zip	NuMicro ICP tool & user manual	V1.02																																						
NUC1xx ISP V1.08.zip	NUC1xx ISP tool & user manual	V1.08																																						
NIIC1xx Nu-EVB_001 Board Schematic v2.0.pdf	NUC1xx Nu-EVB_001 Board Schematic	V2.0																																						
<p>Step 4</p>	<p>To download the NuMicro Keil μVision® IDE driver</p>																																							

6.2 To Download NuMicro™ IAR EWARM driver

<p>Step1</p>	<p>To visit the Nuvoton NuMicro™ Website: http://www.nuvoton.com/NuMicro</p>																																							
<p>Step2</p>	<p>ARM Cortex™-M0 NuMicro® Family</p> <p>NuMicro® Family is Nuvoton's brand-new 32-bit Microcontroller product line based on the ARM® Cortex™-M0 processor with rich peripherals to offer superb features and connectivity solutions. Besides the NUC100, NUC120, NUC130 and NUC140 series, a new series the NuMicro M051™ series, including the M051A4/S0/S16 to satisfy the worldwide customers' 8-bit/16-bit microcontroller demand with a higher performance of a 32-bit microcontroller.</p> <p>Technical Library</p> <ul style="list-style-type: none"> On-Line Products Selection Guide Datasheet & Technical Reference Manual Software Library Application Notes FAQ <p>Development Tools and Study</p> <ul style="list-style-type: none"> Development Tools & File Download On-Line Training <p>Information Notes</p> <ul style="list-style-type: none"> Events E-news M051 Series T8M New M051 Series RSP by CMSIS New NuMicro Keil uVision® IDE Driver New <p>NuMicro® Family</p> <p>M051 Down Line</p> <ul style="list-style-type: none"> Up to 60K Flash (1T8M) Up to 400 T8RAM NuMicro M051 Cortex-M0 <p>NUC100 Advance Line</p> <ul style="list-style-type: none"> U-Link 																																							
<p>Step 3</p>	<table border="1"> <tr> <td>Nu-LB</td> <td> <ul style="list-style-type: none"> Nu-LB </td> <td>NUC100 NUC120 NUC130 NUC140</td> <td> <ul style="list-style-type: none"> A Starter Kit made by Nuvoton Keil MDK-ARM (evaluation version) included Examples with source code included </td> <td></td> <td>Check Disty!</td> </tr> <tr> <td>Nu-IAR-SKT</td> <td> <ul style="list-style-type: none"> EVB w/M-Link USB Cable Setup CD </td> <td>NUC100 NUC120 NUC130 NUC140</td> <td> <ul style="list-style-type: none"> Starter Kit made by IAR IAR EWARM (evaluation version) Included IAR C/C++ Compiler included USB Plug & Play </td> <td></td> <td>Buy Online!</td> </tr> <tr> <td>Nu-Keil-SKT</td> <td> <ul style="list-style-type: none"> U-LINK-ME MCBNUC1XX USB Cable Setup CD </td> <td>NUC100 NUC120 NUC130 NUC140</td> <td> <ul style="list-style-type: none"> Starter Kit made by Keil Keil MDK-ARM (evaluation version) included ARM C/C++ Compiler included USB Plug & Play </td> <td></td> <td>Check Disty!</td> </tr> </table> <p>File Download</p> <table border="1"> <thead> <tr> <th>File name</th> <th>Description</th> <th>Version</th> </tr> </thead> <tbody> <tr> <td> NUC1xx Quick Start Guide for Keil uVision4 V1.00.zip</td> <td>Quick start guide using Keil™ RVMKD</td> <td>V1.00</td> </tr> <tr> <td> NuMicro Keil uVision® IDE driver (Build 4033) V1.02.zip</td> <td>The Nuvoton NuMicro Keil uVision® Driver allows the Keil uVision® IDE to communicate with Nuvoton Nu-Link ICE bridge.</td> <td>V1.02</td> </tr> <tr> <td> NuMicro IAR Embedded Workbench® driver (Build 4033) V1.02.zip</td> <td>The Nuvoton NuMicro IAR Embedded Workbench® driver allows the IAR Embedded Workbench IDE above v5.41 to communicate with Nuvoton Nu-Link ICE bridge.</td> <td>V1.02</td> </tr> <tr> <td> NuMicro ICP (Build 4033) V1.02.zip</td> <td>NuMicro ICP tool & user manual</td> <td>V1.02</td> </tr> <tr> <td> NUC1xx ISP V1.08.zip</td> <td>NUC1xx ISP tool & user manual</td> <td>V1.08</td> </tr> <tr> <td> NIIC1xx Nu-EVB_001 Board Schematic v2.0.nff</td> <td>NUC1xx Nu-EVB_001 Board Schematic</td> <td>V2.0</td> </tr> </tbody> </table> <p>To download the file</p>	Nu-LB	<ul style="list-style-type: none"> Nu-LB 	NUC100 NUC120 NUC130 NUC140	<ul style="list-style-type: none"> A Starter Kit made by Nuvoton Keil MDK-ARM (evaluation version) included Examples with source code included 		Check Disty!	Nu-IAR-SKT	<ul style="list-style-type: none"> EVB w/M-Link USB Cable Setup CD 	NUC100 NUC120 NUC130 NUC140	<ul style="list-style-type: none"> Starter Kit made by IAR IAR EWARM (evaluation version) Included IAR C/C++ Compiler included USB Plug & Play 		Buy Online!	Nu-Keil-SKT	<ul style="list-style-type: none"> U-LINK-ME MCBNUC1XX USB Cable Setup CD 	NUC100 NUC120 NUC130 NUC140	<ul style="list-style-type: none"> Starter Kit made by Keil Keil MDK-ARM (evaluation version) included ARM C/C++ Compiler included USB Plug & Play 		Check Disty!	File name	Description	Version	NUC1xx Quick Start Guide for Keil uVision4 V1.00.zip	Quick start guide using Keil™ RVMKD	V1.00	NuMicro Keil uVision® IDE driver (Build 4033) V1.02.zip	The Nuvoton NuMicro Keil uVision® Driver allows the Keil uVision® IDE to communicate with Nuvoton Nu-Link ICE bridge.	V1.02	NuMicro IAR Embedded Workbench® driver (Build 4033) V1.02.zip	The Nuvoton NuMicro IAR Embedded Workbench® driver allows the IAR Embedded Workbench IDE above v5.41 to communicate with Nuvoton Nu-Link ICE bridge.	V1.02	NuMicro ICP (Build 4033) V1.02.zip	NuMicro ICP tool & user manual	V1.02	NUC1xx ISP V1.08.zip	NUC1xx ISP tool & user manual	V1.08	NIIC1xx Nu-EVB_001 Board Schematic v2.0.nff	NUC1xx Nu-EVB_001 Board Schematic	V2.0
Nu-LB	<ul style="list-style-type: none"> Nu-LB 	NUC100 NUC120 NUC130 NUC140	<ul style="list-style-type: none"> A Starter Kit made by Nuvoton Keil MDK-ARM (evaluation version) included Examples with source code included 		Check Disty!																																			
Nu-IAR-SKT	<ul style="list-style-type: none"> EVB w/M-Link USB Cable Setup CD 	NUC100 NUC120 NUC130 NUC140	<ul style="list-style-type: none"> Starter Kit made by IAR IAR EWARM (evaluation version) Included IAR C/C++ Compiler included USB Plug & Play 		Buy Online!																																			
Nu-Keil-SKT	<ul style="list-style-type: none"> U-LINK-ME MCBNUC1XX USB Cable Setup CD 	NUC100 NUC120 NUC130 NUC140	<ul style="list-style-type: none"> Starter Kit made by Keil Keil MDK-ARM (evaluation version) included ARM C/C++ Compiler included USB Plug & Play 		Check Disty!																																			
File name	Description	Version																																						
NUC1xx Quick Start Guide for Keil uVision4 V1.00.zip	Quick start guide using Keil™ RVMKD	V1.00																																						
NuMicro Keil uVision® IDE driver (Build 4033) V1.02.zip	The Nuvoton NuMicro Keil uVision® Driver allows the Keil uVision® IDE to communicate with Nuvoton Nu-Link ICE bridge.	V1.02																																						
NuMicro IAR Embedded Workbench® driver (Build 4033) V1.02.zip	The Nuvoton NuMicro IAR Embedded Workbench® driver allows the IAR Embedded Workbench IDE above v5.41 to communicate with Nuvoton Nu-Link ICE bridge.	V1.02																																						
NuMicro ICP (Build 4033) V1.02.zip	NuMicro ICP tool & user manual	V1.02																																						
NUC1xx ISP V1.08.zip	NUC1xx ISP tool & user manual	V1.08																																						
NIIC1xx Nu-EVB_001 Board Schematic v2.0.nff	NUC1xx Nu-EVB_001 Board Schematic	V2.0																																						
<p>Step 4</p>	<p>To download the NuMicro™ IAR Embedded Workbench® driver</p>																																							

6.3 To Download NuMicro™ NUC100 series BSP Software Library

Step1	To visit the Nuvoton NuMicro™ Website: http://www.nuvoton.com/NuMicro
Step2	<p>ARM Cortex™-M0 NuMicro® Family</p> <p>NuMicro® Family is Nuvoton's brand-new 32-bit Microcontroller product line based on the ARM® Cortex™-M0 processor with rich peripherals to offer superb features and connectivity capability. Besides the NUC100, NUC120, NUC130 and NUC140 series, a new series the NuMicro M051™ series, including the M052/54/58/516 is to satisfy the worldwide customers' 8-bit/16-bit microcontroller demand with a higher performance of a 32-bit microcontroller.</p> <div style="display: flex; justify-content: space-between;"> <div data-bbox="261 1018 634 1188"> <p>Technical Library</p> <ul style="list-style-type: none"> On-Line Products Selection Guide Datasheet & Technical Reference Manual Software Library Application Notes FAQ </div> <div data-bbox="711 1018 1084 1188"> <p>Development Tools and Study</p> <ul style="list-style-type: none"> Development Tools & File Download Starter Kit On-Line Training </div> <div data-bbox="1161 1018 1534 1188"> <p>Information Notes</p> <ul style="list-style-type: none"> Events E-News M051 Series TRM New M051 Series BSP by CMSIS New NuMicro Keil uVision® IDE Driver New </div> </div> <p style="text-align: center;">NuMicro® Family</p> <div style="display: flex; justify-content: space-around; align-items: center;"> <div data-bbox="565 1360 787 1478"> <p>M051 Base Line</p> <ul style="list-style-type: none"> Up to 64KB Flash ROM Up to 4KB SRAM <p>NUC100 Advance Line</p> </div> <div data-bbox="803 1360 1063 1478" style="border: 1px solid red; padding: 5px;"> <p>• NuMicro M051 •</p> </div> <div data-bbox="1079 1360 1242 1478" style="border: 1px solid green; padding: 5px;"> <p>Cortex-M0</p> <p>UART</p> </div> </div>
Step 3	To download the NuMicro™ NUC100 series software library

7 Revision History

Version	Date	Page	Description
1.0	Aug. 20, 2010	--	Initial Release

Important Notice

Nuvoton products are not designed, intended, authorized or warranted for use as components in systems or equipment intended for surgical implantation, atomic energy control instruments, airplane or spaceship instruments, transportation instruments, traffic signal instruments, combustion control instruments, or for other applications intended to support or sustain life. Further more, Nuvoton products are not intended for applications wherein failure of Nuvoton products could result or lead to a situation wherein personal injury, death or severe property or environmental damage could occur.

Nuvoton customers using or selling these products for use in such applications do so at their own risk and agree to fully indemnify Nuvoton for any damages resulting from such improper use or sales.

Please note that all data and specifications are subject to change without notice. All the trademarks of products and companies mentioned in this datasheet belong to their respective owners.