

# SMD Inductors(Coils) For Power Line(Multilayer, Magnetic Shielded)

Conformity to RoHS Directive

## MLP Series MLP2520

In response to market demands for smaller mobile devices with a longer lasting life, mounted switching supply circuits with even higher frequencies are now being developed.

With optimized materials the MLP2520 type contributes to the improved efficiency of power sources, and reduces the losses caused by ferrite, even if the products are used for supply circuits with high drive frequencies.

### FEATURES

- Optimized ferrite materials enable the reduction of losses.
- Compared to the existing MLP2520 type, DC superposition characteristics have been substantially improved.
- The products contain no lead and also support lead-free soldering.
- It is a product conforming to RoHS directive.

### APPLICATIONS

Cellular phones, DSCs, DVCs, HDs, etc.

### SPECIFICATIONS

Operating temperature range	-40 to +125°C [Including self-temperature rise]
Storage temperature range	-40 to +85°C

### RECOMMENDED SOLDERING CONDITION REFLOW SOLDERING

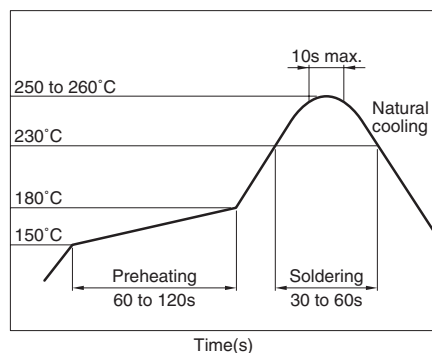

### PRODUCT IDENTIFICATION

MLP	2520	S	1R0	M	T
(1)	(2)	(3)	(4)	(5)	(6)

(1) Series name

(2) Dimensions L×W

2520	2.5×2.0mm
------	-----------

(3) Product characteristics classification code

S	STD
P	Improved DC superimposition characteristics

(4) Inductance value

1R0	1.0μH
1R5	1.5μH
2R2	2.2μH
3R3	3.3μH
4R7	4.7μH

• S1R0S: 1.2μH, S2R2S: 2.5μH

(5) Management number

M	t=1.0mm max.
S	t=1.2mm max.

(6) Packaging style

T	Taping [reel]
---	---------------

### PACKAGING STYLE AND QUANTITIES

Packaging style	Thickness T(mm)	Quantity
Taping	1.0mm max.	3000 pieces/reel
	1.2mm max.	3000 pieces/reel

### HANDLING AND PRECAUTIONS

- Before soldering, be sure to preheat components. The preheating temperature should be set so that the temperature difference between the solder temperature and product temperature does not exceed 150°C.
- After mounting components onto the printed circuit board, do not apply stress through board bending or mishandling.
- The inductance value may change due to magnetic saturation if the current exceeds the rated maximum.
- Do not expose the inductors to stray magnetic fields.
- Avoid static electricity discharge during handling.
- When hand soldering, apply the soldering iron to the printed circuit board only. Temperature of the iron tip should not exceed 350°C. Soldering time should not exceed 3 seconds.

• Conformity to RoHS Directive: This means that, in conformity with EU Directive 2002/95/EC, lead, cadmium, mercury, hexavalent chromium, and specific bromine-based flame retardants, PBB and PBDE, have not been used, except for exempted applications.

• Please contact our Sales office when your application are considered the following:  
The device's failure or malfunction may directly endanger human life (e.g. application for automobile/aircraft/medical/nuclear power devices, etc.)

• All specifications are subject to change without notice.

## SHAPES AND DIMENSIONS/RECOMMENDED PC BOARD PATTERN

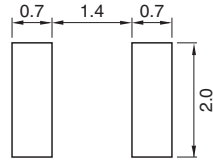
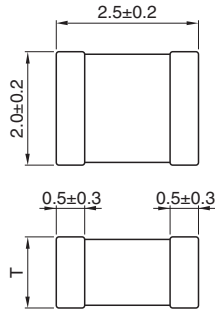

Dimensions in mm

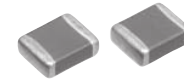

T(Thickness)	Weight(mg)
1.0max.	15
1.2max.	25

## ELECTRICAL CHARACTERISTICS

Type	Part No.	Inductance (μH)	Inductance tolerance	Test frequency (MHz)	DC resistance (Ω)±30%	Rated current (mA)	Thickness (mm)max.
General	MLP2520S1R0M	1.0	±20%	2	0.085	1500	1.0
	MLP2520S1R5M	1.5	±20%	2	0.09	1200	1.0
	MLP2520S2R2M	2.2	±20%	2	0.09	1200	1.0
	MLP2520S3R3M	3.3	±20%	2	0.13	1000	1.0
	MLP2520S4R7M	4.7	±20%	2	0.13	1000	1.0
Designed especially for DC superimposition	MLP2520P2R2M	2.2	±20%	2	0.12	1200	1.0
	MLP2520P4R7M	4.7	±20%	2	0.28	700	1.0
General	MLP2520S1R0S	1.2	±20%	2	0.08	1500	1.2
	MLP2520S2R2S	2.5	±20%	2	0.11	1200	1.2
	MLP2520S3R3S	3.3	±20%	2	0.11	1000	1.2
	MLP2520S4R7S	4.7	±20%	2	0.11	1000	1.2
Designed especially for DC superimposition	MLP2520P2R2S	2.2	±20%	2	0.17	1000	1.2
	MLP2520P4R7S	4.7	±20%	2	0.18	800	1.2

## TYPICAL ELECTRICAL CHARACTERISTICS

### INDUCTANCE CHANGE vs. DC SUPERPOSITION CHARACTERISTICS

T=1.2mm max.

MLP2520S-S series

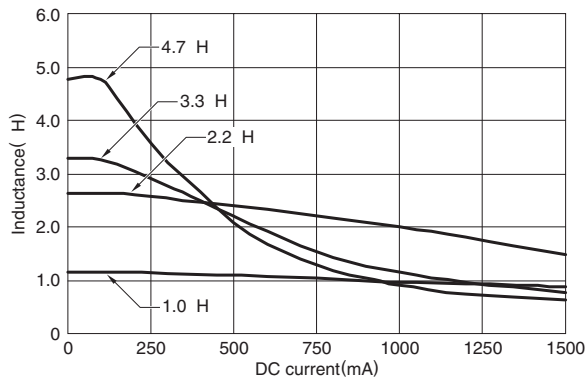

MLP2520P-S Series

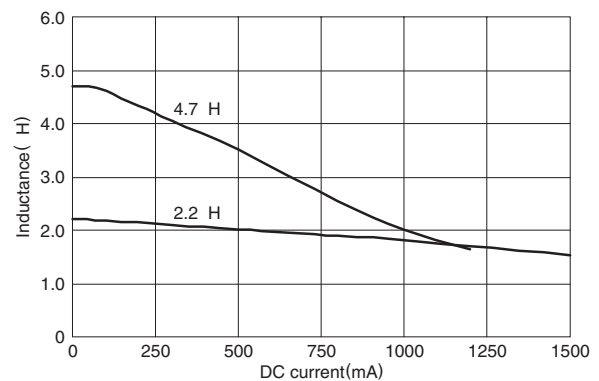

T=1.0mm max.

MLP2520S-M series

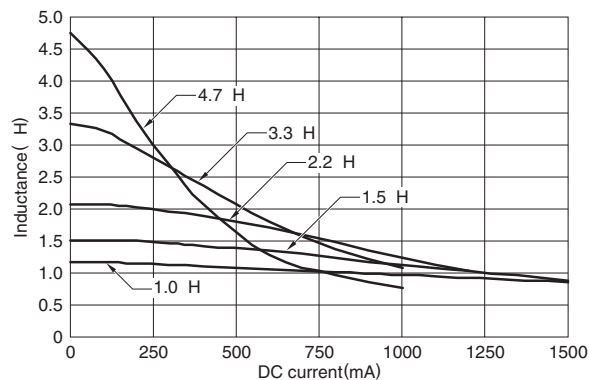

MLP2520P-M series

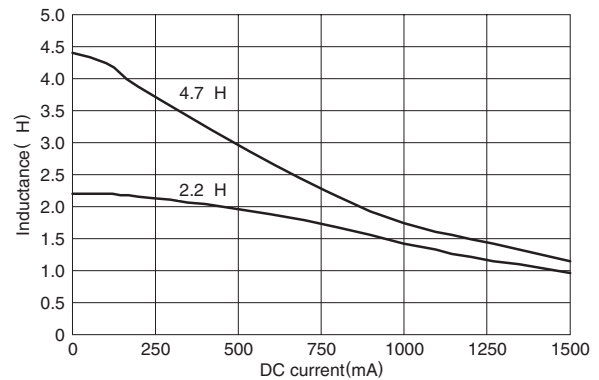

• All specifications are subject to change without notice.

### PACKAGING STYLES REEL DIMENSIONS

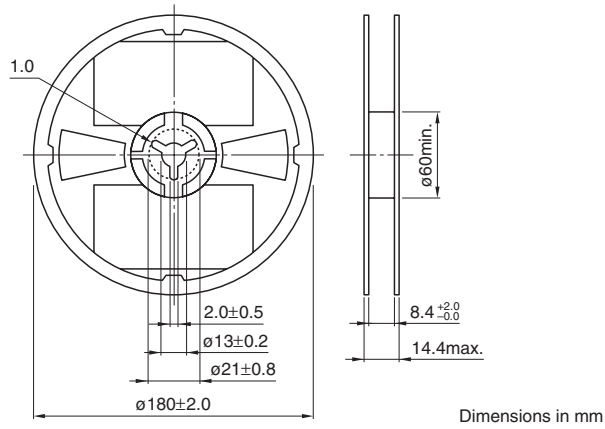

### TAPE DIMENSIONS

