

1.25 GHz to 2.60 GHz Digitally Tunable Band-Pass Filter

FEATURES

- ▶ Digitally tunable, octave, band-pass tuning
- ▶ 3 dB bandwidth: 9% ± 2%
- ▶ Rejection (20 dB): 16% away from f_{CENTER}
- ▶ Single chip replacement for discrete filter banks
- ▶ Compact 10 mm × 10 mm × 1.99 mm LGA package

APPLICATIONS

- ▶ Land mobile radios
- ▶ Test and measurement equipment
- ▶ Military radars and electronic warfare and electronic counter-measures
- ▶ Satellite communications
- ▶ Industrial and medical equipment

GENERAL DESCRIPTION

The ADMV8526 is an RF band-pass filter that features a digitally selectable frequency of operation. The filter center frequency (f_{CENTER}) can be adjusted from 1.25 GHz to 2.60 GHz, using an 8-bit value (256 states) that incorporates a patent pending interpolation technique.

The typical 3 dB bandwidth is 9% and adjustability is ±2%. Insertion loss is typically 4 dB, and the 20 dB rejection is 16% away from f_{CENTER} , which is ideally suited for minimizing system interferers.

This tunable filter can be used as a smaller alternative to large switched filter banks and discrete component-based tunable filters, and this device provides a dynamically adjustable solution in advanced communications applications.

FUNCTIONAL BLOCK DIAGRAM

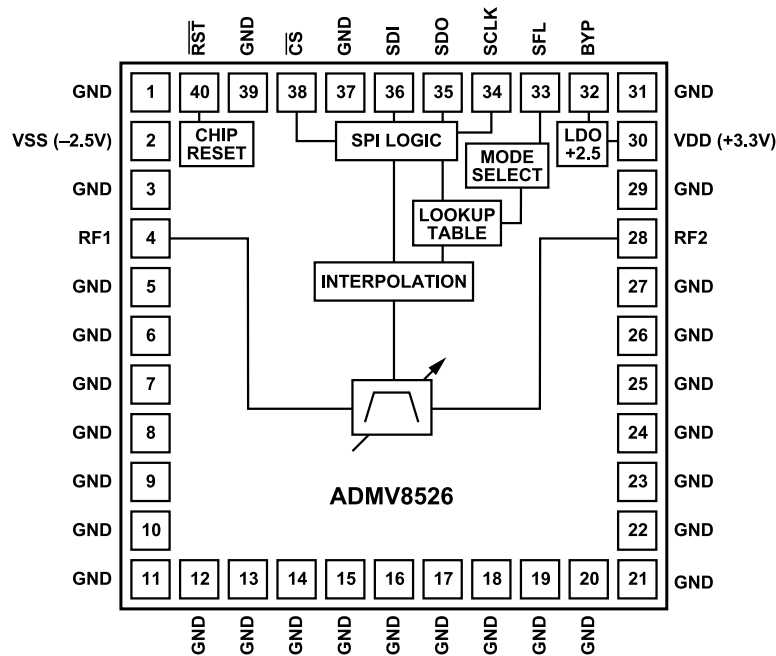

Figure 1.

001

TABLE OF CONTENTS

Features.....	1	Interpolation Functions.....	11
Applications.....	1	Interpolation Equations.....	12
General Description.....	1	Interpolation Tables.....	12
Functional Block Diagram.....	1	Interpolation Plots.....	13
Specifications.....	3	Interpolation Coefficient Calibration.....	13
Timing Specifications.....	4	Filter Code Read Back.....	13
Absolute Maximum Ratings.....	5	SPI Fast Latch Mode.....	14
Electrostatic Discharge (ESD) Ratings.....	5	Chip Reset.....	14
ESD Caution.....	5	Applications Information.....	15
Pin Configuration and Function Descriptions.....	6	Interpolation Coefficients.....	15
Typical Performance Characteristics.....	7	Printed Circuit Board (PCB) Design	
Theory of Operation.....	10	Guidelines.....	15
Chip Architecture.....	10	Flow Charts.....	16
RF Connections.....	10	Register Summary.....	17
SPI Configuration.....	10	Register Details.....	20
Mode Selection.....	11	Outline Dimensions.....	31
SPI Write Mode.....	11	Ordering Guide.....	31
SPI Streaming.....	11	Evaluation Boards.....	31

REVISION HISTORY**11/2021—Revision 0: Initial Version**

SPECIFICATIONS

$T_A = 25^\circ\text{C}$, unless otherwise noted.

Table 1.

Parameter	Min	Typ	Max	Unit	Test Conditions/Comments	
FREQUENCY RANGE (f_{CENTER})	1.25		2.60	GHz		
BANDWIDTH (3 dB)		9		%		
BANDWIDTH ADJUSTABILITY		± 2		%		
RESOLUTION		1		%	8 bits per filter	
REJECTION (20 dB)						
Low-Side		$0.84 \times f_{\text{CENTER}}$		GHz		
High-Side		$1.16 \times f_{\text{CENTER}}$		GHz		
RE-ENTRY FREQUENCY		>4		GHz	≤ 30 dB	
INSERTION LOSS		4		dB		
RETURN LOSS		20		dB		
DYNAMIC PERFORMANCE						
Input Compression (P0.1dB)		24		dBm	Input power (P_{IN}) is 5 dBm, 100 kHz tone separation	
Input Third-Order Intercept (IP3)		43		dBm		
Group Delay		3.1		ns		
Amplitude Settling Time		2		μs		To within ≤ 1 dB of static insertion loss
Phase Settling Time		12		μs		To within $\leq 2^\circ$ of static phase
Drift Rate						
Amplitude		-0.007		dB/ $^\circ\text{C}$	At $f_{\text{CENTER}} = 1.9$ GHz	
Frequency		-75		ppm/ $^\circ\text{C}$		
RESIDUAL PHASE NOISE						
At 1 MHz Offset		-169		dBc/Hz	At $f_{\text{CENTER}} = 1.9$ GHz	
SUPPLY VOLTAGE						
VSS	-2.6	-2.5	-2.4	V		
VDD	+3.2	+3.3	+3.4	V		
SUPPLY CURRENT (STATIC)						
Static						
VSS Current (I_{SS})		2		μA		
VDD Current (I_{DD})		125		μA		
Dynamic						
I_{DD}		$f_{\text{SCLK}}/4$		mA	Where f_{SCLK} is the SCLK toggle frequency in MHz, for example, continuous serial peripheral interface (SPI) writing at 10 MHz yields 2.5 mA of dynamic supply current	
LOGIC ($\overline{\text{RST}}$, $\overline{\text{CS}}$, SCLK, SDI, SDO, and SFL)						
Logic Low	-0.3	0	+0.8	V		
Logic High	+1.2	+3.3	+3.6	V		

SPECIFICATIONS

TIMING SPECIFICATIONS

Table 2.

Parameter	Min	Typ	Max	Unit	Test Conditions / Comments
t ₁	10			ns	RST low time to perform reset
	10			ns	SCLK cycle time (write)
t ₂	20			ns	SCLK cycle time (read)
t ₃	2.5			ns	SCLK high time
t ₄	2.5			ns	SCLK low time
t ₅	5			ns	CS falling edge to SCLK rising edge setup time
t ₆	2			ns	SCLK rising edge to hold time
t ₇	5			ns	Minimum CS high time for latching in data (for multiple SPI transactions)
t ₈	5			ns	CS rising edge to next SCLK rising edge ignore
t ₉	5			ns	SDI data setup time
t ₁₀	2			ns	SDI data hold time
t ₁₁	10			ns	SFL falling edge (exiting SFL mode) to CS falling edge time (start of SPI transaction)
t ₁₂	10			ns	CS rising edge (end of SPI transaction) to SFL rising edge time (entering SFL mode)
t ₁₃	10			ns	SFL rising edge to CS falling edge time
t ₁₄	10			ns	CS cycle time (SFL mode)
t ₁₅	2.5			ns	CS high time (SFL mode)
t ₁₆	2.5			ns	CS low time (SFL mode)
t ₁₇		6		ns	SCLK falling edge to SDO valid (load capacitance (C _L) = 10 pF)
t ₁₈		5		ns	SDO rise and fall time (C _L = 10 pF)
t ₁₉		4		ns	CS rising edge to SDO tristate (C _L = 10 pF)

Timing Diagram

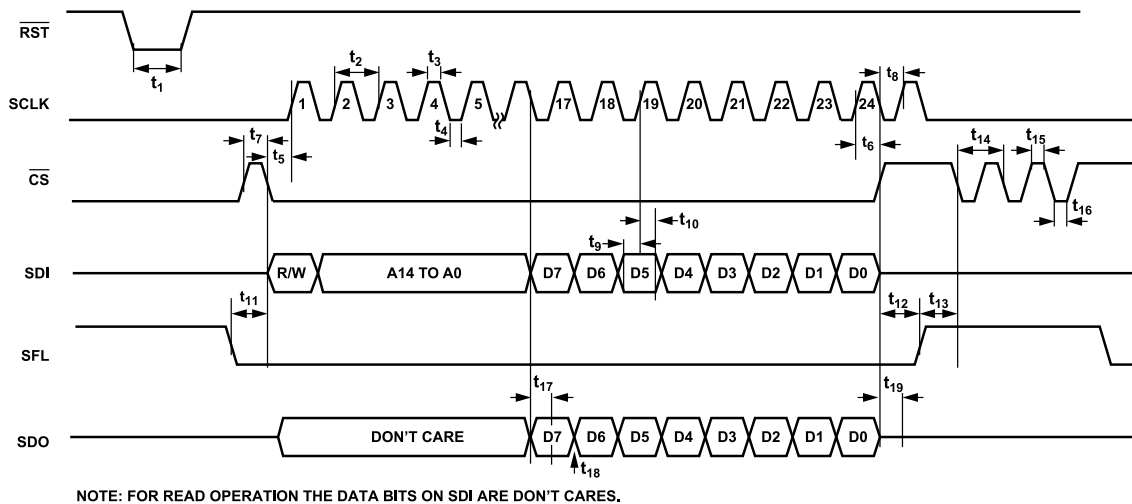

Figure 2. Timing Diagram

ABSOLUTE MAXIMUM RATINGS

Table 3.

Parameter	Rating
SUPPLY	
VDD	-0.3 V to +3.6 V
VSS	-3.6 V to +0.3 V
Digital Control Inputs	
Voltage	-0.3 V to VDD + 0.3 V
Current	2 mA
Continuous RF Input Power	
Survivability	24 dBm Maximum 5 minutes over lifetime
Temperature	
Operating Range	-40°C to +85°C
Storage Range	-55°C to +150°C
Junction to Maintain 1 Million Hours Mean Time to Failure (MTTF)	135°C
Nominal Junction (Paddle Temperature (T _{PADDLE}) = 85°C)	90°C
Moisture Sensitivity Level (MSL) Rating	MSL3

Stresses at or above those listed under Absolute Maximum Ratings may cause permanent damage to the product. This is a stress rating only; functional operation of the product at these or any other conditions above those indicated in the operational section of this specification is not implied. Operation beyond the maximum operating conditions for extended periods may affect product reliability.

ELECTROSTATIC DISCHARGE (ESD) RATINGS

The following ESD information is provided for handling of ESD-sensitive devices in an ESD protected area only.

Human body model (HBM) per ANSI/ESDA/JEDEC JS-001-2010.

Field induced charged device model (FICDM) per ANSI/ESDA/JEDEC JS-002.

ESD Ratings for ADMV8526

Table 4. ADMV8526, 40-Terminal LGA

ESD Model	Withstand Threshold (V)	Class
HBM	750	1B
FICDM	1000	C3

ESD CAUTION



ESD (electrostatic discharge) sensitive device. Charged devices and circuit boards can discharge without detection. Although this product features patented or proprietary protection circuitry, damage may occur on devices subjected to high energy ESD. Therefore, proper ESD precautions should be taken to avoid performance degradation or loss of functionality.

TYPICAL PERFORMANCE CHARACTERISTICS

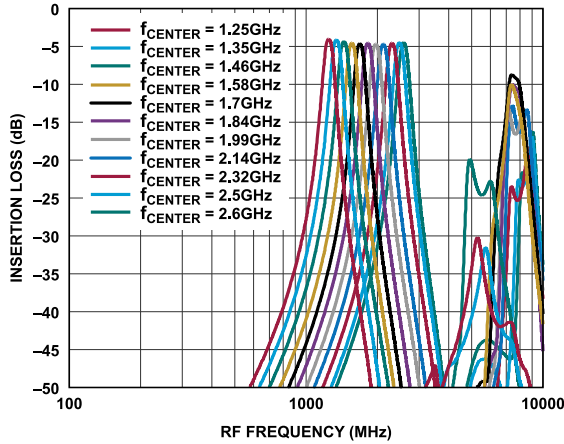

Figure 4. Insertion Loss vs. RF Frequency for Nominal 9% Bandwidth

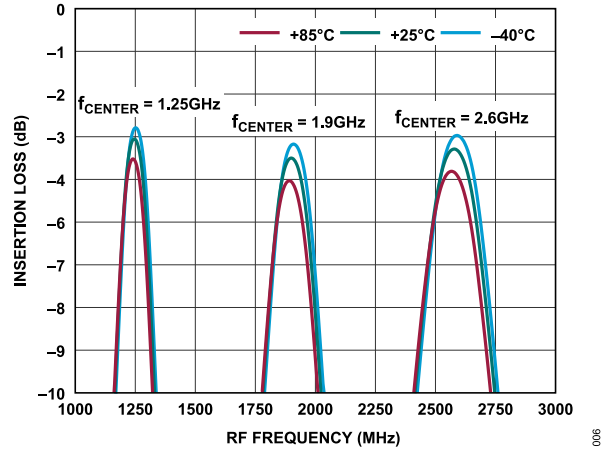

Figure 7. Insertion Loss vs. RF Frequency for Nominal 9% Bandwidth at Various Temperatures and Center Frequencies

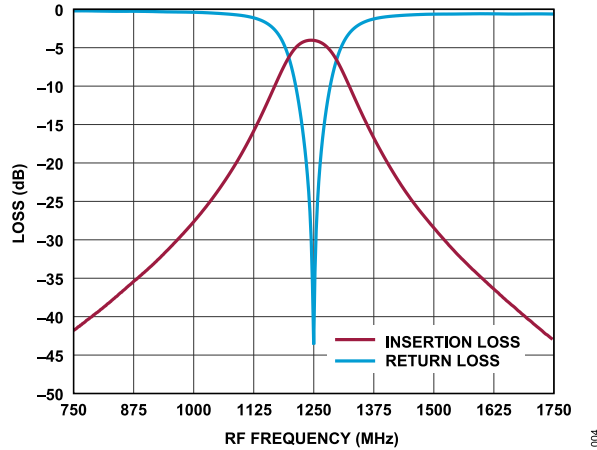

Figure 5. Insertion Loss and Return Loss vs. RF Frequency for Nominal 9% Bandwidth at 1.25 GHz

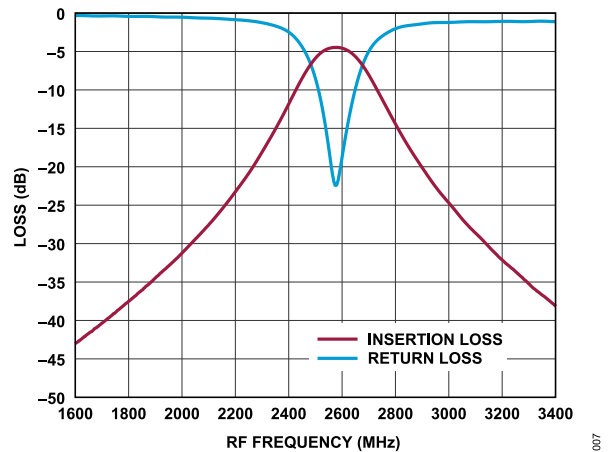

Figure 8. Insertion Loss and Return Loss vs. RF Frequency for Nominal 9% Bandwidth at 2.6 GHz

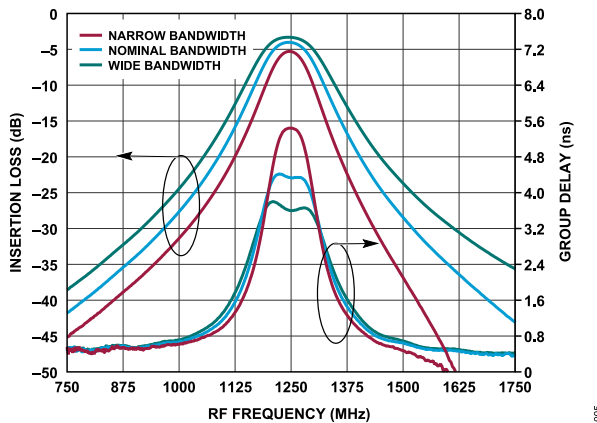

Figure 6. Insertion Loss and Group Delay vs. RF Frequency at 1.25 GHz

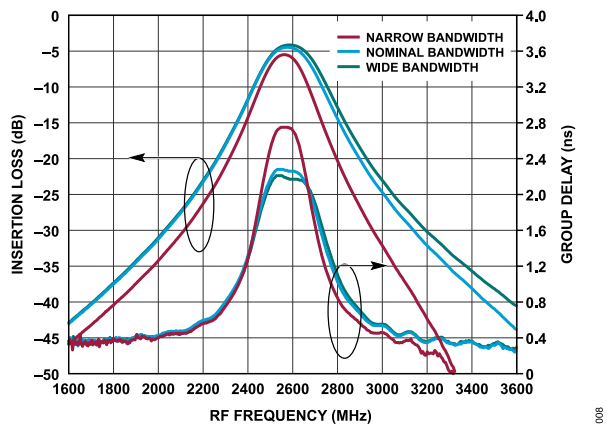

Figure 9. Insertion Loss and Group Delay vs. RF Frequency at 2.6 GHz

TYPICAL PERFORMANCE CHARACTERISTICS

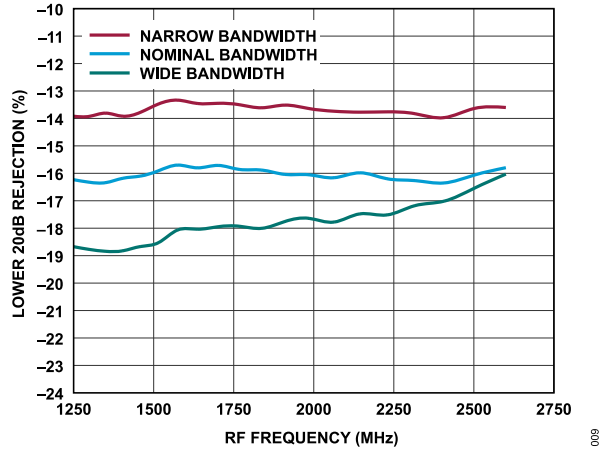

Figure 10. Percentage Away from f_{CENTER} for Lower 20 dB Rejection vs. RF Frequency for Various Bandwidths

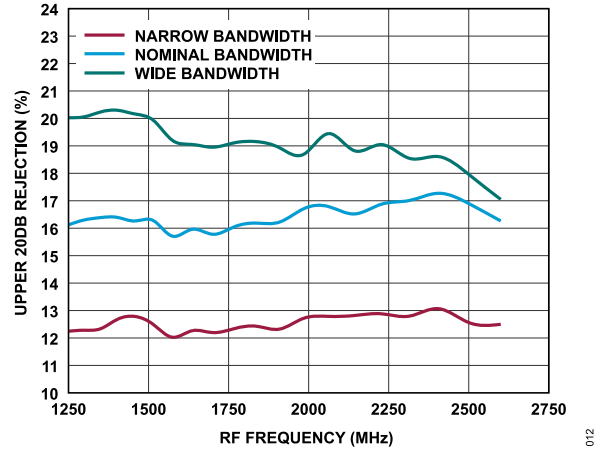

Figure 13. Percentage Away from f_{CENTER} for Upper 20 dB Rejection vs. RF Frequency for Various Bandwidths

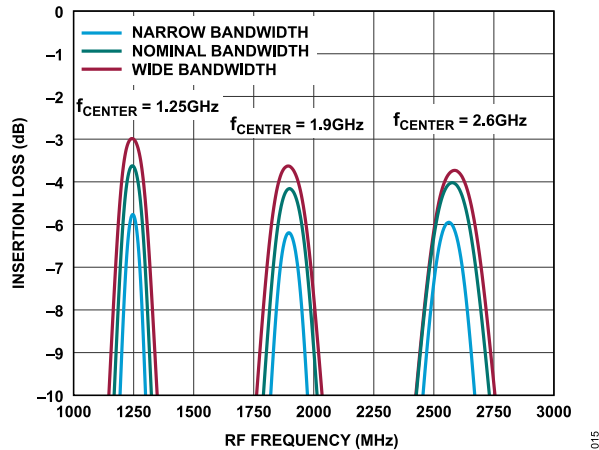

Figure 11. Insertion Loss vs. RF Frequency at Various Bandwidths and Center Frequencies

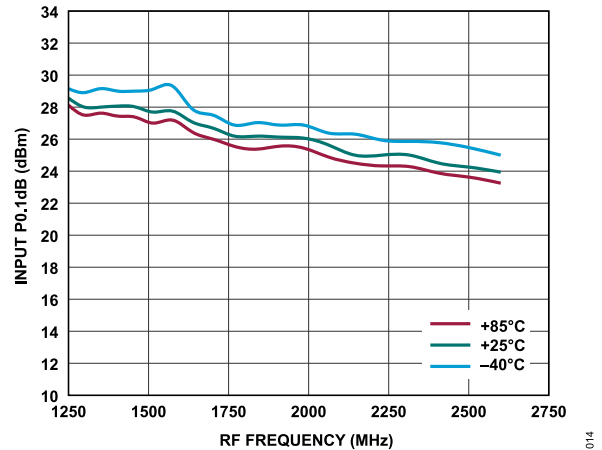

Figure 14. Input P0.1dB vs. RF Frequency for Nominal 9% Bandwidth and Various Temperatures

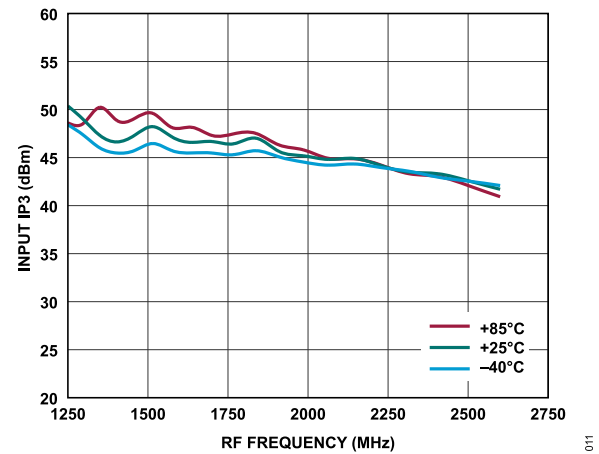

Figure 12. Input IP3 vs. RF Frequency for Nominal 9% Bandwidth and Various Temperatures

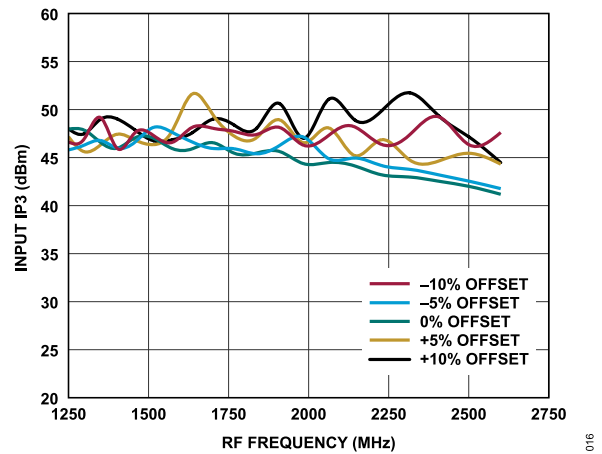

Figure 15. Input IP3 vs. RF Frequency for Nominal 9% Bandwidth and Various Frequency Offsets

TYPICAL PERFORMANCE CHARACTERISTICS

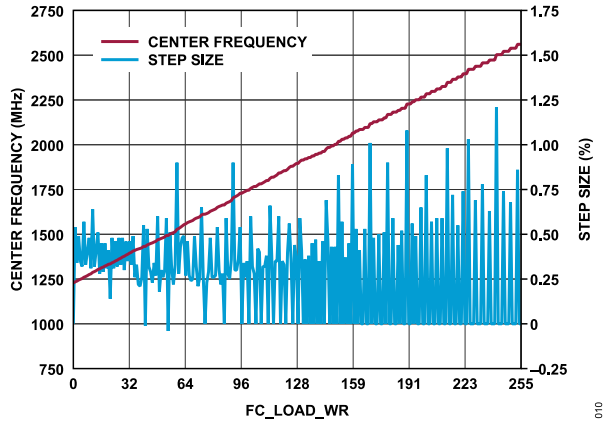

Figure 16. Center Frequency and Step Size vs. FC_LOAD_WR

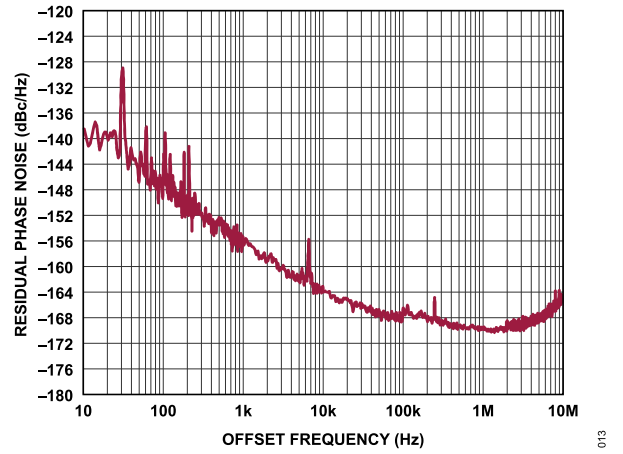

Figure 17. Residual Phase Noise vs. Offset Frequency for $f_{CENTER} = 1.9$ GHz

THEORY OF OPERATION

CHIP ARCHITECTURE

The ADMV8526 contains several switched capacitors that allow the RF performance to vary. A simplified diagram of the filter architecture is shown in Figure 18.

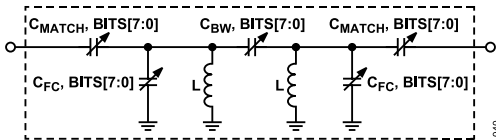

Figure 18. Simplified Filter Architecture Diagram

The two center frequency capacitors (C_{FC}) are configured by the f_{CENTER} load value, which manipulates the f_{CENTER} of the filter. Likewise, the bandwidth capacitor (C_{BW}) is configured by the bandwidth load value, which adjusts the bandwidth response of the filter. Additionally, the two match capacitors (C_{MATCH}) are set by the match load value, which allows adjustments to impedance matching of the filter.

The f_{CENTER} , bandwidth, and match load values each have 256 states (8 bits). In theory, there are over 16 million possible states for f_{CENTER} , bandwidth, and match load values for each band within the ADMV8526. To simplify selection of these values, Analog Devices has developed three patent pending interpolation functions to ease implementation.

RF CONNECTIONS

The RF1 and RF2 pins of the ADMV8526 are dc-coupled to on-chip ESD protection diodes. If a dc voltage is present on the RF1 and RF2 pins from other components within the system, it is recommended to place dc blocking capacitors in series with these pins. The dc blocking capacitors must be selected based on the operating frequency of the filter. Generally, a value greater than 10 nF is sufficient to minimize insertion loss at the lower frequencies of operation. At higher frequencies of operation, it may be necessary to consider the parasitic elements of the selected capacitor. Figure 19 shows a general model of a capacitor with the parasitic elements. The parasitic series inductance (L_{ESL}) is typically of most concern given that its impedance can become dominant. The other parasitic elements, including the leakage resistance (R_L), the dielectric absorption resistance (R_{DA}), the dielectric absorption capacitance (C_{DA}), and electrical series resistance (R_{ESR}) are less critical elements for consideration but are shown in Figure 19 for completeness.

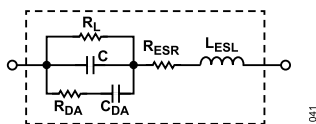

Figure 19. Model of a Capacitor

SPI CONFIGURATION

The SPI of the ADMV8526 allows configuration of the device for specific functions or operations via the 5-pin SPI port. This interface provides users with added flexibility and customization. The SPI consists of five control lines: SFL, SCLK, SDI, SDO, and \overline{CS} . For normal SPI operations, keep the SFL pin low.

The SPI protocol consists of an R/W bit followed by 15 register address bits and 8 data bits. The address field and data field are organized MSB first and end with the LSB.

Set the MSB to 0 for a write operation and set the MSB to 1 for a read operation. The write cycle must be sampled on the rising edge of SCLK. The 24 bits of the serial write address and data are shifted in on the SDI control line, MSB to LSB. The ADMV8526 input logic level for the write cycle supports a 3.3 V interface.

For a read cycle, the R/W bit and the 15 register address bits shift in on the rising edge of SCLK on the SDI control line. Then, 8 bits of serial read data shift out on the SDO control line, MSB first, on the falling edge of SCLK. The output logic level for a read cycle is 3.3 V. The output drivers of the SDO are enabled after the last rising edge of SCLK of the instruction cycle and remain active until the end of the read cycle. In a read operation, when \overline{CS} is deasserted, SDO returns to high impedance until the next read transaction. \overline{CS} is active low and must be deasserted at the end of the write or read sequence.

An active low input on \overline{CS} starts and gates a communication cycle. The \overline{CS} pin allows more than one device to be used on the same serial communications lines. The SDO pin goes to a high impedance state when the \overline{CS} input is high. During the communication cycle, the chip select must stay low. The SPI communications protocol follows the Analog Devices SPI standard. For more information, see the [ADI-SPI Serial Control Interface Standard \(Rev 1.0\)](#).

THEORY OF OPERATION

MODE SELECTION

The ADMV8526 has two modes of operation: SPI write and SPI fast latch. SPI write mode is the normal operating mode, whereas SPI fast latch mode is used to sequence through the on-chip lookup table (LUT) using the internal state machine. To select SPI write mode, set the SFL pin low. For operation in SPI fast latch mode, program the on-chip lookup table and fast latch parameters with the SFL pin low, and then bring the SFL pin high to enter this mode. Figure 20 shows a simplified representation of the SPI with the register map and internal state machine.

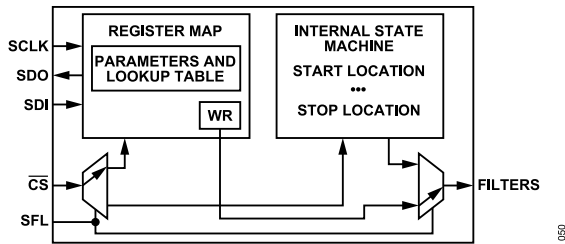

Figure 20. Simplified SPI Diagram

SPI WRITE MODE

SPI write mode has a write grouping (WR) in Register 0x020 through Register 0x022. The grouping consists of the following:

- ▶ f_{CENTER} load value
- ▶ Bandwidth load value
- ▶ Match load value

See the Register Details section more information regarding the write grouping.

SPI STREAMING

In general, there are two types of SPI streaming transactions, Endian register ascending order and descending order. The ADMV8526 supports only the ascending order. To enable SPI streaming with Endian register ascending order, program Register 0x000 to value 0x3C.

For SPI streaming to the write grouping, Register 0x020 to Register 0x022 (recommended), the transaction points to Register 0x020 and streams out 3 bytes of data. The transaction is 40 bits in total (R/W bit + 15 bits address + 24 bits data).

For SPI streaming to the lookup table, Register 0x100 to Register 0x15F (recommended), the transaction points to Register 0x100 and streams out 96 bytes of data. The transaction is 784 bits in total (R/W bit + 15 bits address + 768 bits data).

INTERPOLATION FUNCTIONS

The ADMV8526 has three interpolation functions that allow the user to specify the f_{CENTER} of the filter only using the f_{CENTER} load value, and then the appropriate capacitor codes are determined automatically. To enable these functions, set the INTERPOLATE bit (Register 0x050) high. Figure 21 shows a simplified diagram of the interpolation functions.

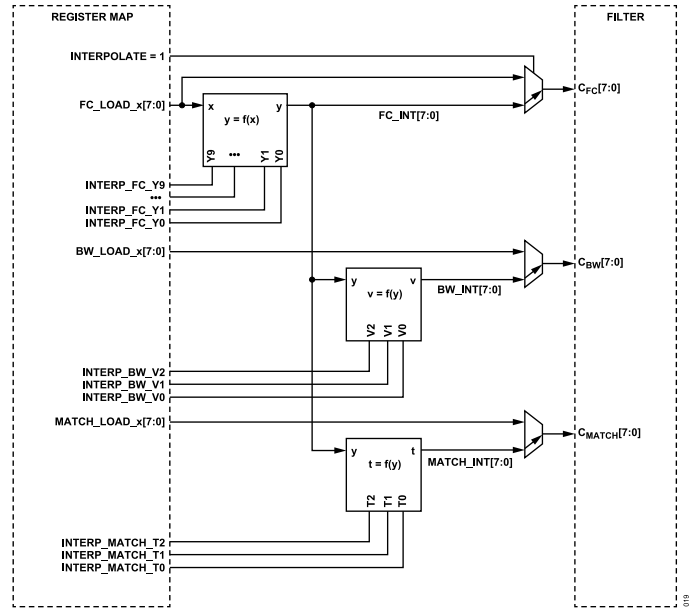

Figure 21. Interpolation Diagram

When the interpolation functions are enabled, the f_{CENTER} load range is 0 to 255, where 0 corresponds to the lowest frequency, and 255 corresponds to the highest frequency. For example, a value of 0 corresponds to approximately 1.25 GHz, and 255 corresponds to approximately 2.6 GHz. The f_{CENTER} load value is used to determine the appropriate capacitor codes based on the on-chip interpolation coefficients.

By default, the recommended interpolation coefficients are set for nominal 9% bandwidth. The interpolation coefficients can be adjusted between $\pm 2\%$ of nominal bandwidth with reasonable insertion loss. Narrower bandwidth down to approximately 5% can also be achieved at the expense of insertion loss.

THEORY OF OPERATION

INTERPOLATION EQUATIONS

The following equations describe the input to the interpolation functions:

$$f_{CMIN} = \min(f_{CENTER}) \quad (1)$$

$$f_{CMAX} = \max(f_{CENTER}) \quad (2)$$

$$f_{CSTEP} \approx \frac{f_{CMAX} - f_{CMIN}}{255} \quad (3)$$

$$x = FC_LOAD_X, \text{ Bits}[7:0] \quad (4)$$

The anticipated f_{CENTER} of the filter is then computed as follows:

$$f_{CENTER} \approx f_{CMIN} + f_{CSTEP} \times x \quad (5)$$

The equations for the interpolation function of $y = f(x)$ that determines the capacitor codes (C_{FC}) are shown in Table 6.

Table 6. Equations for $y = f(x)$

Condition	Logic Shift Form ¹
If ($0 \leq x < 16$)	$y = Y1 + (((16 - x)(Y0 - Y1)) \gg 4)$
If ($16 \leq x < 32$)	$y = Y2 + (((32 - x)(Y1 - Y2)) \gg 4)$
If ($32 \leq x < 64$)	$y = Y3 + (((64 - x)(Y2 - Y3)) \gg 5)$
If ($64 \leq x < 96$)	$y = Y4 + (((96 - x)(Y3 - Y4)) \gg 5)$
If ($96 \leq x < 128$)	$y = Y5 + (((128 - x)(Y4 - Y5)) \gg 5)$
If ($128 \leq x < 160$)	$y = Y6 + (((160 - x)(Y5 - Y6)) \gg 5)$
If ($160 \leq x < 192$)	$y = Y7 + (((192 - x)(Y6 - Y7)) \gg 5)$
If ($192 \leq x < 224$)	$y = Y8 + (((224 - x)(Y7 - Y8)) \gg 5)$
If ($224 \leq x < 255$)	$y = Y9 + (((256 - x)(Y8 - Y9)) \gg 5)$
Else	$y = Y9$

¹ Y0 to Y9 are the f_{CENTER} coefficients.

The equations for the interpolation function of $v = f(y)$ that determines the bandwidth capacitor codes (C_{BW}) are shown in Table 7.

Table 7. Equations for $v = f(y)$

Condition	Logic Shift Form ¹
If ($0 \leq y < 32$)	$v = V0 + ((y \times (V1 - V0)) \gg 5)$
If ($32 \leq y < 255$)	$v = V1 + (((y - 32)(V2 - V1) \times 295) \gg 16)$
Else	$v = V2$

¹ Y0 to Y2 are the bandwidth coefficients.

The equations for the interpolation function of $t = f(Y)$ that determines the match capacitor codes (C_{MATCH}) are shown in Table 8.

Table 8. Equations for $t = f(y)$

Condition	Logic Shift Form ¹
If ($0 \leq y < 32$)	$t = T0 + ((y \times (T1 - T0)) \gg 5)$
If ($32 \leq y < 255$)	$t = T1 + (((y - 32)(T2 - T1) \times 295) \gg 16)$
Else	$t = T2$

¹ T0 to T2 are the match coefficients.

INTERPOLATION TABLES

Solving the interpolation equations for the lower bounds of each condition in the interpolation function of $y = f(x)$ yields what is detailed in Table 9.

Table 9. Equations for Anticipated f_{CENTER} for Each Significant x Value

x	f_{CENTER}	y = f(x)
0	$f_{CENTER} \approx f_{CMIN}$	Y0
16	$f_{CENTER} \approx f_{CMIN} + f_{CSTEP} \times 16$	Y1
32	$f_{CENTER} \approx f_{CMIN} + f_{CSTEP} \times 32$	Y2
64	$f_{CENTER} \approx f_{CMIN} + f_{CSTEP} \times 64$	Y3
96	$f_{CENTER} \approx f_{CMIN} + f_{CSTEP} \times 96$	Y4
128	$f_{CENTER} \approx f_{CMIN} + f_{CSTEP} \times 128$	Y5
160	$f_{CENTER} \approx f_{CMIN} + f_{CSTEP} \times 160$	Y6
192	$f_{CENTER} \approx f_{CMIN} + f_{CSTEP} \times 192$	Y7
224	$f_{CENTER} \approx f_{CMIN} + f_{CSTEP} \times 224$	Y8
255	$f_{CENTER} \approx f_{CMAX}$	Y9

Similarly, solving the equations for the lower bounds of each condition in the interpolation functions of $v = f(y)$ and $t = f(y)$ yields what is detailed in Table 10.

Table 10. Equations for $v = f(y)$ and $t = f(y)$ for Each Significant y Value

y	v = f(y)	t = f(y)
0	V0	T0
32	V1	T1
255	V2	T2

THEORY OF OPERATION

INTERPOLATION PLOTS

To garner a visual representation of the interpolation functions, the interpolation coefficients vs. their input (from the interpolation tables) can be plotted on a scatter plot. Figure 22, Figure 23, and Figure 24 are the interpolation functions of y , v , and t using the interpolation coefficients.

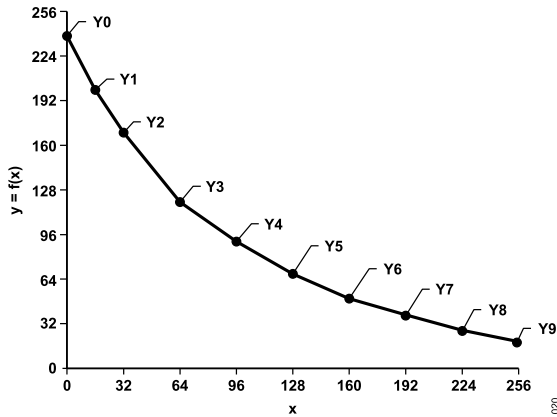

Figure 22. Interpolation Function of $y = f(x)$

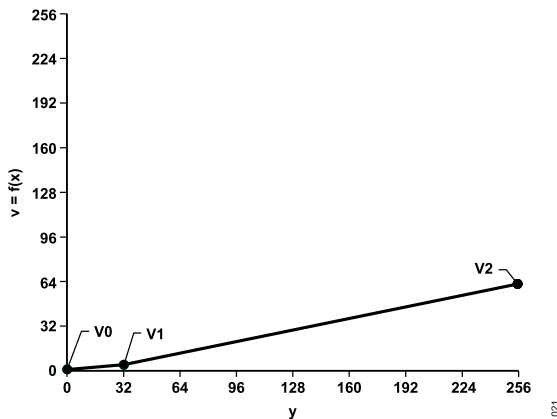

Figure 23. Interpolation Function of $v = f(y)$

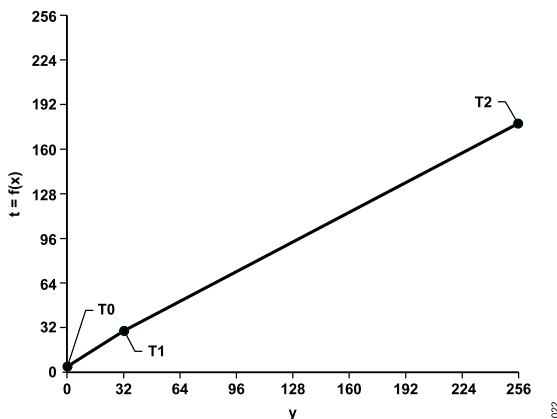

Figure 24. Interpolation Function of $t = f(y)$

INTERPOLATION COEFFICIENT CALIBRATION

Two primary reasons for the need to calibrate the interpolation coefficients include accounting for chip process variation and when a different operating bandwidth is required. The calibration of interpolation coefficients normally follows a four phase process (see Figure 26).

In the first calibration phase, the bandwidth and match coefficients, V1 and T1, are determined for a desired bandwidth. To perform this calibration phase, the f_{CENTER} load value must be set to 32, and then the bandwidth and match load values are adjusted. When satisfied with the results, the V1 and T1 coefficients can be set to the bandwidth and match load values, respectively.

For the second calibration phase, the bandwidth and match coefficients, V2 and T2, are determined for a desired bandwidth. To perform this calibration phase, the f_{CENTER} load value must be set to a high value (180 is recommended), and then the bandwidth and match load values are adjusted. When satisfied with the results, the V2 coefficient can be adjusted so that the computed result of $v = f(y) = f(180)$ is equal to the bandwidth load value. Similarly, the T2 coefficient can be adjusted so that the computed result of $t = f(y) = f(180)$ is equal to the match load value.

For the third calibration phase, the bandwidth and match coefficients, V0 and T0, are determined for a desired bandwidth. To perform this calibration phase, the f_{CENTER} load value must be set to a low value (18 is recommended), and then the bandwidth and match load values are adjusted. When satisfied with the results, the V0 coefficient can be adjusted so that the computed result of $v = f(y) = f(18)$ is equal to the bandwidth load value. Similarly, the T0 coefficient can be adjusted so that the computed result of $t = f(y) = f(18)$ is equal to the match load value.

For the fourth calibration phase, adjustments are made to all of the y coefficients to ensure the operating f_{CENTER} is as close as possible to the anticipated f_{CENTER} . To perform this calibration phase, use Table 9 as a reference for determining the target frequency for each y coefficient. For each x value listed in Table 9, compute the y, v, and t functions, and then set the f_{CENTER} , bandwidth, and match load values, respectively.

FILTER CODE READ BACK

The capacitor codes that are applied to the filter can be read back from the chip using Register 0x060 to Register 0x062. These registers represent the actual state of the capacitors on chip. This information can be useful for debugging purposes or during interpolation coefficient calibration.

THEORY OF OPERATION

SPI FAST LATCH MODE

The ADMV8526 has a 32 state LUT and an internal state machine that is useful for quickly changing filter states in SPI fast latch mode. When the SFL pin is high, SPI fast latch mode enables, and the internal state machine sequences on each rising edge of the \overline{CS} pin.

The LUT has 32 groupings, LUT0 through LUT31, in Register 0x100 through Register 0x15F. Each grouping consists of the same type of parameters as those for SPI write mode.

The functionality of the internal state machine is such that on each rising edge of the \overline{CS} pin, the internal state machine sequences a pointer based on the programmed direction.

The internal state machine has the following parameters:

- ▶ FAST_LATCH_STOP (Register 0x011)
- ▶ FAST_LATCH_START (Register 0x012)
- ▶ FAST_LATCH_DIRECTION (Register 0x013)
- ▶ FAST_LATCH_STATE (Register 0x014)

The FAST_LATCH_STATE is the next LUT grouping that is selected on the next rising edge of the \overline{CS} pin. The FAST_LATCH_STATE is considered the internal pointer location.

When the FAST_LATCH_DIRECTION bit is set to 0, the sequencing direction is incremental. When the FAST_LATCH_DIRECTION bit is set to 1, the sequencing direction is decremental.

The FAST_LATCH_START and FAST_LATCH_STOP bits are used to set the start and stop location, respectively. For incremental direction, the internal state machine sequences from the start location to the stop location and then rolls over to the start location. For the decremental direction, the sequence is from the stop location to the start location and then rolls over to the stop location.

The FAST_LATCH_STATE internal pointer is set to the values stored in FAST_LATCH_START for the incremental direction. For the decremental direction, the internal pointer is set to the values stored in FAST_LATCH_STOP. For this transaction to occur, one rising edge of the \overline{CS} pin is necessary. By nature, this occurs during a SPI transaction in SPI write mode. However, when exiting SPI fast latch mode (SFL pin brought low), be sure to toggle the \overline{CS} pin low then high or perform a SPI transaction so that the FAST_LATCH_STATE refreshes to either the start or stop location accordingly.

CHIP RESET

Two methods are available to reset the ADMV8526 registers to their default power-on state, a hard reset and a soft reset. The hard reset uses the \overline{RST} pin, and the soft reset utilizes Register 0x000.

To perform a hard reset, momentarily bring the \overline{RST} pin low and then high. See [Figure 2](#) for the minimum required duration time for the \overline{RST} pin to be low.

To perform a soft reset, set Register 0x000 to 0x81. This action sets the SOFTRESET and SOFTRESET_ bits high to initiate the reset. The SOFTRESET and SOFTRESET_ bits are self resetting once the reset operation completes.

Regardless of the reset method used, it is recommended to perform the following after the chip resets:

- ▶ Set Register 0x000 to 0x3C to enable the SDO pin and allow SPI streaming with Endian ascending order.
- ▶ Read back all registers on the chip.

APPLICATIONS INFORMATION

INTERPOLATION COEFFICIENTS

For reference, the ADMV8526 interpolation coefficients that were used for device characterization are listed in [Table 11](#). These interpolation coefficients are provided as a good starting point for use in a system. Depending upon the system requirements and allowable process tolerance, some minor adjustments may be needed to the interpolation coefficients. For most applications, the device process tolerance within a particular lot of material allows for one set of interpolation coefficients, such that interpolation coefficient calibration only needs to be performed once per lot. Refer to the [Interpolation Coefficient Calibration](#) section for more information on how to adjust the interpolation coefficients.

Table 11. Interpolation Coefficients

Interpolation Coefficients				
Coefficient	Bit Field	Narrow Bandwidth (7%)	Nominal Bandwidth (9%)	Wide Bandwidth (11%)
Y0	INTERP_FC_Y0	233	239	246
Y1	INTERP_FC_Y1	196	201	207
Y2	INTERP_FC_Y2	164	169	174
Y3	INTERP_FC_Y3	117	120	123
Y4	INTERP_FC_Y4	89	91	93
Y5	INTERP_FC_Y5	67	68	70
Y6	INTERP_FC_Y6	50	51	52
Y7	INTERP_FC_Y7	38	39	39
Y8	INTERP_FC_Y8	28	28	28
Y9	INTERP_FC_Y9	20	20	20
V0	INTERP_BW_V0	4	0	0
V1	INTERP_BW_V1	17	5	0
V2	INTERP_BW_V2	112	64	16
T0	INTERP_MATCH_T0	1	5	0
T1	INTERP_MATCH_T1	21	30	33
T2	INTERP_MATCH_T2	139	178	239

PRINTED CIRCUIT BOARD (PCB) DESIGN GUIDELINES

The PCB used to implement the ADMV8526 can use standard quality dielectric materials between the top metallization layer and internal ground layer, such as the Isola 370HR. Rogers 4003 or the Rogers 4350 do not have to be used. The characteristic impedance of the transmission lines to the RF1 and RF2 pins of the ADMV8526 must be controlled to 50 Ω to ensure optimal RF performance. Connect the GND pins and exposed pads of the ADMV8526 directly to the ground plane of the PCB. Use a sufficient number of via holes to connect the top and bottom ground planes of the PCB.

FLOW CHARTS

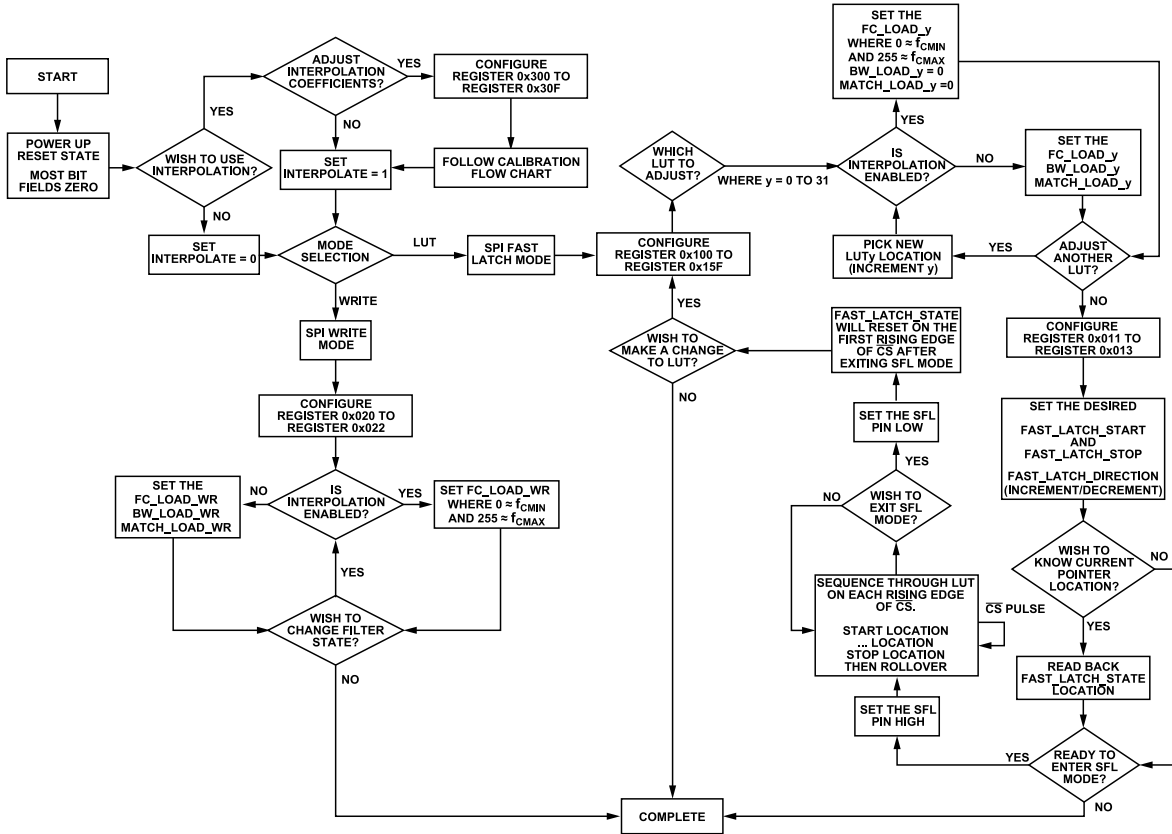

Figure 25. Programming Flow Chart

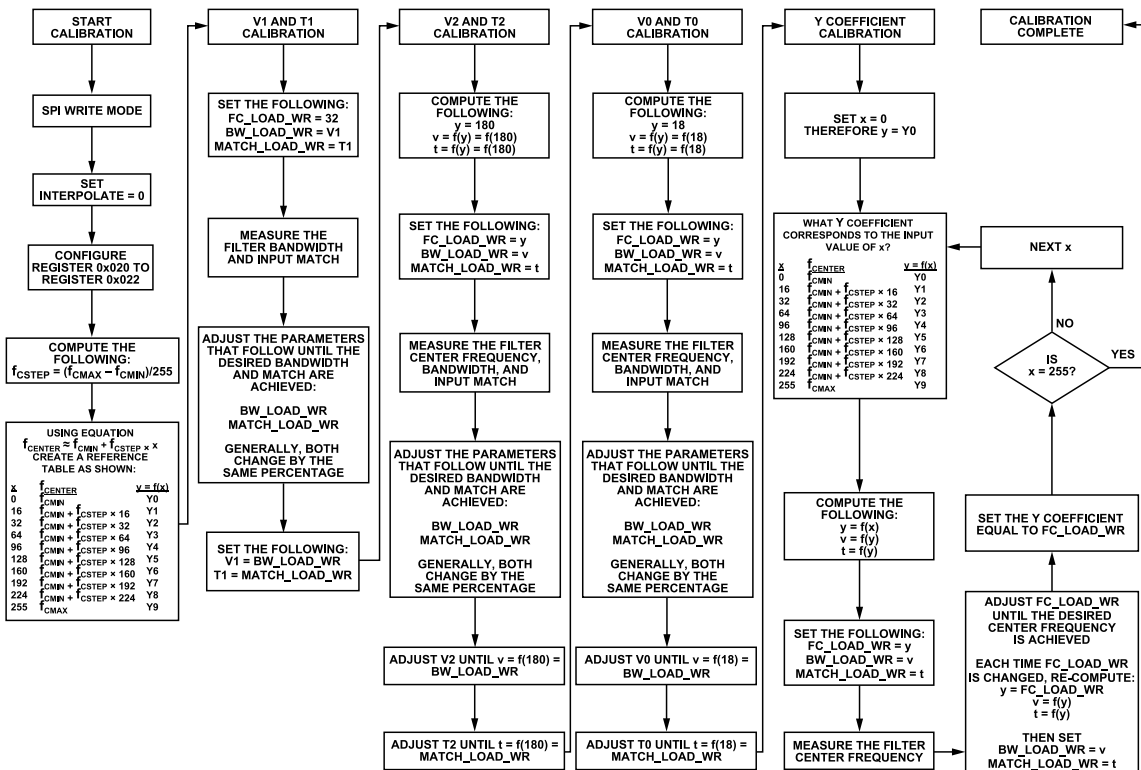

Figure 26. Interpolation Coefficient Calibration Flow Chart

REGISTER SUMMARY

Table 12. ADMV8526 Register Summary

Reg	Name	Bits	Bit 7	Bit 6	Bit 5	Bit 4	Bit 3	Bit 2	Bit 1	Bit 0	Reset	RW	
0x000	ADI_SPI_CONFIG_A	[7:0]	SOFTRESET_	LSB_FIRST_	ENDIAN_	SDOACTIVE_	SDOACTIVE	ENDIAN	LSB_FIRST	SOFTRESET	0x00	R/W	
0x001	ADI_SPI_CONFIG_B	[7:0]	SINGLE_INSTRUCTION	CSB_STALL	CONTROLLER_TARGET_RB	RESERVED			CONTROLLER_TARGET_TRANSFER	0x00	R/W		
0x003	CHIPTYPE	[7:0]	CHIPTYPE								0x01	R	
0x004	PRODUCT_ID_L	[7:0]	PRODUCT_ID_L								0x26	R	
0x005	PRODUCT_ID_H	[7:0]	PRODUCT_ID_H								0x85	R	
0x00C	VARIANT	[7:0]	RESERVED				VARIANT				0x01	R	
0x011	FAST_LATCH_STOP	[7:0]	RESERVED	FAST_LATCH_STOP								0x7F	R/W
0x012	FAST_LATCH_START	[7:0]	RESERVED	FAST_LATCH_START								0x00	R/W
0x013	FAST_LATCH_DIRECTION	[7:0]	RESERVED							FAST_LATCH_DIRECTION	0x00	R/W	
0x014	FAST_LATCH_STATE	[7:0]	RESERVED	FAST_LATCH_STATE								0x00	R
0x020	WR_FC	[7:0]	FC_LOAD_WR								0x00	R/W	
0x021	WR_BW	[7:0]	BW_LOAD_WR								0x00	R/W	
0x022	WR_MATCH	[7:0]	MATCH_LOAD_WR								0x00	R/W	
0x050	FILTER_CONFIG	[7:0]	RESERVED							INTERPOLATE	0x00	R/W	
0x060	FC_READBACK	[7:0]	FC_READBACK								0x00	R	
0x061	BW_READBACK	[7:0]	BW_READBACK								0x00	R	
0x062	MATCH_READBACK	[7:0]	MATCH_READBACK								0x00	R	
0x100	LUT0_FC	[7:0]	FC_LOAD_0								0x00	R/W	
0x101	LUT0_BW	[7:0]	BW_LOAD_0								0x00	R/W	
0x102	LUT0_MATCH	[7:0]	MATCH_LOAD_0								0x00	R/W	
0x103	LUT1_FC	[7:0]	FC_LOAD_1								0x00	R/W	
0x104	LUT1_BW	[7:0]	BW_LOAD_1								0x00	R/W	
0x105	LUT1_MATCH	[7:0]	MATCH_LOAD_1								0x00	R/W	
0x106	LUT2_FC	[7:0]	FC_LOAD_2								0x00	R/W	
0x107	LUT2_BW	[7:0]	BW_LOAD_2								0x00	R/W	
0x108	LUT2_MATCH	[7:0]	MATCH_LOAD_2								0x00	R/W	
0x109	LUT3_FC	[7:0]	FC_LOAD_3								0x00	R/W	
0x10A	LUT3_BW	[7:0]	BW_LOAD_3								0x00	R/W	
0x10B	LUT3_MATCH	[7:0]	MATCH_LOAD_3								0x00	R/W	
0x10C	LUT4_FC	[7:0]	FC_LOAD_4								0x00	R/W	
0x10D	LUT4_BW	[7:0]	BW_LOAD_4								0x00	R/W	
0x10E	LUT4_MATCH	[7:0]	MATCH_LOAD_4								0x00	R/W	
0x10F	LUT5_FC	[7:0]	FC_LOAD_5								0x00	R/W	
0x110	LUT5_BW	[7:0]	BW_LOAD_5								0x00	R/W	
0x111	LUT5_MATCH	[7:0]	MATCH_LOAD_5								0x00	R/W	
0x112	LUT6_FC	[7:0]	FC_LOAD_6								0x00	R/W	
0x113	LUT6_BW	[7:0]	BW_LOAD_6								0x00	R/W	
0x114	LUT6_MATCH	[7:0]	MATCH_LOAD_6								0x00	R/W	
0x115	LUT7_FC	[7:0]	FC_LOAD_7								0x00	R/W	

REGISTER SUMMARY

Table 12. ADMV8526 Register Summary

Reg	Name	Bits	Bit 7	Bit 6	Bit 5	Bit 4	Bit 3	Bit 2	Bit 1	Bit 0	Reset	RW
0x116	LUT7_BW	[7:0]					BW_LOAD_7				0x00	R/W
0x117	LUT7_MATCH	[7:0]					MATCH_LOAD_7				0x00	R/W
0x118	LUT8_FC	[7:0]					FC_LOAD_8				0x00	R/W
0x119	LUT8_BW	[7:0]					BW_LOAD_8				0x00	R/W
0x11A	LUT8_MATCH	[7:0]					MATCH_LOAD_8				0x00	R/W
0x11B	LUT9_FC	[7:0]					FC_LOAD_9				0x00	R/W
0x11C	LUT9_BW	[7:0]					BW_LOAD_9				0x00	R/W
0x11D	LUT9_MATCH	[7:0]					MATCH_LOAD_9				0x00	R/W
0x11E	LUT10_FC	[7:0]					FC_LOAD_10				0x00	R/W
0x11F	LUT10_BW	[7:0]					BW_LOAD_10				0x00	R/W
0x120	LUT10_MATCH	[7:0]					MATCH_LOAD_10				0x00	R/W
0x121	LUT11_FC	[7:0]					FC_LOAD_11				0x00	R/W
0x122	LUT11_BW	[7:0]					BW_LOAD_11				0x00	R/W
0x123	LUT11_MATCH	[7:0]					MATCH_LOAD_11				0x00	R/W
0x124	LUT12_FC	[7:0]					FC_LOAD_12				0x00	R/W
0x125	LUT12_BW	[7:0]					BW_LOAD_12				0x00	R/W
0x126	LUT12_MATCH	[7:0]					MATCH_LOAD_12				0x00	R/W
0x127	LUT13_FC	[7:0]					FC_LOAD_13				0x00	R/W
0x128	LUT13_BW	[7:0]					BW_LOAD_13				0x00	R/W
0x129	LUT13_MATCH	[7:0]					MATCH_LOAD_13				0x00	R/W
0x12A	LUT14_FC	[7:0]					FC_LOAD_14				0x00	R/W
0x12B	LUT14_BW	[7:0]					BW_LOAD_14				0x00	R/W
0x12C	LUT14_MATCH	[7:0]					MATCH_LOAD_14				0x00	R/W
0x12D	LUT15_FC	[7:0]					FC_LOAD_15				0x00	R/W
0x12E	LUT15_BW	[7:0]					BW_LOAD_15				0x00	R/W
0x12F	LUT15_MATCH	[7:0]					MATCH_LOAD_15				0x00	R/W
0x130	LUT16_FC	[7:0]					FC_LOAD_16				0x00	R/W
0x131	LUT16_BW	[7:0]					BW_LOAD_16				0x00	R/W
0x132	LUT16_MATCH	[7:0]					MATCH_LOAD_16				0x00	R/W
0x133	LUT17_FC	[7:0]					FC_LOAD_17				0x00	R/W
0x134	LUT17_BW	[7:0]					BW_LOAD_17				0x00	R/W
0x135	LUT17_MATCH	[7:0]					MATCH_LOAD_17				0x00	R/W
0x136	LUT18_FC	[7:0]					FC_LOAD_18				0x00	R/W
0x137	LUT18_BW	[7:0]					BW_LOAD_18				0x00	R/W
0x138	LUT18_MATCH	[7:0]					MATCH_LOAD_18				0x00	R/W
0x139	LUT19_FC	[7:0]					FC_LOAD_19				0x00	R/W
0x13A	LUT19_BW	[7:0]					BW_LOAD_19				0x00	R/W
0x13B	LUT19_MATCH	[7:0]					MATCH_LOAD_19				0x00	R/W
0x13C	LUT20_FC	[7:0]					FC_LOAD_20				0x00	R/W
0x13D	LUT20_BW	[7:0]					BW_LOAD_20				0x00	R/W
0x13E	LUT20_MATCH	[7:0]					MATCH_LOAD_20				0x00	R/W
0x13F	LUT21_FC	[7:0]					FC_LOAD_21				0x00	R/W
0x140	LUT21_BW	[7:0]					BW_LOAD_21				0x00	R/W
0x141	LUT21_MATCH	[7:0]					MATCH_LOAD_21				0x00	R/W
0x142	LUT22_FC	[7:0]					FC_LOAD_22				0x00	R/W
0x143	LUT22_BW	[7:0]					BW_LOAD_22				0x00	R/W
0x144	LUT22_MATCH	[7:0]					MATCH_LOAD_22				0x00	R/W

REGISTER SUMMARY

Table 12. ADMV8526 Register Summary

Reg	Name	Bits	Bit 7	Bit 6	Bit 5	Bit 4	Bit 3	Bit 2	Bit 1	Bit 0	Reset	RW
0x145	LUT23_FC	[7:0]				FC_LOAD_23					0x00	R/W
0x146	LUT23_BW	[7:0]				BW_LOAD_23					0x00	R/W
0x147	LUT23_MATCH	[7:0]				MATCH_LOAD_23					0x00	R/W
0x148	LUT24_FC	[7:0]				FC_LOAD_24					0x00	R/W
0x149	LUT24_BW	[7:0]				BW_LOAD_24					0x00	R/W
0x14A	LUT24_MATCH	[7:0]				MATCH_LOAD_24					0x00	R/W
0x14B	LUT25_FC	[7:0]				FC_LOAD_25					0x00	R/W
0x14C	LUT25_BW	[7:0]				BW_LOAD_25					0x00	R/W
0x14D	LUT25_MATCH	[7:0]				MATCH_LOAD_25					0x00	R/W
0x14E	LUT26_FC	[7:0]				FC_LOAD_26					0x00	R/W
0x14F	LUT26_BW	[7:0]				BW_LOAD_26					0x00	R/W
0x150	LUT26_MATCH	[7:0]				MATCH_LOAD_26					0x00	R/W
0x151	LUT27_FC	[7:0]				FC_LOAD_27					0x00	R/W
0x152	LUT27_BW	[7:0]				BW_LOAD_27					0x00	R/W
0x153	LUT27_MATCH	[7:0]				MATCH_LOAD_27					0x00	R/W
0x154	LUT28_FC	[7:0]				FC_LOAD_28					0x00	R/W
0x155	LUT28_BW	[7:0]				BW_LOAD_28					0x00	R/W
0x156	LUT28_MATCH	[7:0]				MATCH_LOAD_28					0x00	R/W
0x157	LUT29_FC	[7:0]				FC_LOAD_29					0x00	R/W
0x158	LUT29_BW	[7:0]				BW_LOAD_29					0x00	R/W
0x159	LUT29_MATCH	[7:0]				MATCH_LOAD_29					0x00	R/W
0x15A	LUT30_FC	[7:0]				FC_LOAD_30					0x00	R/W
0x15B	LUT30_BW	[7:0]				BW_LOAD_30					0x00	R/W
0x15C	LUT30_MATCH	[7:0]				MATCH_LOAD_30					0x00	R/W
0x15D	LUT31_FC	[7:0]				FC_LOAD_31					0x00	R/W
0x15E	LUT31_BW	[7:0]				BW_LOAD_31					0x00	R/W
0x15F	LUT31_MATCH	[7:0]				MATCH_LOAD_31					0x00	R/W
0x300	INTERP_FC_Y0	[7:0]				INTERP_FC_Y0					0xE6	R/W
0x301	INTERP_FC_Y1	[7:0]				INTERP_FC_Y1					0xDD	R/W
0x302	INTERP_FC_Y2	[7:0]				INTERP_FC_Y2					0xB9	R/W
0x303	INTERP_FC_Y3	[7:0]				INTERP_FC_Y3					0x83	R/W
0x304	INTERP_FC_Y4	[7:0]				INTERP_FC_Y4					0x63	R/W
0x305	INTERP_FC_Y5	[7:0]				INTERP_FC_Y5					0x4D	R/W
0x306	INTERP_FC_Y6	[7:0]				INTERP_FC_Y6					0x3A	R/W
0x307	INTERP_FC_Y7	[7:0]				INTERP_FC_Y7					0x2C	R/W
0x308	INTERP_FC_Y8	[7:0]				INTERP_FC_Y8					0x21	R/W
0x309	INTERP_FC_Y9	[7:0]				INTERP_FC_Y9					0x19	R/W
0x30A	INTERP_BW_V0	[7:0]				INTERP_BW_V0					0x01	R/W
0x30B	INTERP_BW_V1	[7:0]				INTERP_BW_V1					0x0F	R/W
0x30C	INTERP_BW_V2	[7:0]				INTERP_BW_V2					0x74	R/W
0x30D	INTERP_MATCH_T0	[7:0]				INTERP_MATCH_T0					0x04	R/W
0x30E	INTERP_MATCH_T1	[7:0]				INTERP_MATCH_T1					0x22	R/W
0x30F	INTERP_MATCH_T2	[7:0]				INTERP_MATCH_T2					0xE4	R/W

REGISTER DETAILS

Address: 0x000, Reset: 0x00, Name: ADI_SPI_CONFIG_A

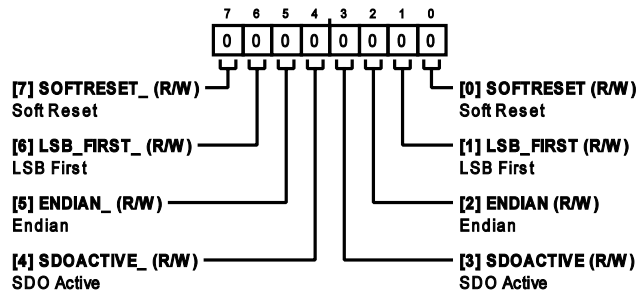

Table 13. Bit Descriptions for ADI_SPI_CONFIG_A

Bits	Bit Name	Description	Reset	Access
7	SOFTRESET_	Soft Reset. 0: reset not asserted. 1: reset asserted.	0x0	R/W
6	LSB_FIRST_	LSB First. 0: MSB first. 1: LSB first.	0x0	R/W
5	ENDIAN_	Endian. 0: Little Endian. 1: Big Endian.	0x0	R/W
4	SDOACTIVE_	SDO Active. 0: SDO inactive. 1: SDO active.	0x0	R/W
3	SDOACTIVE	SDO Active. 0: SDO inactive. 1: SDO active.	0x0	R/W
2	ENDIAN	Endian. 0: Little Endian. 1: Big Endian.	0x0	R/W
1	LSB_FIRST	LSB First. 0: MSB first. 1: LSB first.	0x0	R/W
0	SOFTRESET	Soft Reset. 0: reset not asserted. 1: reset asserted.	0x0	R/W

REGISTER DETAILS

Address: 0x001, Reset: 0x00, Name: ADI_SPI_CONFIG_B

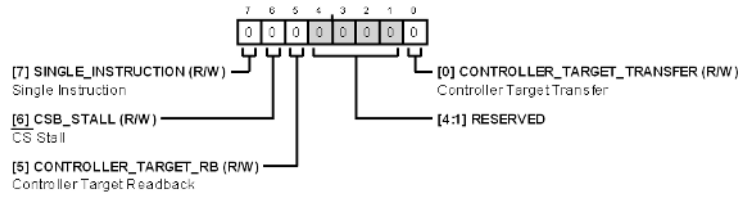

Table 14. Bit Descriptions for ADI_SPI_CONFIG_B

Bits	Bit Name	Description	Reset	Access
7	SINGLE_INSTRUCTION	Single Instruction. 0: enable streaming. 1: disable streaming regardless of CS.	0x0	R/W
6	CSB_STALL	CS Stall.	0x0	R/W
5	CONTROLLER_TARGET_RB	Controller Target Readback.	0x0	R/W
[4:1]	RESERVED	Reserved.	0x0	R
0	CONTROLLER_TARGET_TRANSFER	Controller Target Transfer.	0x0	R/W

Address: 0x003, Reset: 0x01, Name: CHIPTYPE

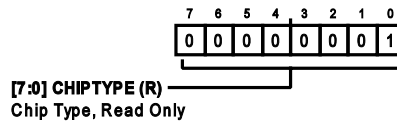

Table 15. Bit Descriptions for CHIPTYPE

Bits	Bit Name	Description	Reset	Access
[7:0]	CHIPTYPE	Chip Type, Read Only.	0x1	R

Address: 0x004, Reset: 0x26, Name: PRODUCT_ID_L

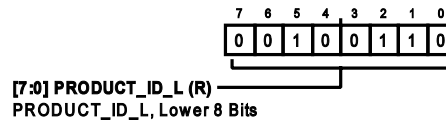

Table 16. Bit Descriptions for PRODUCT_ID_L

Bits	Bit Name	Description	Reset	Access
[7:0]	PRODUCT_ID_L	PRODUCT_ID_L, Lower 8 Bits.	0x26	R

REGISTER DETAILS

Address: 0x005, Reset: 0x85, Name: PRODUCT_ID_H

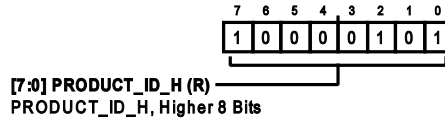

Table 17. Bit Descriptions for PRODUCT_ID_H

Bits	Bit Name	Description	Reset	Access
[7:0]	PRODUCT_ID_H	PRODUCT_ID_H, Higher 8 Bits.	0x85	R

Address: 0x00C, Reset: 0x01, Name: VARIANT

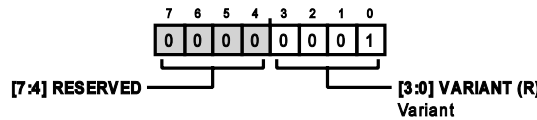

Table 18. Bit Descriptions for VARIANT

Bits	Bit Name	Description	Reset	Access
[7:4]	RESERVED	Reserved.	0x0	R
[3:0]	VARIANT	Variant.	0x1	R

Address: 0x011, Reset: 0x7F, Name: FAST_LATCH_STOP

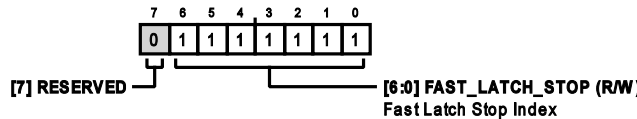

Table 19. Bit Descriptions for FAST_LATCH_STOP

Bits	Bit Name	Description	Reset	Access
7	RESERVED	Reserved.	0x0	R
[6:0]	FAST_LATCH_STOP	Fast Latch Stop Index. These bits set the stop index within the fast latch lookup table.	0x7F	R/W

Address: 0x012, Reset: 0x00, Name: FAST_LATCH_START

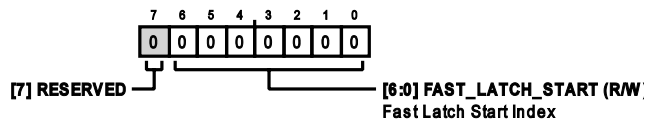

Table 20. Bit Descriptions for FAST_LATCH_START

Bits	Bit Name	Description	Reset	Access
7	RESERVED	Reserved.	0x0	R
[6:0]	FAST_LATCH_START	Fast Latch Start Index. These bits set the start index within the fast latch lookup table.	0x0	R/W

REGISTER DETAILS

Address: 0x013, Reset: 0x00, Name: FAST_LATCH_DIRECTION

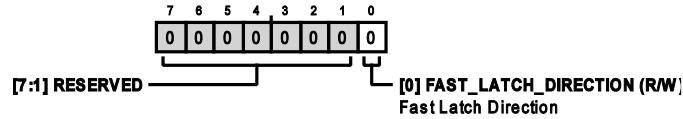

Table 21. Bit Descriptions for FAST_LATCH_DIRECTION

Bits	Bit Name	Description	Reset	Access
[7:1]	RESERVED	Reserved.	0x0	R
0	FAST_LATCH_DIRECTION	Fast Latch Direction. This bit determines which direction to sequence within the fast latch lookup table. When the direction is set to increment, the internal state machine is set to the start index. When the direction is set to decrement, the internal state machine is set to the stop index. 0: increment. 1: decrement.	0x0	R/W

Address: 0x014, Reset: 0x00, Name: FAST_LATCH_STATE

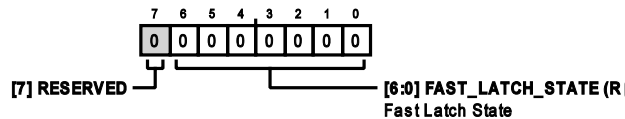

Table 22. Bit Descriptions for FAST_LATCH_STATE

Bits	Bit Name	Description	Reset	Access
7	RESERVED	Reserved.	0x0	R
[6:0]	FAST_LATCH_STATE	Fast Latch State. Reads back the internal state machine index for fast latch lookup table (SFL mode). This index is the next location the internal state machine advances to, on the next CS rising edge. The internal state machine index is set to the start index if the direction is set to increment and is set to the stop index if the direction set to is decrement. Upon changes to the start index, stop index, and direction, the index updates accordingly.	0x0	R

Address: 0x020, Reset: 0x00, Name: WR_FC

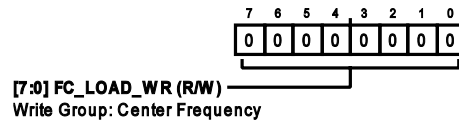

Table 23. Bit Descriptions for WR_FC

Bits	Bit Name	Description	Reset	Access
[7:0]	FC_LOAD_WR	Write Group: Center Frequency.	0x0	R/W

REGISTER DETAILS

Address: 0x021, Reset: 0x00, Name: WR_BW

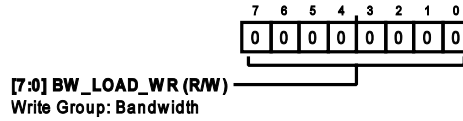

Table 24. Bit Descriptions for WR_BW

Bits	Bit Name	Description	Reset	Access
[7:0]	BW_LOAD_WR	Write Group: Bandwidth.	0x0	R/W

Address: 0x022, Reset: 0x00, Name: WR_MATCH

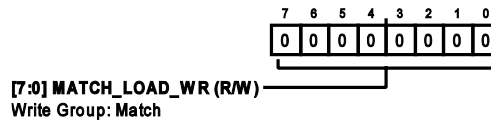

Table 25. Bit Descriptions for WR_MATCH

Bits	Bit Name	Description	Reset	Access
[7:0]	MATCH_LOAD_WR	Write Group: Match.	0x0	R/W

Address: 0x050, Reset: 0x00, Name: FILTER_CONFIG

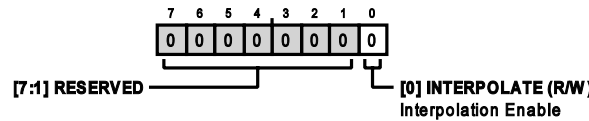

Table 26. Bit Descriptions for FILTER_CONFIG

Bits	Bit Name	Description	Reset	Access
[7:1]	RESERVED	Reserved.	0x0	R
0	INTERPOLATE	Interpolation Enable. When this bit is set to 0, users must program the center frequency, bandwidth, and match. When this bit is set to 1, the capacitors for the center frequency, bandwidth, and match are determined from interpolation.	0x0	R/W

Address: 0x060, Reset: 0x00, Name: FC_READBACK

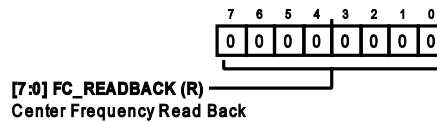

Table 27. Bit Descriptions for FC_READBACK

Bits	Bit Name	Description	Reset	Access
[7:0]	FC_READBACK	Center Frequency Read Back.	0x0	R

REGISTER DETAILS

Address: 0x061, Reset: 0x00, Name: BW_READBACK

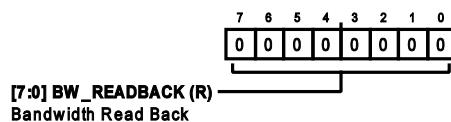

Table 28. Bit Descriptions for BW_READBACK

Bits	Bit Name	Description	Reset	Access
[7:0]	BW_READBACK	Bandwidth Read Back.	0x0	R

Address: 0x062, Reset: 0x00, Name: MATCH_READBACK

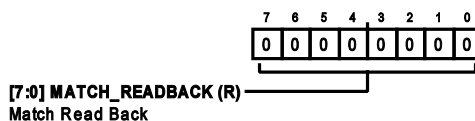

Table 29. Bit Descriptions for MATCH_READBACK

Bits	Bit Name	Description	Reset	Access
[7:0]	MATCH_READBACK	Match Read Back.	0x0	R

Address: 0x100, Reset: 0x00, Name: LUT0_FC

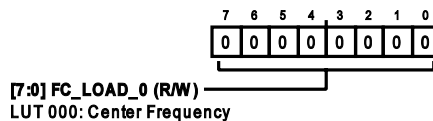

Table 30. Bit Descriptions for LUT0_FC

Bits	Bit Name	Description	Reset	Access
[7:0]	FC_LOAD_0	LUT 000: Center Frequency.	0x0	R/W

Address: 0x101, Reset: 0x00, Name: LUT0_BW

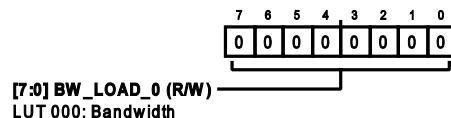

Table 31. Bit Descriptions for LUT0_BW

Bits	Bit Name	Description	Reset	Access
[7:0]	BW_LOAD_0	LUT 000: Bandwidth.	0x0	R/W

REGISTER DETAILS

Address: 0x102, Reset: 0x00, Name: LUT0_MATCH

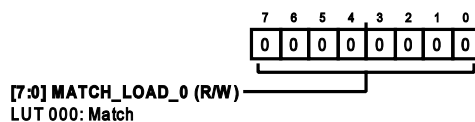

Table 32. Bit Descriptions for LUT0_MATCH

Bits	Bit Name	Description	Reset	Access
[7:0]	MATCH_LOAD_0	LUT 000: Match.	0x0	R/W

Address: 0x103 to 0x15F, Reset: 0x00

The LUT1 to LUT31 bit field functionality (Register 0x103 through Register 0x15F) is similar to LUT0 (Register 0x100 through Register 0x102), see [Table 12](#) for the register address information.

Address: 0x300, Reset: 0xE6, Name: INTERP_FC_Y0

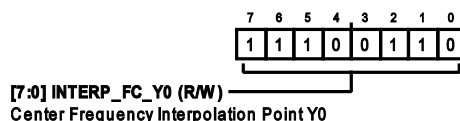

Table 33. Bit Descriptions for INTERP_FC_Y0

Bits	Bit Name	Description	Reset	Access
[7:0]	INTERP_FC_Y0	Center Frequency Interpolation Point Y0.	0xE6	R/W

Address: 0x301, Reset: 0xDD, Name: INTERP_FC_Y1

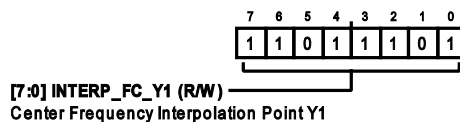

Table 34. Bit Descriptions for INTERP_FC_Y1

Bits	Bit Name	Description	Reset	Access
[7:0]	INTERP_FC_Y1	Center Frequency Interpolation Point Y1.	0xDD	R/W

Address: 0x302, Reset: 0xB9, Name: INTERP_FC_Y2

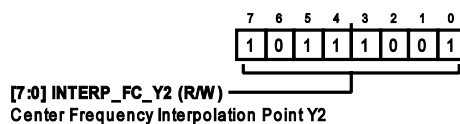

Table 35. Bit Descriptions for INTERP_FC_Y2

Bits	Bit Name	Description	Reset	Access
[7:0]	INTERP_FC_Y2	Center Frequency Interpolation Point Y2.	0xB9	R/W

REGISTER DETAILS

Address: 0x303, Reset: 0x83, Name: INTERP_FC_Y3

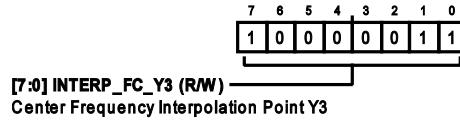

Table 36. Bit Descriptions for INTERP_FC_Y3

Bits	Bit Name	Description	Reset	Access
[7:0]	INTERP_FC_Y3	Center Frequency Interpolation Point Y3.	0x83	R/W

Address: 0x304, Reset: 0x63, Name: INTERP_FC_Y4

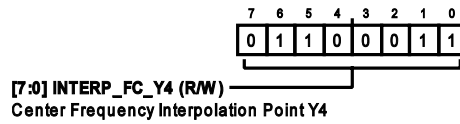

Table 37. Bit Descriptions for INTERP_FC_Y4

Bits	Bit Name	Description	Reset	Access
[7:0]	INTERP_FC_Y4	Center Frequency Interpolation Point Y4.	0x63	R/W

Address: 0x305, Reset: 0x4D, Name: INTERP_FC_Y5

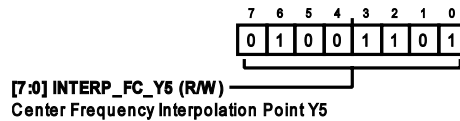

Table 38. Bit Descriptions for INTERP_FC_Y5

Bits	Bit Name	Description	Reset	Access
[7:0]	INTERP_FC_Y5	Center Frequency Interpolation Point Y5.	0x4D	R/W

Address: 0x306, Reset: 0x3A, Name: INTERP_FC_Y6

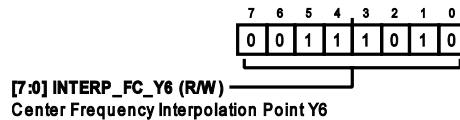

Table 39. Bit Descriptions for INTERP_FC_Y6

Bits	Bit Name	Description	Reset	Access
[7:0]	INTERP_FC_Y6	Center Frequency Interpolation Point Y6.	0x3A	R/W

REGISTER DETAILS

Address: 0x307, Reset: 0x2C, Name: INTERP_FC_Y7

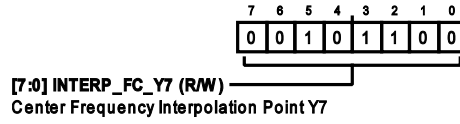

Table 40. Bit Descriptions for INTERP_FC_Y7

Bits	Bit Name	Description	Reset	Access
[7:0]	INTERP_FC_Y7	Center Frequency Interpolation Point Y7.	0x2C	R/W

Address: 0x308, Reset: 0x21, Name: INTERP_FC_Y8

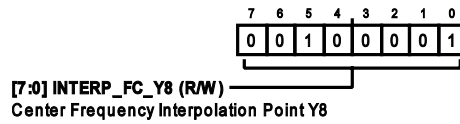

Table 41. Bit Descriptions for INTERP_FC_Y8

Bits	Bit Name	Description	Reset	Access
[7:0]	INTERP_FC_Y8	Center Frequency Interpolation Point Y8.	0x21	R/W

Address: 0x309, Reset: 0x19, Name: INTERP_FC_Y9

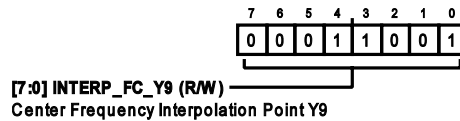

Table 42. Bit Descriptions for INTERP_FC_Y9

Bits	Bit Name	Description	Reset	Access
[7:0]	INTERP_FC_Y9	Center Frequency Interpolation Point Y9.	0x19	R/W

Address: 0x30A, Reset: 0x01, Name: INTERP_BW_V0

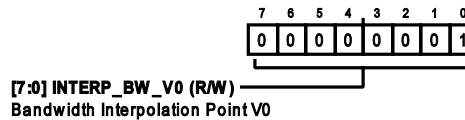

Table 43. Bit Descriptions for INTERP_BW_V0

Bits	Bit Name	Description	Reset	Access
[7:0]	INTERP_BW_V0	Bandwidth Interpolation Point V0.	0x1	R/W

REGISTER DETAILS

Address: 0x30B, Reset: 0x0F, Name: INTERP_BW_V1

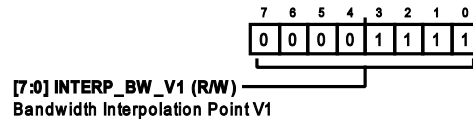

Table 44. Bit Descriptions for INTERP_BW_V1

Bits	Bit Name	Description	Reset	Access
[7:0]	INTERP_BW_V1	Bandwidth Interpolation Point V1.	0xF	R/W

Address: 0x30C, Reset: 0x74, Name: INTERP_BW_V2

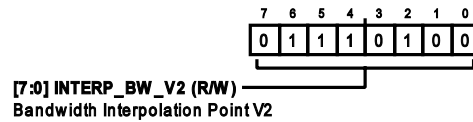

Table 45. Bit Descriptions for INTERP_BW_V2

Bits	Bit Name	Description	Reset	Access
[7:0]	INTERP_BW_V2	Bandwidth Interpolation Point V2.	0x74	R/W

Address: 0x30D, Reset: 0x04, Name: INTERP_MATCH_T0

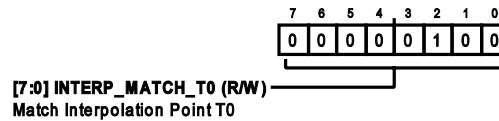

Table 46. Bit Descriptions for INTERP_MATCH_T0

Bits	Bit Name	Description	Reset	Access
[7:0]	INTERP_MATCH_T0	Match Interpolation Point T0.	0x4	R/W

Address: 0x30E, Reset: 0x22, Name: INTERP_MATCH_T1

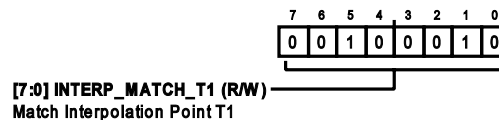

Table 47. Bit Descriptions for INTERP_MATCH_T1

Bits	Bit Name	Description	Reset	Access
[7:0]	INTERP_MATCH_T1	Match Interpolation Point T1.	0x22	R/W

REGISTER DETAILS

Address: 0x30F, Reset: 0xE4, Name: INTERP_MATCH_T2

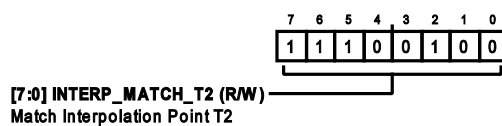

Table 48. Bit Descriptions for INTERP_MATCH_T2

Bits	Bit Name	Description	Reset	Access
[7:0]	INTERP_MATCH_T2	Match Interpolation Point T2.	0xE4	R/W

OUTLINE DIMENSIONS

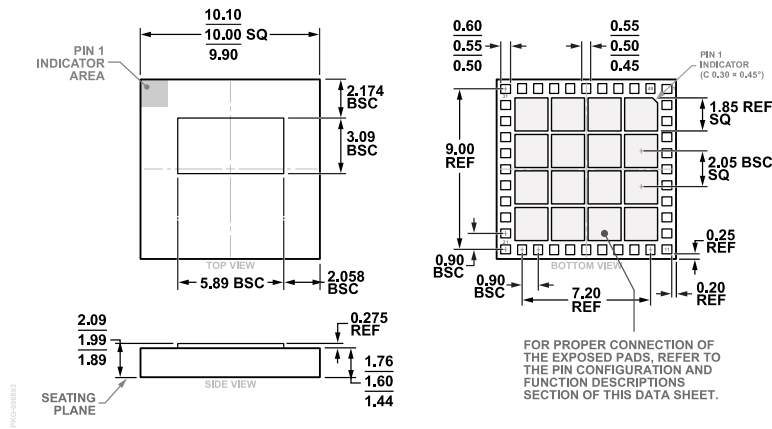

Figure 27. 40-Terminal Land Grid Array Package [LGA]
 10 mm x 10 mm Body and 1.99 mm Package Height
 (CC-40-10)
 Dimensions shown in millimeters

Updated: November 09, 2021

ORDERING GUIDE

Model ¹	Temperature Range	Package Description	Packing Quantity	Package Option
ADMV8526ACCZ	-40°C to +85°C	40-Terminal LGA (10 mm x 10 mm x 1.99 mm)	Reel, 300	CC-40-10
ADMV8526ACCZ-R7	-40°C to +85°C	40-Terminal LGA (10 mm x 10 mm x 1.99 mm)	Reel, 300	CC-40-10

¹ Z = RoHS Compliant Part.

EVALUATION BOARDS

Model ¹	Description
ADMV8526-EVALZ	Evaluation Board

¹ Z = RoHS Compliant Part.