



Electrically held lighting contactor, Contactor amp rating 30A, 0 N.C. / 3 N.O. Poles, 198VAC 50HZ/208VAC 60HZ coil, Combination type, 30A/600V fusible disconnect, Enclosure NEMA type 1, Indoor general purpose use

product brand name	Class LE
design of the product	Electrically held lighting contactor with fusible disconnect switch
special product feature	Compact design; Finger safe control terminals
General technical data	
weight [lb]	39 lb
Height x Width x Depth [in]	24 × 11 × 8 in
touch protection against electrical shock	NA for enclosed products
installation altitude [ft] at height above sea level maximum	6560 ft
ambient temperature [°F]	
• during storage	-67 ... +176 °F
• during operation	32 ... 104 °F
ambient temperature	
• during storage	-55 ... +80 °C
• during operation	0 ... 40 °C
country of origin	USA
Contactors	
size of contactor	30 Amp
number of NO contacts for main contacts	3
number of NC contacts for main contacts	0
operating voltage for main current circuit at AC at 60 Hz maximum	600 V
mechanical service life (operating cycles) of the main contacts typical	10000000
contact rating of the main contacts of lighting contactor	
• with electronic ballast [LED driver] (1 pole per 1 phase) rated value	16A @120V / 8A @277V 1p 1ph
• at tungsten (1 pole per 1 phase) rated value	30A @277V 1p 1ph
• at tungsten (2 poles per 1 phase) rated value	30A @480V 2p 1ph
• at tungsten (3 poles per 3 phases) rated value	30A @480V 3p 3ph
• at ballast (1 pole per 1 phase) rated value	30A @347V 1p 1ph
• at ballast (2 poles per 1 phase) rated value	30A @600V 2p 1ph
• at ballast (3 poles per 3 phases) rated value	30A @600V 3p 3ph
• at resistive load (1 pole per 1 phase) rated value	30A @600V 1p 1ph
• at resistive load (2 poles per 1 phase) rated value	30A @600V 2p 1ph
• at resistive load (3 poles per 3 phases) rated value	30A @600V 3p 3ph
Auxiliary contact	
number of NC contacts at contactor for auxiliary contacts	1
number of NO contacts at contactor for auxiliary contacts	1
number of total auxiliary contacts maximum	4
contact rating of auxiliary contacts of contactor according to UL	A600 / Q600
Coil	

type of voltage of the control supply voltage	AC
control supply voltage	
• at AC at 50 Hz rated value	198 V
• at AC at 60 Hz rated value	208 V
apparent pick-up power of magnet coil at AC	87 VA
apparent holding power of magnet coil at AC	9.4 VA
operating range factor control supply voltage rated value of magnet coil	0.85 ... 1.1
Disconnect Switch	
response value of switch disconnecter	30A / 600V
design of fuse holder	Class R fuse clips
operating class of the fuse link	Class R
Enclosure	
degree of protection NEMA rating of the enclosure	NEMA 1 enclosure
design of the housing	indoors, usable on a general basis
Mounting/wiring	
mounting position	Vertical
fastening method	Surface mounting and installation
type of electrical connection for supply voltage line-side	Box lug
tightening torque [lbf-in] for supply	35 ... 35 lbf-in
type of connectable conductor cross-sections at line-side for AWG cables single or multi-stranded	1x (14 ... 2 AWG)
temperature of the conductor for supply maximum permissible	75 °C
material of the conductor for supply	AL or CU
type of electrical connection for load-side outgoing feeder	Screw-type terminals
tightening torque [lbf-in] for load-side outgoing feeder	18 ... 22 lbf-in
type of connectable conductor cross-sections for AWG cables for load-side outgoing feeder single or multi-stranded	2x (16 ... 12 AWG), 2x (14 ... 8 AWG)
temperature of the conductor for load-side outgoing feeder maximum permissible	75 °C
material of the conductor for load-side outgoing feeder	CU
type of electrical connection of magnet coil	Screw-type terminals
tightening torque [lbf-in] at magnet coil	7 ... 10 lbf-in
type of connectable conductor cross-sections of magnet coil for AWG cables single or multi-stranded	2x (20 ... 16 AWG), 2x (18 ... 14 AWG)
temperature of the conductor at magnet coil maximum permissible	75 °C
material of the conductor at magnet coil	CU
type of electrical connection at contactor for auxiliary contacts	Screw-type terminals
tightening torque [lbf-in] at contactor for auxiliary contacts	7 ... 12 lbf-in
type of connectable conductor cross-sections at contactor for AWG cables for auxiliary contacts single or multi-stranded	2x (20 ... 16 AWG), 2x (18 ... 14 AWG)
temperature of the conductor at contactor for auxiliary contacts maximum permissible	75 °C
material of the conductor at contactor for auxiliary contacts	CU
Short-circuit current rating	
design of the fuse link for short-circuit protection of the main circuit required	100kA@600V (Class J)
certificate of suitability	NEMA ICS 2; UL 508
Further information	
Industrial Controls - Product Overview (Catalogs, Brochures,...)	
www.usa.siemens.com/iccatalog	
Industry Mall (Online ordering system)	
https://mall.industry.siemens.com/mall/en/us/Catalog/product?mlfb=US2:LEFB1C003208B	
Service&Support (Manuals, Certificates, Characteristics, FAQs,...)	
https://support.industry.siemens.com/cs/US/en/ps/US2:LEFB1C003208B	
Image database (product images, 2D dimension drawings, 3D models, device circuit diagrams, EPLAN macros, ...)	
http://www.automation.siemens.com/bilddb/cax_de.aspx?mlfb=US2:LEFB1C003208B&lang=en	
Certificates/approvals	
https://support.industry.siemens.com/cs/US/en/ps/US2:LEFB1C003208B/certificate	



CONDUITS TYP. TOP & BOTTOM

LETTER	CONDUIT SIZE
A	ø12.7 & ø19 CONDUIT
B	ø25.4 & ø31.8 CONDUIT

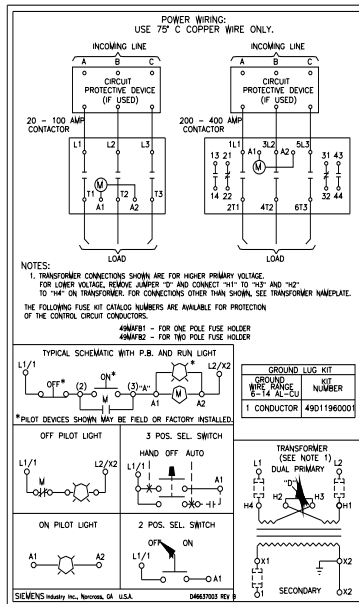

D46637003

last modified:

4/5/2023

