

NO. OF CKTS.	DIM. A	DIM. B
1	(2.44 ± .15) .096 ± .006	—
2	(4.98 ± .15) .196 ± .006	(2.54 ± .10) .100 ± .004
3	(7.52 ± .15) .296 ± .006	(5.08 ± .10) .200 ± .004
4	(10.06 ± .15) .396 ± .006	(7.62 ± .10) .300 ± .004
5	(12.60 ± .18) .496 ± .007	(10.16 ± .13) .400 ± .005
6	(15.14 ± .18) .596 ± .007	(12.70 ± .13) .500 ± .005
7	(17.68 ± .20) .696 ± .008	(15.24 ± .15) .600 ± .006
8	(20.22 ± .20) .796 ± .008	(17.78 ± .15) .700 ± .006
9	(22.76 ± .20) .896 ± .008	(20.32 ± .15) .800 ± .006
10	(25.30 ± .25) .996 ± .010	(22.86 ± .20) .900 ± .008
11	(27.84 ± .25) 1.096 ± .010	(25.40 ± .20) 1.000 ± .008
12	(30.38 ± .25) 1.196 ± .010	(27.94 ± .20) 1.100 ± .008
13	(32.92 ± .25) 1.296 ± .010	(30.48 ± .20) 1.200 ± .008
14	(35.46 ± .25) 1.396 ± .010	(33.02 ± .20) 1.300 ± .008
15	(38.00 ± .28) 1.496 ± .011	(35.56 ± .23) 1.400 ± .009
16	(40.54 ± .28) 1.596 ± .011	(38.10 ± .23) 1.500 ± .009
17	(43.08 ± .28) 1.696 ± .011	(40.64 ± .23) 1.600 ± .009
18	(45.62 ± .28) 1.796 ± .011	(43.18 ± .23) 1.700 ± .009
19	(48.16 ± .28) 1.896 ± .011	(45.72 ± .23) 1.800 ± .009
20	(50.70 ± .30) 1.996 ± .012	(48.26 ± .25) 1.900 ± .010

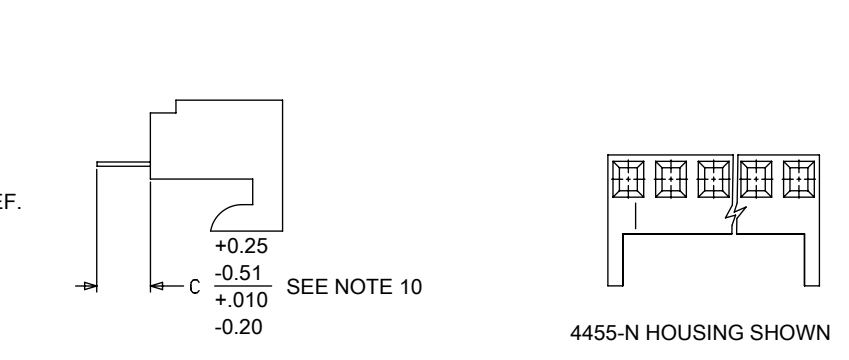

- NOTES:
- MATERIAL: NYLON, UL 94V-0, COLOR: WHITE
 - FINISH:
 - (208) - SELECT GOLD: (0.00038)/.000015 MIN., SELECT TIN: (0.00254)/.000100 MIN. OVERALL NICKEL UNDERPLATE: (0.00127)/.000050 MIN.
 - (228) - SELECT GOLD: (0.00076)/.000030 MIN., SELECT TIN: (0.00254)/.000100 MIN. OVERALL NICKEL UNDERPLATE: (0.00127)/.000050 MIN.
 - (231) - SELECT GOLD: (0.00127)/.000050 MIN., SELECT TIN: (0.00254)/.000100 MIN. OVERALL NICKEL UNDERPLATE: (0.00127)/.000050 MIN.
 - (565) - SELECT GOLD: (0.00051)/.000020 MIN., OVERALL NICKEL: (0.00076)/.000030 MIN. OVERALL GOLD FLASH: (0.00005)/.000002 MIN.
 - (P909) - OVERALL TIN: (0.00254)/.000100 MIN.
 - PARTS CONFORM TO PRODUCT SPECIFICATION PS-10-07.
 - PACKAGING: SEE CHARTS.
 - PARTS MUST CONFORM TO SOLDERABILITY SPEC 152.
 - PARTS ARE STACKABLE END TO END ON (2.54)/.100 CENTERS.
 - TYPICAL PCB THICKNESS: (1.57)/.062
 - PART CONFORMS TO CLASS B REQUIREMENTS OF COSMETIC SPECIFICATION PS-45499-002 EXCEPT PROTRUSIONS. PARTS MAY HAVE MORE THAN 2 GATE MARKS.
 - WHEN MATING ASSEMBLIES THAT USE 4455-BN HOUSINGS TO BREAKAWAY FRICTION LOCK OR POLARIZING HEADERS, THE END BACKWALLS MUST BE REMOVED.
 - DIMENSION C MEASURED WITH TERMINAL PUSHED IN AGAINST THE STOP.

DOCUMENT STATUS	P1	RELEASE DATE	2022/07/29	12:32:02
-----------------	----	--------------	------------	----------

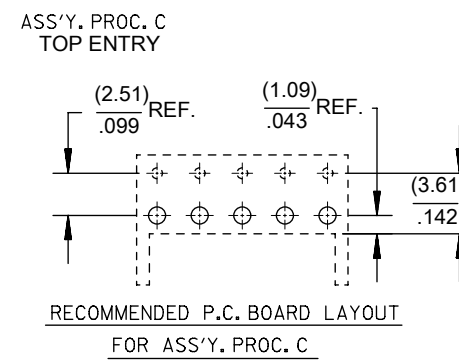
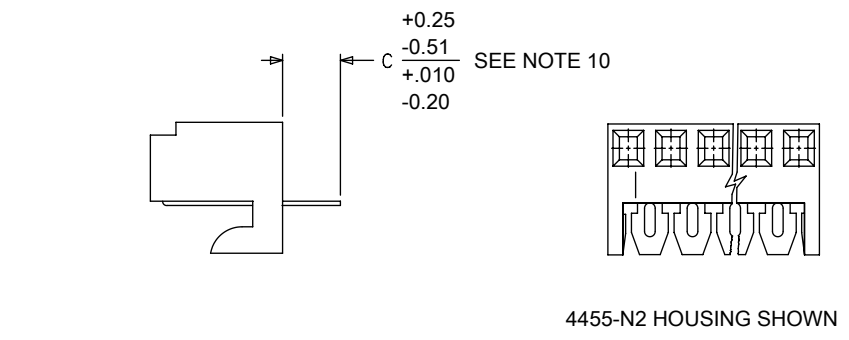
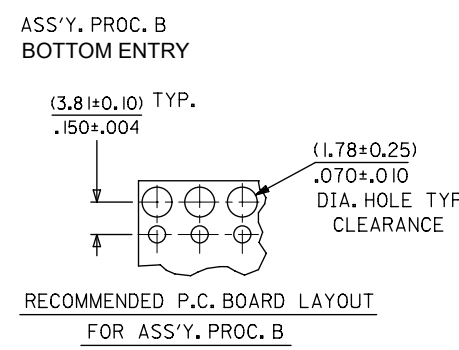
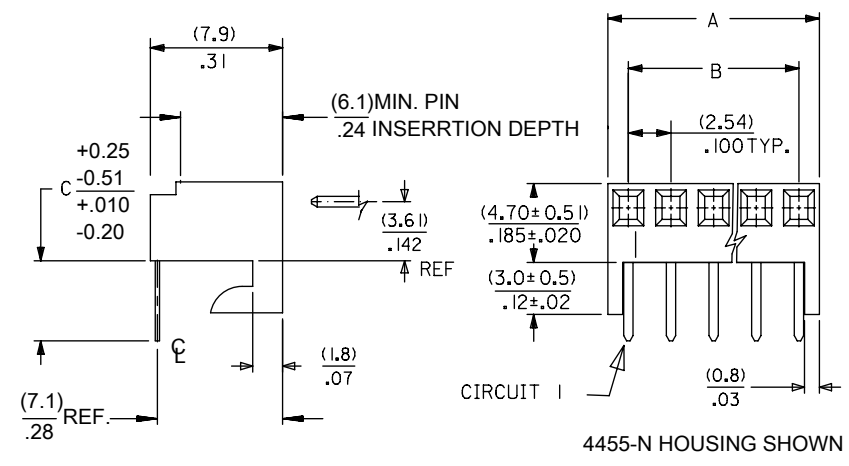
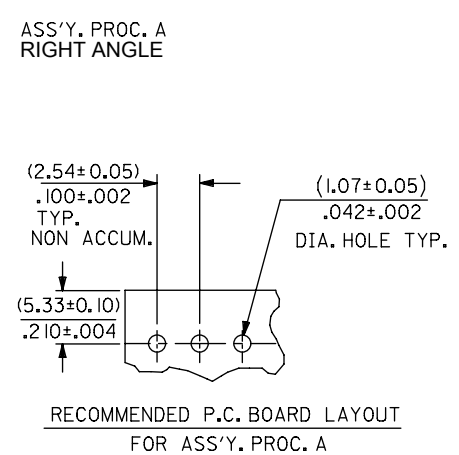
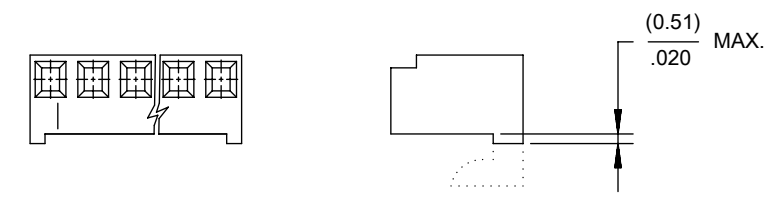
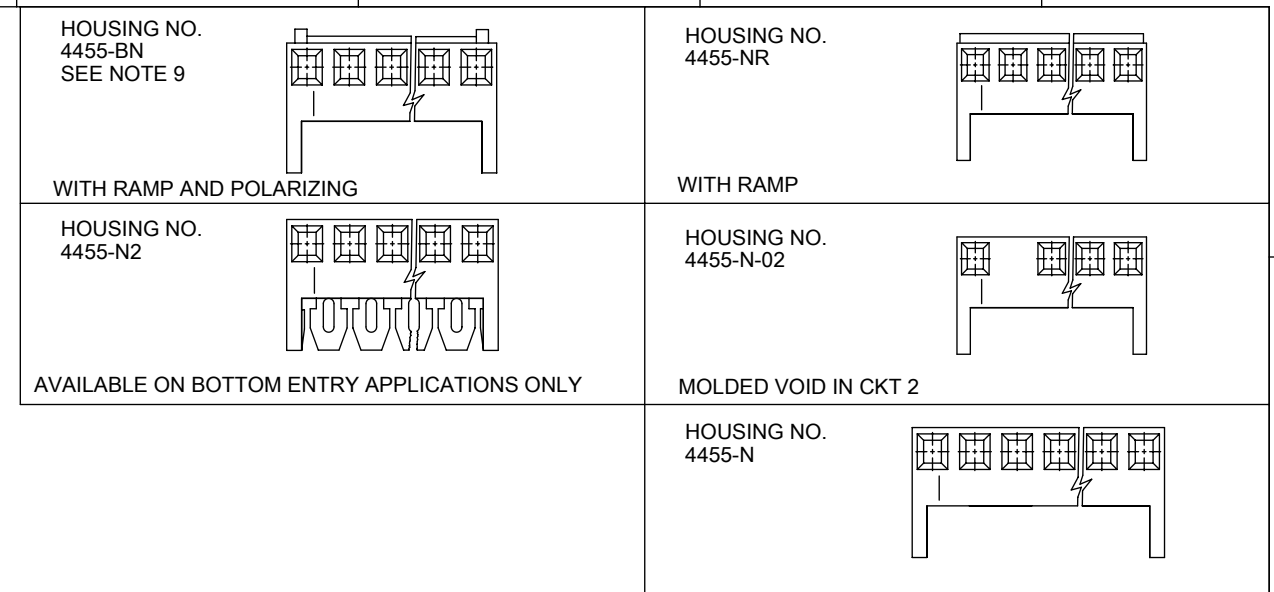

HOOKS CUT OPTION AVAILABLE ON TOP ENTRY, SEE CHART

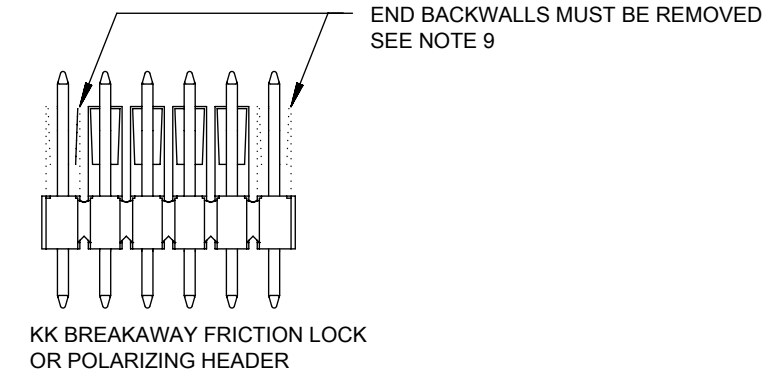

THIS DRAWING CONTAINS INFORMATION THAT IS PROPRIETARY TO MOLEX ELECTRONIC TECHNOLOGIES, LLC AND SHOULD NOT BE USED WITHOUT WRITTEN PERMISSION									
DIMENSION UNITS		SCALE		CURRENT REV DESC: REMOVED OBSOLETE PART NUMBER AS PER PCN#512128.					
MM/IN		1:1		EC NO: 716046 DRWN: SANTHN CHKD: GGA APPR: GGA INITIAL REVISION: DRWN: SAMIEC APPR: LENZ					
GENERAL TOLERANCES (UNLESS SPECIFIED)									
		MM	INCH						
4 PLACES	±		±						
3 PLACES	±		± 0.01						
2 PLACES	±	0.25	± 0.015						
1 PLACE	±	0.36	±						
0 PLACES	±		±						
ANGULAR TOL		± 0.5°		DOCUMENT NUMBER: SDA-4455 DOC TYPE: PSD DOC PART: 001 REVISION: D18					
DRAFT WHERE APPLICABLE MUST REMAIN WITHIN DIMENSIONS		THIRD ANGLE PROJECTION		DRAWING		SERIES		MATERIAL NUMBER	
		B-SIZE		4455		SEE CHART		GENERAL MARKET	
								SHEET NUMBER	
								1 OF 15	

KK 100 PCB ASSY 2-25 CKT 4455 SERIES

A-4455- * * N * * - *

ASSY PROCEDURE
 A=RIGHT ANGLE
 B=BOTTOM ENTRY
 C=TOP ENTRY

HOUSING OPTION

- A=4455-AN
- B=4455-BN
- E=4455-NHH
- G=4455-BN (HOOKS CUT OFF)
- H=4455-N2 (BOTTOM ENTRY ONLY)
- P=4455-NR (HOOKS CUT OFF)
- R=4455-NR
- V=4455-N-02
- W=4455-N-02 (HOOKS CUT OFF)
- Y=4455-N (HOOKS CUT OFF)
- Z=4455-N

NO OF CIRCUITS

TERMINAL TYPE

Code	Number	Material	Form
A	4316-4	Brass	Standard
B	6516-4	Phos Bronze	Standard
C	6516-5C	Phos Bronze	Cat Ear / V
D	4316-3B	Brass	Std / V
F	6516-6C	Phos Bronze	Cat Ear / V
G	4316-3	Brass	Standard
J	6516-3B	Phos Bronze	Std / V
L	6516-3C	Phos Bronze	Cat Ear / V
M	6516-4A	Phos Bronze	Cat Ear
T	4316-4A	Brass	Cat Ear

PLATING

(SEE SHEET 1)

VOID LOCATION
 NUMBER = CIRCUIT VOIDED
 MULTIPLE VOIDS START
 WITH 51
 BLANK = NONE

Ckts	Assy Proc:	RIGHT ANGLE	Assy Proc:	RIGHT ANGLE
		Hooks Cut:	NO	Hooks Cut:
	Housing No:	4455-N	Housing No:	4455-N
	Terminal No:	4316-4(P909)	Terminal No:	4316-4(565)
	Dim C:	3.35 / .132	Dim C:	3.35 / .132
	Plating:	P909	Plating:	565
	Packaging:	PK-44646-001	Packaging:	PK-44646-001
	Voids:	NONE	Voids:	NONE
Material No	Engineer Number	Material No	Engineer Number	
2	22-15-2026	A-4455-AZ02A(P909)	22-16-2021	A-4455-AZ02A(565)
3	22-15-2036	A-4455-AZ03A(P909)	22-16-2031	A-4455-AZ03A(565)
4	22-15-2046	A-4455-AZ04A(P909)	22-16-2041	A-4455-AZ04A(565)
5	22-15-2056	A-4455-AZ05A(P909)	22-16-2051	A-4455-AZ05A(565)
6	22-15-2066	A-4455-AZ06A(P909)	22-16-2061	A-4455-AZ06A(565)
7	22-15-2076	A-4455-AZ07A(P909)	22-16-2071	A-4455-AZ07A(565)
8	22-15-2086	A-4455-AZ08A(P909)	22-16-2081	A-4455-AZ08A(565)
9	22-15-2096	A-4455-AZ09A(P909)	22-16-2091	A-4455-AZ09A(565)
10	22-15-2106	A-4455-AZ10A(P909)	22-16-2101	A-4455-AZ10A(565)
11	22-15-2116	A-4455-AZ11A(P909)	22-16-2111	A-4455-AZ11A(565)
12	22-15-2126	A-4455-AZ12A(P909)	22-16-2121	A-4455-AZ12A(565)
13	22-15-2136	A-4455-AZ13A(P909)	22-16-2131	A-4455-AZ13A(565)
14	22-15-2146	A-4455-AZ14A(P909)	22-16-2141	A-4455-AZ14A(565)
15	22-15-2156	A-4455-AZ15A(P909)	22-16-2151	A-4455-AZ15A(565)
16	22-15-2166	A-4455-AZ16A(P909)	22-16-2161	A-4455-AZ16A(565)
17	22-15-2176	A-4455-AZ17A(P909)	22-16-2171	A-4455-AZ17A(565)
18	22-15-2186	A-4455-AZ18A(P909)	22-16-2181	A-4455-AZ18A(565)
19	22-15-2196	A-4455-AZ19A(P909)	22-16-2191	A-4455-AZ19A(565)
20	22-15-2206	A-4455-AZ20A(P909)	22-16-2201	A-4455-AZ20A(565)
21				
22				
23				
24				
25				

THIS DRAWING CONTAINS INFORMATION THAT IS PROPRIETARY TO MOLEX ELECTRONIC TECHNOLOGIES, LLC AND SHOULD NOT BE USED WITHOUT WRITTEN PERMISSION									
DIMENSION UNITS MM/IN	SCALE 1:1	CURRENT REV DESC: REMOVED OBSOLETE PART NUMBER AS PER PCN#512128.			molex				
GENERAL TOLERANCES (UNLESS SPECIFIED)		EC NO: 716046			KK 100 PCB ASSY 4455 SERIES DWG				
4 PLACES ± ±		DRWN: SANTHN 2022/07/22							
3 PLACES ± ± 0.01		CHKD: GGA 2022/07/29			PRODUCT CUSTOMER DRAWING				
2 PLACES ± 0.25 ± 0.015		APPR: GGA 2022/07/29			DOCUMENT NUMBER DOC TYPE DOC PART REVISION				
1 PLACE ± 0.36 ±		INITIAL REVISION:			SDA-4455		PSD	001	D18
0 PLACES ± ±		DRWN: SAMIEC 1984/05/10							
ANGULAR TOL ± 0.5°		APPR: LENZ 1984/05/10							
DRAFT WHERE APPLICABLE MUST REMAIN WITHIN DIMENSIONS		THIRD ANGLE PROJECTION	DRAWING	SERIES	MATERIAL NUMBER	CUSTOMER		SHEET NUMBER	
		⊕	B-SIZE	4455	SEE CHART	GENERAL MARKET		2 OF 15	

KK 100 PCB ASSY 2-25 CKT 4455 SERIES

STANDARD PRODUCT

Ckts	Assy Proc: RIGHT ANGLE		Assy Proc: BOTTOM ENTRY		Assy Proc: BOTTOM ENTRY		Assy Proc: BOTTOM ENTRY	
	Material No	Engineer Number	Material No	Engineer Number	Material No	Engineer Number	Material No	Engineer Number
2	22-16-2020	A-4455-AZ02A(208)	22-14-2024	A-4455-BH02D(P909)	22-17-2022	A-4455-BH02D(565)	22-17-3022	A-4455-BH02D(208)
3	22-16-2030	A-4455-AZ 03 A(208)	22-14-2034	A-4455-BH 03 D(P909)	22-17-2032	A-4455-BH 03 D(565)	22-17-3032	A-4455-BH 03 D(208)
4	22-16-2040	A-4455-AZ 04 A(208)	22-14-2044	A-4455-BH 04 D(P909)	22-17-2042	A-4455-BH 04 D(565)	22-17-3042	A-4455-BH 04 D(208)
5	22-16-2050	A-4455-AZ 05 A(208)	22-14-2054	A-4455-BH 05 D(P909)	22-17-2052	A-4455-BH 05 D(565)	22-17-3052	A-4455-BH 05 D(208)
6	22-16-2060	A-4455-AZ 06 A(208)	22-14-2064	A-4455-BH 06 D(P909)	22-17-2062	A-4455-BH 06 D(565)	22-17-3062	A-4455-BH 06 D(208)
7	22-16-2070	A-4455-AZ 07 A(208)	22-14-2074	A-4455-BH 07 D(P909)	22-17-2072	A-4455-BH 07 D(565)	22-17-3072	A-4455-BH 07 D(208)
8	22-16-2080	A-4455-AZ 08 A(208)	22-14-2084	A-4455-BH 08 D(P909)	22-17-2082	A-4455-BH 08 D(565)	22-17-3082	A-4455-BH 08 D(208)
9	22-16-2090	A-4455-AZ 09 A(208)	22-14-2094	A-4455-BH 09 D(P909)	22-17-2092	A-4455-BH 09 D(565)	22-17-3092	A-4455-BH 09 D(208)
10	22-16-2100	A-4455-AZ 10 A(208)	22-14-2104	A-4455-BH 10 D(P909)	22-17-2102	A-4455-BH 10 D(565)	22-17-3102	A-4455-BH 10 D(208)
11	22-16-2110	A-4455-AZ 11 A(208)	22-14-2114	A-4455-BH 11 D(P909)	22-17-2112	A-4455-BH 11 D(565)	22-17-3112	A-4455-BH 11 D(208)
12	22-16-2120	A-4455-AZ 12 A(208)	22-14-2124	A-4455-BH 12 D(P909)	22-17-2122	A-4455-BH 12 D(565)	22-17-3122	A-4455-BH 12 D(208)
13	22-16-2130	A-4455-AZ 13 A(208)	22-14-2134	A-4455-BH 13 D(P909)	22-17-2132	A-4455-BH 13 D(565)	22-17-3132	A-4455-BH 13 D(208)
14	22-16-2140	A-4455-AZ 14 A(208)	22-14-2144	A-4455-BH 14 D(P909)	22-17-2142	A-4455-BH 14 D(565)	22-17-3142	A-4455-BH 14 D(208)
15	22-16-2150	A-4455-AZ 15 A(208)	22-14-2154	A-4455-BH 15 D(P909)	22-17-2152	A-4455-BH 15 D(565)	22-17-3152	A-4455-BH 15 D(208)
16	22-16-2160	A-4455-AZ 16 A(208)	22-14-2164	A-4455-BH 16 D(P909)	22-17-2162	A-4455-BH 16 D(565)	22-17-3162	A-4455-BH 16 D(208)
17	22-16-2170	A-4455-AZ 17 A(208)	22-14-2174	A-4455-BH 17 D(P909)	22-17-2172	A-4455-BH 17 D(565)	22-17-3172	A-4455-BH 17 D(208)
18	22-16-2180	A-4455-AZ 18 A(208)	22-14-2184	A-4455-BH 18 D(P909)			22-17-3182	A-4455-BH 18 D(208)
19	22-16-2190	A-4455-AZ 19 A(208)	22-14-2194	A-4455-BH 19 D(P909)			22-17-3192	A-4455-BH 19 D(208)
20	22-16-2200	A-4455-AZ 20 A(208)	22-14-2204	A-4455-BH 20 D(P909)	22-17-2202	A-4455-BH 20 D(565)	22-17-3202	A-4455-BH 20 D(208)
21								
22								
23	22-16-2230	A-4455-AZ 23 A(208)						
24								
25								

THIS DRAWING CONTAINS INFORMATION THAT IS PROPRIETARY TO MOLEX ELECTRONIC TECHNOLOGIES, LLC AND SHOULD NOT BE USED WITHOUT WRITTEN PERMISSION											
DIMENSION UNITS MM/IN	SCALE 1:1	CURRENT REV DESC: REMOVED OBSOLETE PART NUMBER AS PER PCN#512128.					molex				
GENERAL TOLERANCES (UNLESS SPECIFIED)		EC NO: 716046					KK 100 PCB ASSY 4455 SERIES DWG				
4 PLACES ± ±		DRWN: SANTHN 2022/07/22									
3 PLACES ± ± 0.01		CHKD: GGA 2022/07/29					PRODUCT CUSTOMER DRAWING				
2 PLACES ± 0.25 ± 0.015		APPR: GGA 2022/07/29					DOCUMENT NUMBER DOC TYPE DOC PART REVISION				
1 PLACE ± 0.36 ±		INITIAL REVISION:					SDA-4455				
0 PLACES ± ±		DRWN: SAMIEC 1984/05/10					PSD 001 D18				
ANGULAR TOL ± 0.5°		APPR: LENZ 1984/05/10					MATERIAL NUMBER CUSTOMER SHEET NUMBER				
DRAFT WHERE APPLICABLE MUST REMAIN WITHIN DIMENSIONS		THIRD ANGLE PROJECTION	DRAWING	SERIES	MATERIAL NUMBER	CUSTOMER	SEE CHART GENERAL MARKET 3 OF 15				
			B-SIZE	4455							

KK 100 PCB ASSY 2-25 CKT 4455 SERIES

Ckts	Assy Proc: TOP ENTRY		Assy Proc: TOP ENTRY		Assy Proc: TOP ENTRY		Assy Proc: RIGHT ANGLE	
	Material No	Engineer Number	Material No	Engineer Number	Material No	Engineer Number	Material No	Engineer Number
2	22-02-2025	A-4455-CZ02A(P909)	22-18-2023	A-4455-CZ02A(565)	22-18-2021	A-4455-CZ02A(208)	22-15-4025	A-4455-AZ02B(P909)
3	22-02-2035	A-4455-CZ 03A(P909)	22-18-2033	A-4455-CZ 03 A(565)	22-18-2031	A-4455-CZ 03 A(208)	22-15-4035	A-4455-AZ 03B(P909)
4	22-02-2045	A-4455-CZ 04A(P909)	22-18-2043	A-4455-CZ 04 A(565)	22-18-2041	A-4455-CZ 04 A(208)	22-15-4045	A-4455-AZ 04B(P909)
5	22-02-2055	A-4455-CZ 05A(P909)	22-18-2053	A-4455-CZ 05 A(565)	22-18-2051	A-4455-CZ 05 A(208)	22-15-4055	A-4455-AZ 05B(P909)
6	22-02-2065	A-4455-CZ 06A(P909)	22-18-2063	A-4455-CZ 06 A(565)	22-18-2061	A-4455-CZ 06 A(208)	22-15-4065	A-4455-AZ 06B(P909)
7	22-02-2075	A-4455-CZ 07A(P909)	22-18-2073	A-4455-CZ 07 A(565)	22-18-2071	A-4455-CZ 07 A(208)	22-15-4075	A-4455-AZ 07B(P909)
8	22-02-2085	A-4455-CZ 08 A(P909)	22-18-2083	A-4455-CZ 08 A(565)	22-18-2081	A-4455-CZ 08 A(208)	22-15-4085	A-4455-AZ 08B(P909)
9	22-02-2095	A-4455-CZ 09 A(P909)	22-18-2093	A-4455-CZ 09 A(565)	22-18-2091	A-4455-CZ 09 A(208)	22-15-4095	A-4455-AZ 09B(P909)
10	22-02-2105	A-4455-CZ 10 A(P909)	22-18-2103	A-4455-CZ 10 A(565)	22-18-2101	A-4455-CZ 10 A(208)	22-15-4105	A-4455-AZ 10B(P909)
11	22-02-2115	A-4455-CZ 11 A(P909)	22-18-2113	A-4455-CZ 11 A(565)	22-18-2111	A-4455-CZ 11 A(208)	22-15-4115	A-4455-AZ 11B(P909)
12	22-02-2125	A-4455-CZ 12 A(P909)	22-18-2123	A-4455-CZ 12 A(565)	22-18-2121	A-4455-CZ 12 A(208)	22-15-4125	A-4455-AZ 12B(P909)
13	22-02-2135	A-4455-CZ 13 A(P909)	22-18-2133	A-4455-CZ 13 A(565)	22-18-2131	A-4455-CZ 13 A(208)	22-15-4135	A-4455-AZ 13B(P909)
14	22-02-2145	A-4455-CZ 14 A(P909)	22-18-2143	A-4455-CZ 14 A(565)	22-18-2141	A-4455-CZ 14 A(208)	22-15-4145	A-4455-AZ 14B(P909)
15	22-02-2155	A-4455-CZ 15 A(P909)			22-18-2151	A-4455-CZ 15 A(208)	22-15-4155	A-4455-AZ 15B(P909)
16	22-02-2165	A-4455-CZ 16 A(P909)			22-18-2161	A-4455-CZ 16 A(208)	22-15-4165	A-4455-AZ 16B(P909)
17	22-02-2175	A-4455-CZ 17 A(P909)			22-18-2171	A-4455-CZ 17 A(208)	22-15-4175	A-4455-AZ 17B(P909)
18	22-02-2185	A-4455-CZ 18 A(P909)	22-18-2183	A-4455-CZ 18 A(565)	22-18-2181	A-4455-CZ 18 A(208)	22-15-4185	A-4455-AZ 18B(P909)
19	22-02-2195	A-4455-CZ 19 A(P909)			22-18-2191	A-4455-CZ 19 A(208)	22-15-4195	A-4455-AZ 19B(P909)
20	22-02-2205	A-4455-CZ 20 A(P909)	22-18-2203	A-4455-CZ 20 A(565)	22-18-2201	A-4455-CZ 20 A(208)	22-15-4205	A-4455-AZ 20B(P909)
21							22-15-4215	A-4455-AZ 21B(P909)
22							22-15-4225	A-4455-AZ 22B(P909)
23							22-15-4235	A-4455-AZ 23B(P909)
24							22-15-4245	A-4455-AZ 24B(P909)
25							22-15-4255	A-4455-AZ 25B(P909)

THIS DRAWING CONTAINS INFORMATION THAT IS PROPRIETARY TO MOLEX ELECTRONIC TECHNOLOGIES, LLC AND SHOULD NOT BE USED WITHOUT WRITTEN PERMISSION											
DIMENSION UNITS MM/IN		SCALE 1:1		CURRENT REV DESC: REMOVED OBSOLETE PART NUMBER AS PER PCN#512128.				molex			
GENERAL TOLERANCES (UNLESS SPECIFIED)						EC NO: 716046		KK 100 PCB ASSY 4455 SERIES DWG			
4 PLACES ±						DRWN: SANTHN					
3 PLACES ±						CHKD: GGA		PRODUCT CUSTOMER DRAWING			
2 PLACES ± 0.25 ± 0.015						APPR: GGA		DOCUMENT NUMBER			
1 PLACE ± 0.36 ±						INITIAL REVISION:		SDA-4455			
0 PLACES ±						DRWN: SAMIEC		PSD 001 D18			
ANGULAR TOL ± 0.5°						APPR: LENZ		DOC TYPE DOC PART REVISION			
DRAFT WHERE APPLICABLE MUST REMAIN WITHIN DIMENSIONS				THIRD ANGLE PROJECTION		DRAWING		SERIES		SHEET NUMBER	
						B-SIZE		4455		4 OF 15	

KK 100 PCB ASSY 2-25 CKT

4455 SERIES

Ckts	Assy Proc: RIGHT ANGLE		Assy Proc: RIGHT ANGLE		Assy Proc: BOTTOM ENTRY		Assy Proc: BOTTOM ENTRY	
	Material No	Engineer Number	Material No	Engineer Number	Material No	Engineer Number	Material No	Engineer Number
2	22-16-2024	A-4455-AZ02B(565)			22-17-2021	A-4455-BH02J(565)		
3	22-16-2034	A-4455-AZ 03 B(565)			22-17-2031	A-4455-BH 03 J(565)		
4	22-16-2044	A-4455-AZ 04 B(565)			22-17-2041	A-4455-BH 04 J(565)		
5	22-16-2054	A-4455-AZ 05 B(565)			22-17-2051	A-4455-BH 05 J(565)		
6	22-16-2064	A-4455-AZ 06 B(565)			22-17-2061	A-4455-BH 06 J(565)		
7	22-16-2074	A-4455-AZ 07 B(565)			22-17-2071	A-4455-BH 07 J(565)		
8	22-16-2084	A-4455-AZ 08 B(565)			22-17-2081	A-4455-BH 08 J(565)		
9	22-16-2094	A-4455-AZ 09 B(565)			22-17-2091	A-4455-BH 09 J(565)		
10	22-16-2104	A-4455-AZ 10 B(565)			22-17-2101	A-4455-BH 10 J(565)		
11	22-16-2114	A-4455-AZ 11 B(565)			22-17-2111	A-4455-BH 11 J(565)		
12	22-16-2124	A-4455-AZ 12 B(565)			22-17-2121	A-4455-BH 12 J(565)		
13	22-16-2134	A-4455-AZ 13 B(565)			22-17-2131	A-4455-BH 13 J(565)		
14	22-16-2144	A-4455-AZ 14 B(565)			22-17-2141	A-4455-BH 14 J(565)		
15	22-16-2154	A-4455-AZ 15 B(565)			22-17-2151	A-4455-BH 15 J(565)		
16	22-16-2164	A-4455-AZ 16 B(565)			22-17-2161	A-4455-BH 16 J(565)		
17	22-16-2174	A-4455-AZ 17 B(565)			22-17-2171	A-4455-BH 17 J(565)		
18	22-16-2184	A-4455-AZ 18 B(565)			22-17-2181	A-4455-BH 18 J(565)		
19	22-16-2194	A-4455-AZ 19 B(565)			22-17-2191	A-4455-BH 19 J(565)		
20	22-16-2204	A-4455-AZ 20 B(565)			22-17-2201	A-4455-BH 20 J(565)		
21	22-16-2214	A-4455-AZ 21 B(565)			22-17-2211	A-4455-BH 21 J(565)		
22	22-16-2224	A-4455-AZ 22 B(565)			22-17-2221	A-4455-BH 22 J(565)		
23	22-16-2234	A-4455-AZ 23 B(565)			22-17-2231	A-4455-BH 23 J(565)		
24	22-16-2244	A-4455-AZ 24 B(565)			22-17-2241	A-4455-BH 24 J(565)		
25					22-17-2251	A-4455-BH 25 J(565)		

THIS DRAWING CONTAINS INFORMATION THAT IS PROPRIETARY TO MOLEX ELECTRONIC TECHNOLOGIES, LLC AND SHOULD NOT BE USED WITHOUT WRITTEN PERMISSION										
DIMENSION UNITS	SCALE	CURRENT REV DESC: REMOVED OBSOLETE PART NUMBER AS PER PCN#512128.			molex					
MM/IN	1:1									
GENERAL TOLERANCES (UNLESS SPECIFIED)		EC NO: 716046 DRWN: SANTHN 2022/07/22 CHKD: GGA 2022/07/29 APPR: GGA 2022/07/29			PRODUCT CUSTOMER DRAWING					
	MM INCH									
4 PLACES	± 0.25 ± 0.015									
3 PLACES	± 0.25 ± 0.015									
2 PLACES	± 0.25 ± 0.015									
1 PLACE	± 0.36 ± 0.015	INITIAL REVISION:			DOCUMENT NUMBER: SDA-4455 DOC TYPE: PSD DOC PART: 001 REVISION: D18					
0 PLACES	± 0.36 ± 0.015	DRWN: SAMIEC 1984/05/10 APPR: LENZ 1984/05/10								
ANGULAR TOL ± 0.5°		THIRD ANGLE PROJECTION			DRAWING: B-SIZE		SERIES: 4455		MATERIAL NUMBER: SEE CHART	
DRAFT WHERE APPLICABLE MUST REMAIN WITHIN DIMENSIONS		DRAWING: B-SIZE			SERIES: 4455		CUSTOMER: GENERAL MARKET		SHEET NUMBER: 5 OF 15	

KK 100 PCB ASSY 2-25 CKT 4455 SERIES

Ckts	Assy Proc: TOP ENTRY		Assy Proc: TOP ENTRY		Assy Proc: TOP ENTRY		Assy Proc: RIGHT ANGLE	
	Material No	Engineer Number	Material No	Engineer Number	Material No	Engineer Number	Material No	Engineer Number
2			22-18-2022	A-4455-CZ02B(565)				
3			22-18-2032	A-4455-CZ 03 B(565)				
4			22-18-2042	A-4455-CZ 04 B(565)				
5			22-18-2052	A-4455-CZ 05 B(565)				
6			22-18-2062	A-4455-CZ 06 B(565)				
7			22-18-2072	A-4455-CZ 07 B(565)			22-15-2075	A-4455-AA07A(P909)
8			22-18-2082	A-4455-CZ 08 B(565)			22-15-2085	A-4455-AA 08A(P909)
9			22-18-2092	A-4455-CZ 09 B(565)			22-15-2095	A-4455-AA 09A(P909)
10			22-18-2102	A-4455-CZ 10 B(565)			22-15-2105	A-4455-AA 10A(P909)
11			22-18-2112	A-4455-CZ 11 B(565)			22-15-2115	A-4455-AA 11A(P909)
12			22-18-2122	A-4455-CZ 12 B(565)				
13			22-18-2132	A-4455-CZ 13 B(565)			22-15-2135	A-4455-AA 13A(P909)
14			22-18-2142	A-4455-CZ 14 B(565)			22-15-2145	A-4455-AA 14A(P909)
15			22-18-2152	A-4455-CZ 15 B(565)			22-15-2155	A-4455-AA 15A(P909)
16			22-18-2162	A-4455-CZ 16 B(565)			22-15-2165	A-4455-AA 16A(P909)
17			22-18-2172	A-4455-CZ 17 B(565)			22-15-2175	A-4455-AA 17A(P909)
18			22-18-2182	A-4455-CZ 18 B(565)				
19			22-18-2192	A-4455-CZ 19 B(565)			22-15-2195	A-4455-AA 19A(P909)
20			22-18-2202	A-4455-CZ 20 B(565)				
21			22-18-2212	A-4455-CZ 21 B(565)			22-15-2215	A-4455-AA 21A(P909)
22			22-18-2222	A-4455-CZ 22 B(565)			22-15-2225	A-4455-AA 22A(P909)
23			22-18-2232	A-4455-CZ 23 B(565)				
24			22-18-2242	A-4455-CZ 24 B(565)			22-15-2245	A-4455-AA 24A(P909)
25			22-18-2252	A-4455-CZ 25 B(565)			22-15-2255	A-4455-AA 25A(P909)

THIS DRAWING CONTAINS INFORMATION THAT IS PROPRIETARY TO MOLEX ELECTRONIC TECHNOLOGIES, LLC AND SHOULD NOT BE USED WITHOUT WRITTEN PERMISSION											
DIMENSION UNITS MM/IN		SCALE 1:1		CURRENT REV DESC: REMOVED OBSOLETE PART NUMBER AS PER PCN#512128.				molex			
GENERAL TOLERANCES (UNLESS SPECIFIED)						EC NO: 716046		KK 100 PCB ASSY 4455 SERIES DWG PRODUCT CUSTOMER DRAWING			
4 PLACES ±		MM		INCH		DRWN: SANTHN 2022/07/22					
3 PLACES ±		0.25		0.015		CHKD: GGA 2022/07/29					
2 PLACES ±		0.36		±		APPR: GGA 2022/07/29					
1 PLACE ±		0.5°		ANGULAR TOL ±		INITIAL REVISION:		DOCUMENT NUMBER		DOC TYPE DOC PART REVISION	
0 PLACES ±		THIRD ANGLE PROJECTION		DRAWING		SERIES		MATERIAL NUMBER		CUSTOMER	
DRAFT WHERE APPLICABLE MUST REMAIN WITHIN DIMENSIONS		B-SIZE		4455		SEE CHART		GENERAL MARKET		SHEET NUMBER	
2022/07/29 12:32:02		PSD		001		D18		6 OF 15			

KK 100 PCB ASSY 2-25 CKT 4455 SERIES

Ckts	Assy Proc: RIGHT ANGLE		Assy Proc: RIGHT ANGLE		Assy Proc: RIGHT ANGLE		Assy Proc: RIGHT ANGLE	
	Material No	Engineer Number	Material No	Engineer Number	Material No	Engineer Number	Material No	Engineer Number
2					22-15-4024	A-4455-AB02A(P909)		
3					22-15-4034	A-4455-AB 03A(P909)		
4					22-15-4044	A-4455-AB 04A(P909)		
5					22-15-4054	A-4455-AB 05A(P909)		
6			50-34-8518	A-4455-AB 06 A(228)	22-15-4064	A-4455-AB 06A(P909)		
7					22-15-4074	A-4455-AB 07A(P909)		
8					22-15-4084	A-4455-AB 08A(P909)		
9	22-16-2096	A-4455-AA 09 A(208)			22-15-4094	A-4455-AB 09A(P909)		
10							22-15-2102	A-4455-AE 10A(P909)
11					22-15-4114	A-4455-AB 11A(P909)		
12					22-15-4124	A-4455-AB 12A(P909)		
13					22-15-4134	A-4455-AB 13A(P909)		
14					22-15-4144	A-4455-AB 14A(P909)		
15					22-15-4154	A-4455-AB 15A(P909)		
16					22-15-4164	A-4455-AB 16A(P909)		
17					22-15-4174	A-4455-AB 17A(P909)		
18	22-16-2186	A-4455-AA 18 A(208)						
19	22-16-2196	A-4455-AA 19 A(208)			22-15-4194	A-4455-AB 19A(P909)		
20	22-16-2206	A-4455-AA 20 A(208)			22-15-4204	A-4455-AB 20A(P909)		
21	22-16-2216	A-4455-AA 21 A(208)			22-15-4214	A-4455-AB 21A(P909)		
22	22-16-2226	A-4455-AA 22 A(208)			22-15-4224	A-4455-AB 22A(P909)		
23	22-16-2236	A-4455-AA 23 A(208)			22-15-4234	A-4455-AB 23A(P909)		
24					22-15-4244	A-4455-AB 24A(P909)		
25					22-15-4254	A-4455-AB 25A(P909)	22-15-2252	A-4455-AE 25A(P909)

THIS DRAWING CONTAINS INFORMATION THAT IS PROPRIETARY TO MOLEX ELECTRONIC TECHNOLOGIES, LLC AND SHOULD NOT BE USED WITHOUT WRITTEN PERMISSION																													
DIMENSION UNITS: MM/IN SCALE: 1:1		CURRENT REV DESC: REMOVED OBSOLETE PART NUMBER AS PER PCN#512128.			molex																								
GENERAL TOLERANCES (UNLESS SPECIFIED)		EC NO: 716046 DRWN: SANTHN CHKD: GGA APPR: GGA			KK 100 PCB ASSY 4455 SERIES DWG																								
<table border="1" style="width: 100%; border-collapse: collapse;"> <tr> <th></th> <th>MM</th> <th>INCH</th> </tr> <tr> <td>4 PLACES</td> <td>±</td> <td>±</td> </tr> <tr> <td>3 PLACES</td> <td>±</td> <td>± 0.01</td> </tr> <tr> <td>2 PLACES</td> <td>± 0.25</td> <td>± 0.015</td> </tr> <tr> <td>1 PLACE</td> <td>± 0.36</td> <td>±</td> </tr> <tr> <td>0 PLACES</td> <td>±</td> <td>±</td> </tr> </table>			MM	INCH	4 PLACES	±	±	3 PLACES	±	± 0.01	2 PLACES	± 0.25	± 0.015	1 PLACE	± 0.36	±	0 PLACES	±	±	2022/07/22 2022/07/29 2022/07/29			PRODUCT CUSTOMER DRAWING						
	MM	INCH																											
4 PLACES	±	±																											
3 PLACES	±	± 0.01																											
2 PLACES	± 0.25	± 0.015																											
1 PLACE	± 0.36	±																											
0 PLACES	±	±																											
ANGULAR TOL ± 0.5°		INITIAL REVISION: DRWN: SAMIEC APPR: LENZ			1984/05/10 1984/05/10		DOCUMENT NUMBER: SDA-4455		DOC TYPE: PSD DOC PART: 001 REVISION: D18																				
DRAFT WHERE APPLICABLE MUST REMAIN WITHIN DIMENSIONS		THIRD ANGLE PROJECTION		DRAWING: B-SIZE		SERIES: 4455		MATERIAL NUMBER: SEE CHART		CUSTOMER: GENERAL MARKET SHEET NUMBER: 7 OF 15																			

KK 100 PCB ASSY 2-25 CKT 4455 SERIES

Ckts	Assy Proc: RIGHT ANGLE		Assy Proc: RIGHT ANGLE		Assy Proc: RIGHT ANGLE		Assy Proc: RIGHT ANGLE	
	Material No	Engineer Number	Material No	Engineer Number	Material No	Engineer Number	Material No	Engineer Number
2	22-15-4022	A-4455-AR02A(P909)			22-17-5023	A-4455-AZ02B(228)		
3	22-15-4032	A-4455-AR 03 A(P909)			22-17-5033	A-4455-AZ 03 B(228)		
4	22-15-4042	A-4455-AR 04 A(P909)			22-17-5043	A-4455-AZ 04 B(228)		
5	22-15-4052	A-4455-AR 05 A(P909)						
6	22-15-4062	A-4455-AR 06 A(P909)			22-17-5063	A-4455-AZ 06 B(228)		
7	22-15-4072	A-4455-AR 07 A(P909)			22-17-5073	A-4455-AZ 07 B(228)		
8	22-15-4082	A-4455-AR 08 A(P909)			22-17-5083	A-4455-AZ 08 B(228)		
9	22-15-4092	A-4455-AR 09 A(P909)			22-17-5093	A-4455-AZ 09 B(228)		
10	22-15-4102	A-4455-AR 10 A(P909)			22-17-5103	A-4455-AZ 10 B(228)		
11	22-15-4112	A-4455-AR 11 A(P909)			22-17-5113	A-4455-AZ 11 B(228)		
12	22-15-4122	A-4455-AR 12 A(P909)			22-17-5123	A-4455-AZ 12 B(228)		
13	22-15-4132	A-4455-AR 13 A(P909)			22-17-5133	A-4455-AZ 13 B(228)		
14	22-15-4142	A-4455-AR 14 A(P909)			22-17-5143	A-4455-AZ 14 B(228)		
15	22-15-4152	A-4455-AR 15 A(P909)			22-17-5153	A-4455-AZ 15 B(228)		
16	22-15-4162	A-4455-AR 16 A(P909)			22-17-5163	A-4455-AZ 16 B(228)		
17	22-15-4172	A-4455-AR 17 A(P909)			22-17-5173	A-4455-AZ 17 B(228)		
18	22-15-4182	A-4455-AR 18 A(P909)			22-17-5183	A-4455-AZ 18 B(228)		
19	22-15-4192	A-4455-AR 19 A(P909)			22-17-5193	A-4455-AZ 19 B(228)		
20	22-15-4202	A-4455-AR 20 A(P909)	22-17-5201	A-4455-AZ 20 A(228)	22-17-5203	A-4455-AZ 20 B(228)		
21	22-15-4212	A-4455-AR 21 A(P909)			22-17-5213	A-4455-AZ 21 B(228)		
22	22-15-4222	A-4455-AR 22 A(P909)			22-17-5223	A-4455-AZ 22 B(228)		
23	22-15-4232	A-4455-AR 23 A(P909)			22-17-5233	A-4455-AZ 23 B(228)		
24	22-15-4242	A-4455-AR 24 A(P909)			22-17-5243	A-4455-AZ 24 B(228)		
25	22-15-4252	A-4455-AR 25 A(P909)			22-17-5253	A-4455-AZ 25 B(228)		

THIS DRAWING CONTAINS INFORMATION THAT IS PROPRIETARY TO MOLEX ELECTRONIC TECHNOLOGIES, LLC AND SHOULD NOT BE USED WITHOUT WRITTEN PERMISSION											
DIMENSION UNITS MM/IN		SCALE 1:1		CURRENT REV DESC: REMOVED OBSOLETE PART NUMBER AS PER PCN#512128.							
GENERAL TOLERANCES (UNLESS SPECIFIED)						EC NO: 716046 DRWN: SANTHN CHKD: GGA APPR: GGA		2022/07/22 2022/07/29 2022/07/29		KK 100 PCB ASSY 4455 SERIES DWG	
4 PLACES ±		3 PLACES ±		2 PLACES ±		1 PLACE ±		0 PLACES ±		PRODUCT CUSTOMER DRAWING	
± 0.25		± 0.01		± 0.015		± 0.36		± 0.5°		DOCUMENT NUMBER SDA-4455	
ANGULAR TOL ± 0.5°		THIRD ANGLE PROJECTION		DRAWING		SERIES		MATERIAL NUMBER		CUSTOMER	
DRAFT WHERE APPLICABLE MUST REMAIN WITHIN DIMENSIONS				B-SIZE		4455		SEE CHART		GENERAL MARKET	
INITIAL REVISION: DRWN: SAMIEC APPR: LENZ		1984/05/10 1984/05/10		DOC TYPE PSD		DOC PART 001		REVISION D18		SHEET NUMBER 8 OF 15	

KK 100 PCB ASSY 2-25 CKT 4455 SERIES

Ckts	Assy Proc: BOTTOM ENTRY		Assy Proc: BOTTOM ENTRY		Assy Proc: BOTTOM ENTRY		Assy Proc: BOTTOM ENTRY	
	Material No	Engineer Number	Material No	Engineer Number	Material No	Engineer Number	Material No	Engineer Number
2	22-17-2024	A-4455-BH02D(228)					22-17-2027	A-4455-BH02J(228)
3	22-17-2034	A-4455-BH03D(228)					22-17-2037	A-4455-BH03J(228)
4	22-17-2044	A-4455-BH04D(228)					22-17-2047	A-4455-BH04J(228)
5	22-17-2054	A-4455-BH05D(228)			22-17-3056	A-4455-BH05D(228)	22-17-2057	A-4455-BH05J(228)
6	22-17-2064	A-4455-BH06D(228)			22-17-3066	A-4455-BH06D(228)	22-17-2067	A-4455-BH06J(228)
7	22-17-2074	A-4455-BH07D(228)					22-17-2077	A-4455-BH07J(228)
8	22-17-2084	A-4455-BH08D(228)			22-17-3086	A-4455-BH08D(228)	22-17-2087	A-4455-BH08J(228)
9	22-17-2094	A-4455-BH09D(228)					22-17-2097	A-4455-BH09J(228)
10	22-17-2104	A-4455-BH10D(228)					22-17-2107	A-4455-BH10J(228)
11	22-17-2114	A-4455-BH11D(228)					22-17-2117	A-4455-BH11J(228)
12	22-17-2124	A-4455-BH12D(228)					22-17-2127	A-4455-BH12J(228)
13	22-17-2134	A-4455-BH13D(228)					22-17-2137	A-4455-BH13J(228)
14	22-17-2144	A-4455-BH14D(228)	22-17-2140	A-4455-BH 14 D(231)	22-17-3146	A-4455-BH14D(228)	22-17-2147	A-4455-BH14J(228)
15							22-17-2157	A-4455-BH15J(228)
16	22-17-2164	A-4455-BH16D(228)					22-17-2167	A-4455-BH16J(228)
17							22-17-2177	A-4455-BH17J(228)
18	22-17-2184	A-4455-BH18D(228)					22-17-2187	A-4455-BH18J(228)
19	22-17-2194	A-4455-BH19D(228)			22-17-3196	A-4455-BH19D(228)	22-17-2197	A-4455-BH19J(228)
20	22-17-2204	A-4455-BH20D(228)	22-17-2200	A-4455-BH 20 D(231)	22-17-3206	A-4455-BH20D(228)	22-17-2207	A-4455-BH20J(228)
21	22-17-2214	A-4455-BH21D(228)						
22	22-17-2224	A-4455-BH22D(228)						
23	22-17-2234	A-4455-BH23D(228)						
24	22-17-2244	A-4455-BH24D(228)						
25	22-17-2254	A-4455-BH25D(228)	22-17-2250	A-4455-BH 25 D(231)	22-17-3256	A-4455-BH25D(228)		

THIS DRAWING CONTAINS INFORMATION THAT IS PROPRIETARY TO MOLEX ELECTRONIC TECHNOLOGIES, LLC AND SHOULD NOT BE USED WITHOUT WRITTEN PERMISSION										
DIMENSION UNITS MM/IN	SCALE 1:1	CURRENT REV DESC: REMOVED OBSOLETE PART NUMBER AS PER PCN#512128.			molex					
GENERAL TOLERANCES (UNLESS SPECIFIED)		EC NO: 716046			KK 100 PCB ASSY 4455 SERIES DWG					
4 PLACES ±	MM	INCH	DRWN: SANTHN 2022/07/22			PRODUCT CUSTOMER DRAWING				
3 PLACES ±	0.25	0.015	CHKD: GGA 2022/07/29			DOCUMENT NUMBER				
2 PLACES ±	0.25	0.015	APPR: GGA 2022/07/29			SDA-4455		PSD	001	D18
1 PLACE ±	0.36	±	INITIAL REVISION:			DOC TYPE DOC PART REVISION				
0 PLACES ±	±	±	DRWN: SAMIEC 1984/05/10			SERIES		MATERIAL NUMBER	CUSTOMER	SHEET NUMBER
ANGULAR TOL ± 0.5°			APPR: LENZ 1984/05/10			B-SIZE	4455	SEE CHART	GENERAL MARKET	9 OF 15
DRAFT WHERE APPLICABLE MUST REMAIN WITHIN DIMENSIONS		THIRD ANGLE PROJECTION		DRAWING						

KK 100 PCB ASSY 2-25 CKT 4455 SERIES

Ckts	Assy Proc: TOP ENTRY		Assy Proc: TOP ENTRY		Assy Proc: TOP ENTRY		Assy Proc: TOP ENTRY	
		Hooks Cut:	YES	Hooks Cut:	YES	Hooks Cut:	YES	Hooks Cut:
	Housing No:	4455-NR	Housing No:	4455-N	Housing No:	4455-N	Housing No:	4455-BN
	Terminal No:	4316-4(208)	Terminal No:	4316-4(565)	Terminal No:	4316-4(P909)	Terminal No:	4316-4(P909)
	Dim C:	3.35 / .132	Dim C:	3.35 / .132	Dim C:	3.35 / .132	Dim C:	3.35 / .132
	Plating:	208	Plating:	565	Plating:	P909	Plating:	P909
	Packaging:	PK-44646-003	Packaging:	PK-44646-003	Packaging:	PK-44646-003	Packaging:	PK-44646-002
	Voids:	NO	Voids:	NO	Voids:	NO	Voids:	NO
	Material No	Engineer Number	Material No	Engineer Number	Material No	Engineer Number	Material No	Engineer Number
2			22-18-2026	A-4455-CY02A(565)	22-02-7023	A-4455-CY02A(P909)	22-15-4028	A-4455-CB02A(P909)
3			22-18-2036	A-4455-CY 03 A(565)	22-02-7033	A-4455-CY 03A(P909)	22-15-4038	A-4455-CB 03A(P909)
4			22-18-2046	A-4455-CY 04 A(565)	22-02-7043	A-4455-CY 04A(P909)	22-15-4048	A-4455-CB 04A(P909)
5	22-18-2057	A-4455-CP 05 A(208)			22-02-7053	A-4455-CY 05A(P909)	22-15-4058	A-4455-CB 05A(P909)
6			22-18-2066	A-4455-CY 06 A(565)	22-02-7063	A-4455-CY 06A(P909)	22-15-4068	A-4455-CB 06A(P909)
7					22-02-7073	A-4455-CY 07A(P909)	22-15-4078	A-4455-CB 07A(P909)
8					22-02-7083	A-4455-CY 08A(P909)	22-15-4088	A-4455-CB 08A(P909)
9					22-02-7093	A-4455-CY 09A(P909)	22-15-4098	A-4455-CB 09A(P909)
10					22-02-7103	A-4455-CY 10A(P909)	22-15-4108	A-4455-CB 10A(P909)
11					22-02-7113	A-4455-CY 11A(P909)	22-15-4118	A-4455-CB 11A(P909)
12			22-18-2126	A-4455-CY 12 A(565)	22-02-7123	A-4455-CY 12A(P909)	22-15-4128	A-4455-CB 12A(P909)
13					22-02-7133	A-4455-CY 13A(P909)	22-15-4138	A-4455-CB 13A(P909)
14			22-18-2146	A-4455-CY 14 A(565)	22-02-7143	A-4455-CY 14A(P909)	22-15-4148	A-4455-CB 14A(P909)
15			22-18-2156	A-4455-CY 15 A(565)	22-02-7153	A-4455-CY 15A(P909)	22-15-4158	A-4455-CB 15A(P909)
16			22-18-2166	A-4455-CY 16 A(565)	22-02-7163	A-4455-CY 16A(P909)	22-15-4168	A-4455-CB 16A(P909)
17			22-18-2176	A-4455-CY 17 A(565)	22-02-7173	A-4455-CY 17A(P909)	22-15-4178	A-4455-CB 17A(P909)
18			22-18-2186	A-4455-CY 18 A(565)	22-02-7183	A-4455-CY 18A(P909)		
19			22-18-2196	A-4455-CY 19 A(565)	22-02-7193	A-4455-CY 19A(P909)	22-15-4198	A-4455-CB 19A(P909)
20			22-18-2206	A-4455-CY 20 A(565)	22-02-7203	A-4455-CY 20A(P909)	22-15-4208	A-4455-CB 20A(P909)
21			22-18-2216	A-4455-CY 21 A(565)	22-02-7213	A-4455-CY 21A(P909)	22-15-4218	A-4455-CB 21A(P909)
22			22-18-2226	A-4455-CY 22 A(565)	22-02-7223	A-4455-CY 22A(P909)	22-15-4228	A-4455-CB 22A(P909)
23			22-18-2236	A-4455-CY 23 A(565)	22-02-7233	A-4455-CY 23A(P909)	22-15-4238	A-4455-CB 23A(P909)
24			22-18-2246	A-4455-CY 24 A(565)			22-15-4248	A-4455-CB 24A(P909)
25			22-18-2256	A-4455-CY 25 A(565)			22-15-4258	A-4455-CB 25A(P909)

THIS DRAWING CONTAINS INFORMATION THAT IS PROPRIETARY TO MOLEX ELECTRONIC TECHNOLOGIES, LLC AND SHOULD NOT BE USED WITHOUT WRITTEN PERMISSION									
DIMENSION UNITS MM/IN	SCALE 1:1	CURRENT REV DESC: REMOVED OBSOLETE PART NUMBER AS PER PCN#512128.			molex				
GENERAL TOLERANCES (UNLESS SPECIFIED)		EC NO: 716046			KK 100 PCB ASSY 4455 SERIES DWG				
4 PLACES ±		DRWN: SANTHN 2022/07/22							
3 PLACES ±		CHKD: GGA 2022/07/29			PRODUCT CUSTOMER DRAWING				
2 PLACES ± 0.25 ± 0.015		APPR: GGA 2022/07/29			DOCUMENT NUMBER				
1 PLACE ± 0.36 ±		INITIAL REVISION:			DOC TYPE DOC PART REVISION				
0 PLACES ±		DRWN: SAMIEC 1984/05/10			SDA-4455 PSD 001 D18				
ANGULAR TOL ± 0.5°		APPR: LENZ 1984/05/10			SHEET NUMBER				
DRAFT WHERE APPLICABLE MUST REMAIN WITHIN DIMENSIONS		THIRD ANGLE PROJECTION	DRAWING	SERIES	MATERIAL NUMBER	CUSTOMER		SEE CHART	
			B-SIZE	4455	SEE CHART	GENERAL MARKET		10 OF 15	

KK 100 PCB ASSY 2-25 CKT 4455 SERIES

Ckts	Assy Proc: TOP ENTRY		Assy Proc: TOP ENTRY		Assy Proc: TOP ENTRY		Assy Proc: TOP ENTRY	
	Material No	Engineer Number	Material No	Engineer Number	Material No	Engineer Number	Material No	Engineer Number
2	22-65-3020	A-4455-CR02A(P909)			22-18-7023	A-4455-CY02A(208)	22-18-7021	A-4455-CY02B(228)
3	22-65-3030	A-4455-CR 03A(P909)			22-18-7033	A-4455-CY 03 A(208)	22-18-7031 38-00-1478	A-4455-CY 03 B(228)
4	22-65-3040	A-4455-CR 04A(P909)			22-18-7043	A-4455-CY 04 A(208)	22-18-7041	A-4455-CY 04 B(228)
5	22-65-3050	A-4455-CR 05A(P909)			22-18-7053	A-4455-CY 05 A(208)	22-18-7051	A-4455-CY 05 B(228)
6	22-65-3060	A-4455-CR 06A(P909)			22-18-7063	A-4455-CY 06 A(208)	22-18-7061	A-4455-CY 06 B(228)
7	22-65-3070	A-4455-CR 07A(P909)			22-18-7073	A-4455-CY 07 A(208)	22-18-7071	A-4455-CY 07 B(228)
8	22-65-3080	A-4455-CR 08A(P909)			22-18-7083	A-4455-CY 08 A(208)	22-18-7081	A-4455-CY 08 B(228)
9	22-65-3090	A-4455-CR 09A(P909)			22-18-7093	A-4455-CY 09 A(208)	22-18-7091	A-4455-CY 09 B(228)
10	22-65-3100	A-4455-CR 10A(P909)			22-18-7103	A-4455-CY 10 A(208)	22-18-7101	A-4455-CY 10 B(228)
11	22-65-3110	A-4455-CR 11A(P909)			22-18-7113	A-4455-CY 11 A(208)	22-18-7111	A-4455-CY 11 B(228)
12	22-65-3120	A-4455-CR 12A(P909)	22-18-2124	A-4455-CZ 12 B(228)	22-18-7123	A-4455-CY 12 A(208)	22-18-7121	A-4455-CY 12 B(228)
13	22-65-3130	A-4455-CR 13A(P909)			22-18-7133	A-4455-CY 13 A(208)	22-18-7131	A-4455-CY 13 B(228)
14	22-65-3140	A-4455-CR 14A(P909)			22-18-7143	A-4455-CY 14 A(208)	22-18-7141	A-4455-CY 14 B(228)
15	22-65-3150	A-4455-CR 15A(P909)			22-18-7153	A-4455-CY 15 A(208)	22-18-7151	A-4455-CY 15 B(228)
16	22-65-3160	A-4455-CR 16A(P909)	22-18-2164	A-4455-CZ 16 B(228)	22-18-7163	A-4455-CY 16 A(208)	22-18-7161	A-4455-CY 16 B(228)
17	22-65-3170	A-4455-CR 17A(P909)			22-18-7173	A-4455-CY 17 A(208)	22-18-7171	A-4455-CY 17 B(228)
18	22-65-3180	A-4455-CR 18A(P909)			22-18-7183	A-4455-CY 18 A(208)	22-18-7181	A-4455-CY 18 B(228)
19	22-65-3190	A-4455-CR 19A(P909)	22-18-2194	A-4455-CZ 19 B(228)	22-18-7193	A-4455-CY 19 A(208)	22-18-7191	A-4455-CY 19 B(228)
20	22-65-3200	A-4455-CR 20A(P909)			22-18-7203	A-4455-CY 20 A(208)	22-18-7201	A-4455-CY 20 B(228)
21	22-65-3210	A-4455-CR 21A(P909)			22-18-7213	A-4455-CY 21 A(208)	22-18-7211	A-4455-CY 21 B(228)
22	22-65-3220	A-4455-CR 22A(P909)			22-18-7223	A-4455-CY 22 A(208)	22-18-7221	A-4455-CY 22 B(228)
23	22-65-3230	A-4455-CR 23A(P909)			22-18-7233	A-4455-CY 23 A(208)	22-18-7231	A-4455-CY 23 B(228)
24	22-65-3240	A-4455-CR 24A(P909)			22-18-7243	A-4455-CY 24 A(208)		
25	22-65-3250	A-4455-CR 25A(P909)			22-18-7253	A-4455-CY 25 A(208)	22-18-7251	A-4455-CY 25 B(228)

THIS DRAWING CONTAINS INFORMATION THAT IS PROPRIETARY TO MOLEX ELECTRONIC TECHNOLOGIES, LLC AND SHOULD NOT BE USED WITHOUT WRITTEN PERMISSION									
DIMENSION UNITS MM/IN	SCALE 1:1	CURRENT REV DESC: REMOVED OBSOLETE PART NUMBER AS PER PCN#512128.			molex				
GENERAL TOLERANCES (UNLESS SPECIFIED)		EC NO: 716046			KK 100 PCB ASSY 4455 SERIES DWG				
4 PLACES ± 0.25 ± 0.015		DRWN: SANTHN 2022/07/22							
3 PLACES ± 0.25 ± 0.015		CHKD: GGA 2022/07/29			PRODUCT CUSTOMER DRAWING				
2 PLACES ± 0.25 ± 0.015		APPR: GGA 2022/07/29			DOCUMENT NUMBER		DOC TYPE	DOC PART	REVISION
1 PLACE ± 0.36 ±		INITIAL REVISION:			SDA-4455		PSD	001	D18
0 PLACES ±		DRWN: SAMIEC 1984/05/10							
ANGULAR TOL ± 0.5°		APPR: LENZ 1984/05/10			MATERIAL NUMBER		CUSTOMER		SHEET NUMBER
DRAFT WHERE APPLICABLE MUST REMAIN WITHIN DIMENSIONS		THIRD ANGLE PROJECTION		DRAWING	SERIES	SEE CHART		GENERAL MARKET	
				B-SIZE	4455			11 OF 15	

KK 100 PCB ASSY 2-25 CKT 4455 SERIES

Ckts	Assy Proc: RIGHT ANGLE		Assy Proc: BOTTOM ENTRY		Assy Proc: RIGHT ANGLE		Assy Proc: RIGHT ANGLE	
	Material No	Engineer Number	Material No	Engineer Number	Material No	Engineer Number	Material No	Engineer Number
2	38-00-1332	A-4455-AZ02C(P909)	38-00-1392	A-4455-BH02F(P909)			22-14-2079	A-4455-AA07B(P909)
3	38-00-1333	A-4455-AZ03C(P909)	38-00-1393	A-4455-BH03F(P909)			22-14-2089	A-4455-AA 08 B(P909)
4	38-00-1334	A-4455-AZ04C(P909)	38-00-1394	A-4455-BH04F(P909)			22-14-2099	A-4455-AA 09 B(P909)
5	38-00-1335	A-4455-AZ05C(P909)	38-00-1395	A-4455-BH05F(P909)			22-14-2109	A-4455-AA 10 B(P909)
6	38-00-1336	A-4455-AZ06C(P909)	38-00-1396	A-4455-BH06F(P909)			22-14-2119	A-4455-AA 11 B(P909)
7	38-00-1337	A-4455-AZ07C(P909)	38-00-1397	A-4455-BH07F(P909)			22-14-2129	A-4455-AA 12 B(P909)
8	38-00-1338	A-4455-AZ08C(P909)	38-00-1398	A-4455-BH08F(P909)			22-14-2139	A-4455-AA 13 B(P909)
9	38-00-1339	A-4455-AZ09C(P909)	38-00-1399	A-4455-BH09F(P909)			22-14-2149	A-4455-AA 14 B(P909)
10	38-00-1340	A-4455-AZ10C(P909)	38-00-1400	A-4455-BH10F(P909)			22-14-2159	A-4455-AA 15 B(P909)
11	38-00-1341	A-4455-AZ11C(P909)	38-00-1401	A-4455-BH11F(P909)			22-14-2169	A-4455-AA 16 B(P909)
12	38-00-1342	A-4455-AZ12C(P909)	38-00-1402	A-4455-BH12F(P909)			22-14-2179	A-4455-AA 17 B(P909)
13	38-00-1343	A-4455-AZ13C(P909)	38-00-1403	A-4455-BH13F(P909)			22-14-2189	A-4455-AA 18 B(P909)
14	38-00-1344	A-4455-AZ14C(P909)	38-00-1404	A-4455-BH14F(P909)			22-14-2199	A-4455-AA 19 B(P909)
15	38-00-1345	A-4455-AZ15C(P909)	38-00-1405	A-4455-BH15F(P909)			22-14-2209	A-4455-AA 20 B(P909)
16	38-00-1346	A-4455-AZ16C(P909)	38-00-1406	A-4455-BH16F(P909)			22-14-2219	A-4455-AA 21 B(P909)
17	38-00-1347	A-4455-AZ17C(P909)	38-00-1407	A-4455-BH17F(P909)			22-14-2229	A-4455-AA 22 B(P909)
18	38-00-1348	A-4455-AZ18C(P909)	38-00-1408	A-4455-BH18F(P909)			22-14-2239	A-4455-AA 23 B(P909)
19	38-00-1349	A-4455-AZ19C(P909)	38-00-1409	A-4455-BH19F(P909)			22-14-2249	A-4455-AA 24 B(P909)
20	38-00-1350	A-4455-AZ20C(P909)	38-00-1410	A-4455-BH20F(P909)			22-14-2259	A-4455-AA 25 B(P909)
21								
22								
23								
24								
25								

THIS DRAWING CONTAINS INFORMATION THAT IS PROPRIETARY TO MOLEX ELECTRONIC TECHNOLOGIES, LLC AND SHOULD NOT BE USED WITHOUT WRITTEN PERMISSION									
DIMENSION UNITS MM/IN	SCALE 1:1	CURRENT REV DESC: REMOVED OBSOLETE PART NUMBER AS PER PCN#512128.			molex				
GENERAL TOLERANCES (UNLESS SPECIFIED)		EC NO: 716046			KK 100 PCB ASSY 4455 SERIES DWG				
4 PLACES ± 0.25 ± 0.015		DRWN: SANTHN 2022/07/22							
3 PLACES ± 0.25 ± 0.015		CHKD: GGA 2022/07/29			PRODUCT CUSTOMER DRAWING				
2 PLACES ± 0.25 ± 0.015		APPR: GGA 2022/07/29			DOCUMENT NUMBER				
1 PLACE ± 0.36 ± 0.015		INITIAL REVISION:			SDA-4455				
0 PLACES ± 0.36 ± 0.015		DRWN: SAMIEC 1984/05/10			DOC TYPE DOC PART REVISION				
ANGULAR TOL ± 0.5°		APPR: LENZ 1984/05/10			PSD 001 D18				
DRAFT WHERE APPLICABLE MUST REMAIN WITHIN DIMENSIONS		THIRD ANGLE PROJECTION			MATERIAL NUMBER CUSTOMER SHEET NUMBER				
					SEE CHART GENERAL MARKET 12 OF 15				

KK 100 PCB ASSY 2-25 CKT

4455 SERIES

Ckts	Assy Proc: RIGHT ANGLE		Assy Proc: RIGHT ANGLE		Assy Proc: TOP ENTRY		Assy Proc: TOP ENTRY	
	Material No	Engineer Number	Material No	Engineer Number	Material No	Engineer Number	Material No	Engineer Number
2			22-16-3028	A-4455-AB02A(565)	38-00-1422	A-4455-CZ02C(P909)		
3			22-16-3038	A-4455-AB 03 A(565)	38-00-1423	A-4455-CZ03C(P909)		
4			22-16-3048	A-4455-AB 04 A(565)	38-00-1424	A-4455-CZ04C(P909)		
5			22-16-3058	A-4455-AB 05 A(565)	38-00-1425	A-4455-CZ05C(P909)		
6			22-16-3068	A-4455-AB 06 A(565)	38-00-1426	A-4455-CZ06C(P909)	22-02-3068	A-4455-CW06A(P909)-2
7	22-14-3617	A-4455-AA07T(P909)	22-16-3078	A-4455-AB 07 A(565)	38-00-1427	A-4455-CZ07C(P909)	50-29-0004	A-4455-CW07A(P909)-2
8	22-14-3618	A-4455-AA 08 T(P909)	22-16-3088	A-4455-AB 08 A(565)	38-00-1428	A-4455-CZ08C(P909)		
9	22-14-3619	A-4455-AA 09 T(P909)	22-16-3098	A-4455-AB 09 A(565)	38-00-1429	A-4455-CZ09C(P909)		
10	22-14-3711	A-4455-AA 10 T(P909)	22-16-3108	A-4455-AB 10 A(565)	38-00-1430	A-4455-CZ10C(P909)		
11	22-14-3712	A-4455-AA 11 T(P909)	22-16-3118	A-4455-AB 11 A(565)	38-00-1431	A-4455-CZ11C(P909)		
12	22-14-3713	A-4455-AA 12 T(P909)	22-16-3128	A-4455-AB 12 A(565)	38-00-1432	A-4455-CZ12C(P909)		
13	22-14-3714	A-4455-AA 13 T(P909)	22-16-3138	A-4455-AB 13 A(565)	38-00-1433	A-4455-CZ13C(P909)		
14	22-14-3715	A-4455-AA 14 T(P909)	22-16-3148	A-4455-AB 14 A(565)	38-00-1434	A-4455-CZ14C(P909)		
15	22-14-3716	A-4455-AA 15 T(P909)	22-16-3158	A-4455-AB 15 A(565)	38-00-1435	A-4455-CZ15C(P909)		
16	22-14-3717	A-4455-AA 16 T(P909)	22-16-3168	A-4455-AB 16 A(565)	38-00-1436	A-4455-CZ16C(P909)		
17	22-14-3718	A-4455-AA 17 T(P909)	22-16-3178	A-4455-AB 17 A(565)	38-00-1437	A-4455-CZ17C(P909)		
18	22-14-3719	A-4455-AA 18 T(P909)	22-16-3188	A-4455-AB 18 A(565)	38-00-1438	A-4455-CZ18C(P909)		
19	22-14-3811	A-4455-AA 19 T(P909)	22-16-3198	A-4455-AB 19 A(565)	38-00-1439	A-4455-CZ19C(P909)		
20	22-14-3812	A-4455-AA 20 T(P909)	22-16-3208	A-4455-AB 20 A(565)	38-00-1440	A-4455-CZ20C(P909)		
21	22-14-3813	A-4455-AA 21 T(P909)	22-16-3218	A-4455-AB 21 A(565)				
22	22-14-3814	A-4455-AA 22 T(P909)	22-16-3228	A-4455-AB 22 A(565)				
23	22-14-3815	A-4455-AA 23 T(P909)	22-16-3238	A-4455-AB 23 A(565)				
24	22-14-3816	A-4455-AA 24 T(P909)	22-16-3248	A-4455-AB 24 A(565)				
25			22-16-3258	A-4455-AB 25 A(565)				

THIS DRAWING CONTAINS INFORMATION THAT IS PROPRIETARY TO MOLEX ELECTRONIC TECHNOLOGIES, LLC AND SHOULD NOT BE USED WITHOUT WRITTEN PERMISSION															
DIMENSION UNITS MM/IN		SCALE 1:1		CURRENT REV DESC: REMOVED OBSOLETE PART NUMBER AS PER PCN#512128.				molex							
GENERAL TOLERANCES (UNLESS SPECIFIED)				EC NO: 716046 DRWN: SANTHN 2022/07/22 CHKD: GGA 2022/07/29 APPR: GGA 2022/07/29 INITIAL REVISION: DRWN: SAMIEC 1984/05/10 APPR: LENZ 1984/05/10				KK 100 PCB ASSY 4455 SERIES DWG							
								PRODUCT CUSTOMER DRAWING							
								DOCUMENT NUMBER		DOC TYPE		DOC PART		REVISION	
								SDA-4455		PSD		001		D18	
								MATERIAL NUMBER		CUSTOMER		SHEET NUMBER			
DRAFT WHERE APPLICABLE MUST REMAIN WITHIN DIMENSIONS				THIRD ANGLE PROJECTION		DRAWING		SERIES		SEE CHART					
						B-SIZE		4455		GENERAL MARKET					
										13 OF 15					

KK 100 PCB ASSY 2-25 CKT 4455 SERIES

	Assy Proc: TOP ENTRY		Assy Proc: TOP ENTRY		Assy Proc: BOTTOM ENTRY		Assy Proc: BOTTOM ENTRY	
	Hooks Cut:	YES	Hooks Cut:	YES	Hooks Cut:	NO	Hooks Cut:	NO
	Housing No:	4455-N	Housing No:	4455-N	Housing No:	4455-N2	Housing No:	4455-N2
	Terminal No:	6516-4(P909)	Terminal No:	4316-4(P909)	Terminal No:	4316-3B(P909)	Terminal No:	4316-3B(208)
	Dim C:	3.35 / .132	Dim C:	3.35 / .132	Dim C:	.132 / 3.35	Dim C:	.132 / 3.35
	Plating:	P909	Plating:	P909	Plating:	P909	Plating:	208
	Packaging:	PK-44646-003	Packaging:	PK-44646-003	Packaging:	PK-44646-001	Packaging:	PK-44646-001
	Voids:	NO	Voids:	YES IN CKT 2	Voids:	YES IN CKT 10	Voids:	2,3,4,6,7,8,10,11,12
	Material No	Engineer Number	Material No	Engineer Number	Material No	Engineer Number	Material No	Engineer Number
Ckts								
2								
3								
4								
5	50-29-1553	A-4455-CY 05B(P909)						
6	50-29-1554	A-4455-CY 06B(P909)	22-15-5065	A-4455-CY06A(P909)-2				
7								
8								
9								
10								
11					50-36-1881	A-4455-BH11D(P909)-10		
12								
13							26-01-3099	A-4455-BH13D(208)-51
14								
15								
16								
17								
18								
19								
20								
21								
22								
23								
24								
25								

THIS DRAWING CONTAINS INFORMATION THAT IS PROPRIETARY TO MOLEX ELECTRONIC TECHNOLOGIES, LLC AND SHOULD NOT BE USED WITHOUT WRITTEN PERMISSION									
DIMENSION UNITS	SCALE	CURRENT REV DESC: REMOVED OBSOLETE PART NUMBER AS PER PCN#512128.			molex				
MM/IN	1:1								
GENERAL TOLERANCES (UNLESS SPECIFIED)		EC NO: 716046 DRWN: SANTHN 2022/07/22 CHKD: GGA 2022/07/29 APPR: GGA 2022/07/29			KK 100 PCB ASSY 4455 SERIES DWG				
4 PLACES	±								
3 PLACES	±								
2 PLACES	±								
1 PLACE	±								
0 PLACES	±	INITIAL REVISION: DRWN: SAMIEC 1984/05/10 APPR: LENZ 1984/05/10			PRODUCT CUSTOMER DRAWING DOCUMENT NUMBER: SDA-4455 DOC TYPE: PSD DOC PART: 001 REVISION: D18				
ANGULAR TOL	± 0.5°								
DRAFT WHERE APPLICABLE MUST REMAIN WITHIN DIMENSIONS		THIRD ANGLE PROJECTION		DRAWING	SERIES	MATERIAL NUMBER	CUSTOMER		SHEET NUMBER
				B-SIZE	4455	SEE CHART	GENERAL MARKET		14 OF 15

KK 100 PCB ASSY 2-25 CKT 4455 SERIES

Ckts	Material No	Engineer Number	Material No	Engineer Number	Material No	Engineer Number	Material No	Engineer Number
2								
3			46999-0585	A-4455-CG03A(P909)			22-02-2031	A-4455-CY 03A(P909)
4			46999-0583	A-4455-CG04A(P909)				
5								
6			46999-0584	A-4455-CG06A(P909)				
7								
8					46999-0599	A-4455-CP 08A(P909)		
9								
10								
11								
12								
13								
14			46999-0586	A-4455-CG14A(P909)				
15								
16								
17	46999-0582	A-4455-AB17A(P909)-51						
18								
19								
20								
21								
22								
23								
24								
25								

THIS DRAWING CONTAINS INFORMATION THAT IS PROPRIETARY TO MOLEX ELECTRONIC TECHNOLOGIES, LLC AND SHOULD NOT BE USED WITHOUT WRITTEN PERMISSION												
DIMENSION UNITS MM/IN		SCALE 1:1		CURRENT REV DESC: REMOVED OBSOLETE PART NUMBER AS PER PCN#512128.				molex				
GENERAL TOLERANCES (UNLESS SPECIFIED)				EC NO: 716046				KK 100 PCB ASSY 4455 SERIES DWG				
4 PLACES ± 0.25 ± 0.015				DRWN: SANTHN 2022/07/22								
3 PLACES ± 0.25 ± 0.015				CHKD: GGA 2022/07/29				PRODUCT CUSTOMER DRAWING				
2 PLACES ± 0.25 ± 0.015				APPR: GGA 2022/07/29				DOCUMENT NUMBER				
1 PLACE ± 0.36 ± 0.015				INITIAL REVISION:				SDA-4455		PSD	001	D18
0 PLACES ± 0.36 ± 0.015				DRWN: SAMIEC 1984/05/10				MATERIAL NUMBER		CUSTOMER		SHEET NUMBER
ANGULAR TOL ± 0.5°				APPR: LENZ 1984/05/10				SEE CHART		GENERAL MARKET		15 OF 15
DRAFT WHERE APPLICABLE MUST REMAIN WITHIN DIMENSIONS				THIRD ANGLE PROJECTION		DRAWING	SERIES	MATERIAL NUMBER		CUSTOMER		
						B-SIZE	4455					