

DATA SHEET

ADA1200: Linear Amplifier

Applications

- Low-noise amplifier for CATV set-top boxes
- CATV drop amplifier

Features

- 12 dB gain
- 50 to 1000 MHz frequency range
- Noise figure: 2.3 dB
- Single +5 V supply
- Small SOT-89 package
- Materials set consistent with RoHS directives
- Characterized for MER performance

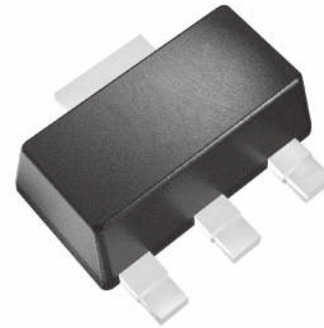

Skyworks Green™ products are compliant with all applicable legislation and are halogen-free. For additional information, refer to *Skyworks Definition of Green™*, document number SQ04-0074.

Description

The ADA1200 is a highly linear amplifier developed to meet the stringent requirements of CATV systems. Offered in a low-cost SOT-89 package, this GaAs MESFET design offers low noise and low distortion over a wide frequency range. The device is ideally suited for applications as a low-noise amplifier in CATV set-top boxes, and as a drop amplifier in CATV distribution systems. The ADA1200 requires a single +5 V supply, and typically consumes 400 mW of power.

A block diagram of the ADA1200 is shown in Figure 1. The device package and pinout are shown in Figure 2. Signal pin assignments and functional pin descriptions are described in Table 1.

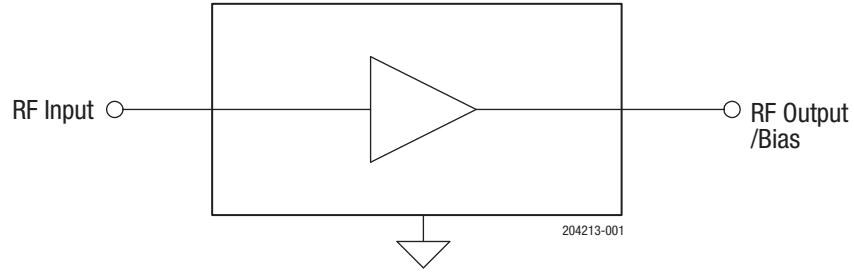

Figure 1. ADA1200 Block Diagram

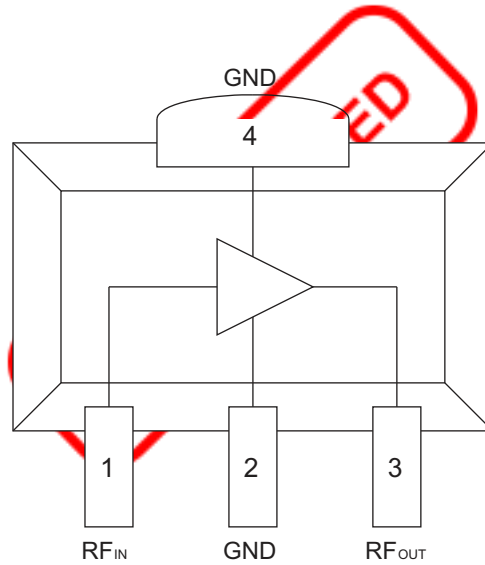

Figure 2. ADA1200 Pinout (Top View)

Table 1. ADA1200 Signal Pin Descriptions

Pin	Name	Description
1	RFIN	RF input
2	GND	Ground
3	RFOUT	RF output/bias
4	GND	Ground

Electrical and Mechanical Specifications

The absolute maximum ratings of the ADA1200 are provided in Table 2. Recommended operating conditions are specified in Table 3.

Electrical specifications are provided in Table 4. Typical performance characteristics are shown in Figures 3 through 16. Evaluation Board S parameters are shown in Table 5.

Table 2. ADA1200 Absolute Maximum Ratings¹

Parameter	Minimum	Maximum	Units
Device voltage (V_{DD})		+9	VDC
RF input power (P_{IN})		+10	dBm
Storage temperature (T_{STG})	-40	+150	°C
Channel temperature		+150	°C

¹ Exposure to maximum rating conditions for extended periods may reduce device reliability. There is no damage to device with only one parameter set at the limit and all other parameters set at or below their nominal value. Exceeding any of the limits listed here may result in permanent damage to the device.

ESD HANDLING: Although this device is designed to be as robust as possible, electrostatic discharge (ESD) can damage this device. This device must be protected at all times from ESD when handling or transporting. Static charges may easily produce potentials of several kilovolts on the human body or equipment, which can discharge without detection. Industry-standard ESD handling precautions should be used at all times.

Table 3. ADA1200 Recommended Operating Conditions¹

Parameter	Min	Typ	Max	Units
RF input/output frequency	50		1000	MHz
Supply voltage (V_{DD})		+5		VDC
Case temperature (T_c)	-40		+100	°C

¹ The device may be operated safely over these conditions; however, parametric performance is guaranteed only over the conditions defined in the electrical specifications.

Table 4. ADA1200 General RF Specifications
(T_A = +25 °C, V_{DD} = +5 VDC, f = 50 to 860 MHz, 75 Ω System, Refer to Figure 17)

Parameter	Min	Typ	Max	Units
Gain	10.5	12	13.5	dB
Noise figure		2.3	3.5	dB
CSO ¹		-61	-55	dBc
CTB ¹		-75	-64	dBc
XMOD ¹		-73		dBc
OIP2 ²	+52			dBm
3-tone OIP3 ³	+32			dBm
P1dB		+66		dBmV
Input return loss		-25	-16	dB
Output return loss		-25	-16	dB
Thermal resistance			50	°C/W
Supply current		80	100	mA
RF output power per channel, MER = 40 dB, 64 QAM, 256 QAM:				
Single channel		60		dBmV/ch
Dual channel		56		dBmV/ch
Triple channel		54		dBmV/ch
Quad channel		53		dBmV/ch

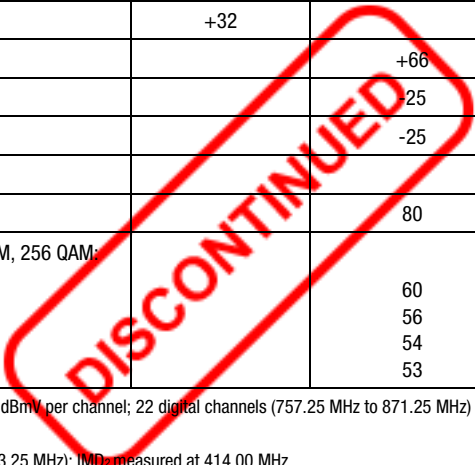

¹ 132 total channels, flat input; 110 analog channels @ +15 dBmV per channel; 22 digital channels (757.25 MHz to 871.25 MHz) @ 6 dB below analog channels; Standard NTSC channel plan (55.25 MHz to 871.25 MHz)

² Two tones, -10 dBm per tone at input (439.25 MHz and 853.25 MHz); IMD₂ measured at 414.00 MHz.

³ Three tones, -10 dBm per tone at input (67.25, 439.25 MHz, 853.25 MHz); IMD₃ measured at 481.25 MHz (note that the related 2-tone IP3 is 3 dB higher than the 3-tone IP3).

Typical Performance Characteristics

(TA = +25 °C, VDD = +5 V, 75 Ω System)

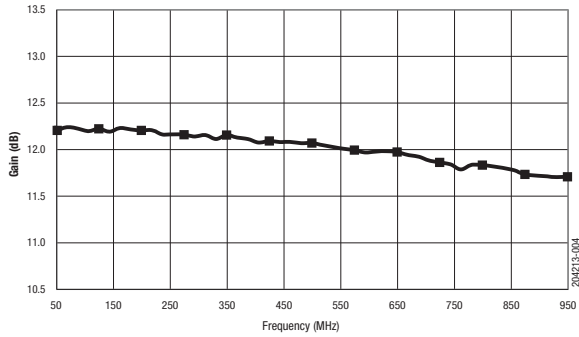

Figure 3. Gain vs Frequency

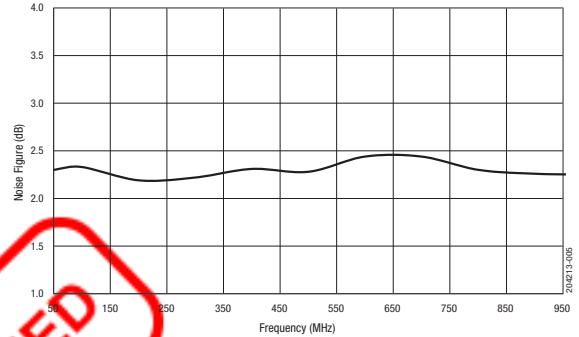

Figure 4. Noise Figure vs Frequency

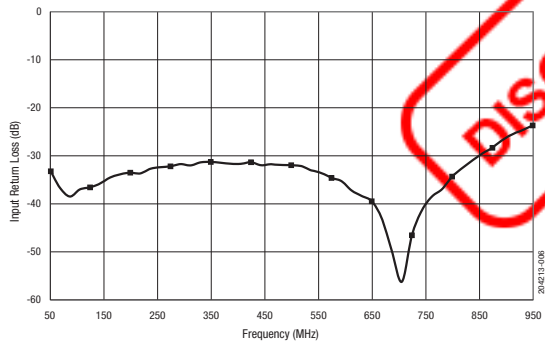

Figure 5. Input Return Loss vs Frequency

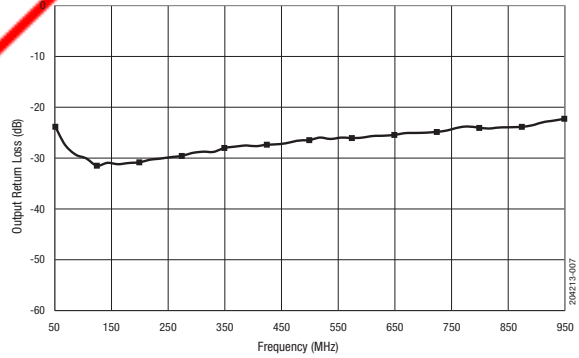

Figure 6. Output Return Loss vs Frequency

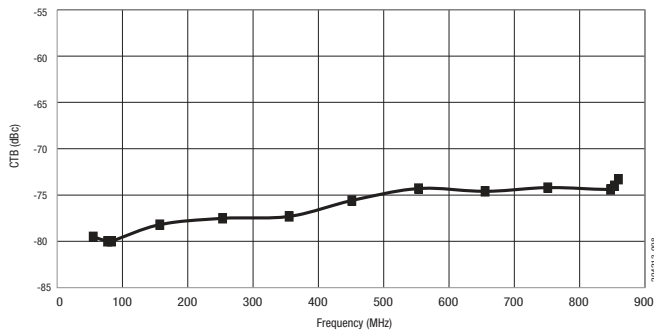

Figure 7. CTB vs Frequency

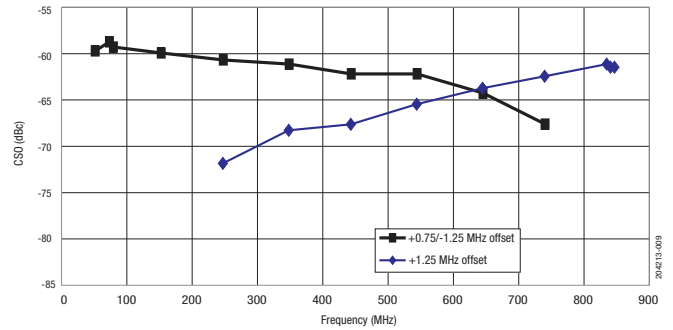

Figure 8. CSO vs Frequency

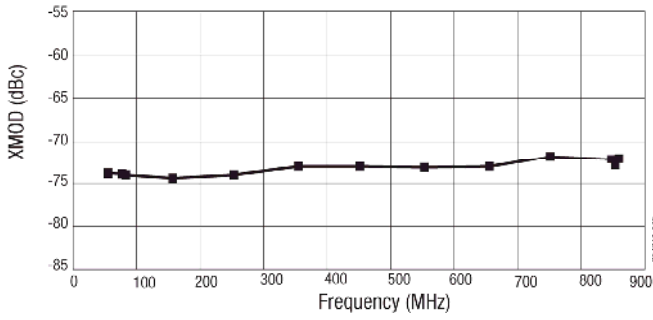

Figure 9. XMOD vs Frequency

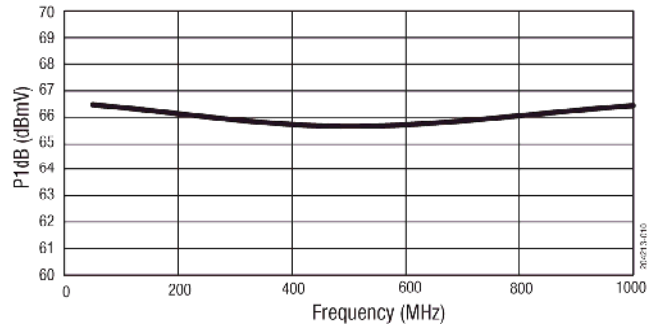

Figure 10. P1dB vs Frequency

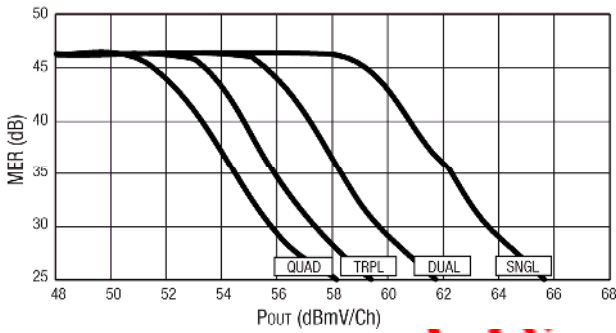

Figure 11. 64 QAM MER vs P_{out}
Test Channel = 86 MHz, TX Channels= 75, 86, 93, 99 MHz

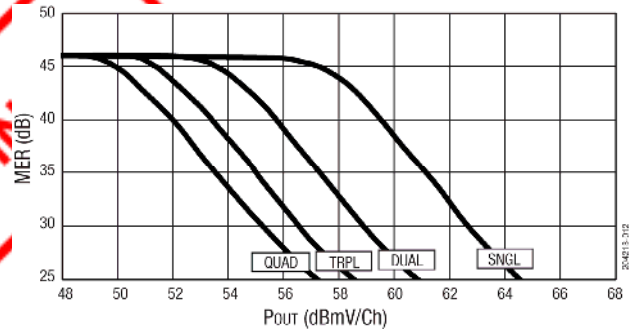

Figure 12. 64 QAM MER vs P_{out}
Test Channel = 543 MHz, TX Channels= 537, 543, 549, 555 MHz

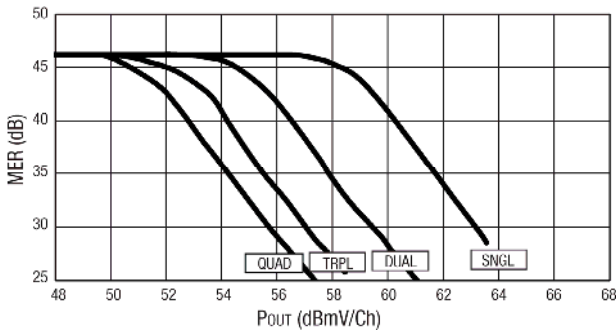

Figure 13. 64 QAM MER vs P_{out}
Test Channel = 987 MHz, TX Channels= 981, 987, 993, 999 MHz

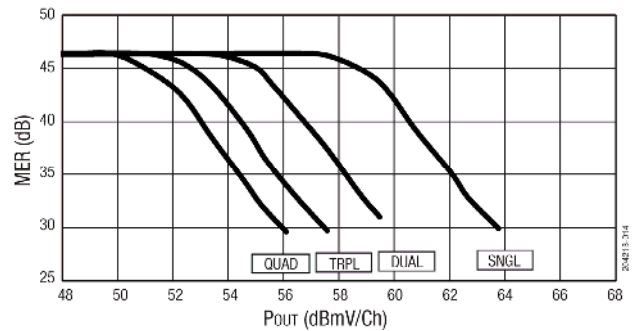

Figure 14. 256 QAM MER vs P_{out}
Test Channel = 86 MHz, TX Channels= 75, 86, 93, 99 MHz

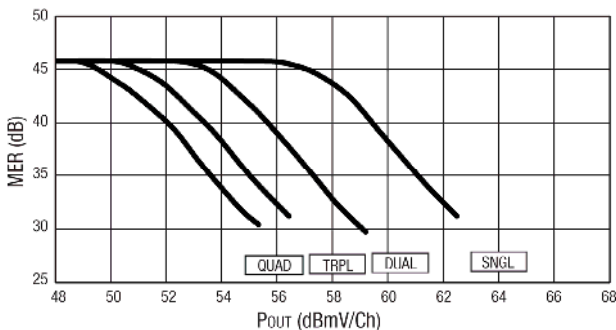

Figure 15. 256 QAM MER vs P_{out}
Test Channel = 543 MHz, TX Channels= 537, 543, 549, 555 MHz

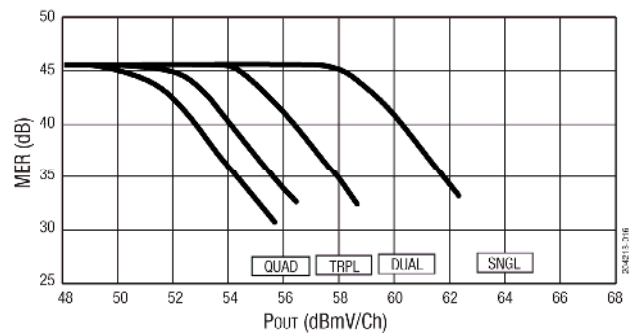

Figure 16. 256 QAM MER vs P_{out}
Test Channel = 987 MHz, TX Channels= 981, 987, 993, 999 MHz

Table 5. Evaluation Board S-Parameters
(TA = +25 °C, VDD = +5.0 VDC, 75 Ω System, Refer to Figure 17)

Frequency MHz	S11		S21		S12		S22		K Factor
	dB	ANG	dB	ANG	dB	ANG	dB	ANG	
25	-17.8	-108.4	11.6	-140.4	-17.2	37.8	-13.0	-146.5	1.01
50	-31.1	-103.9	12.3	-171.3	-16.5	8.8	-23.9	-170.5	1.12
100	-37.9	-37.5	12.3	168.9	-16.5	-8.9	-30.2	-169.0	1.12
150	-35.8	-8.2	12.3	155.8	-16.5	-20.6	-31.0	-155.9	1.12
200	-35.2	-1.9	12.2	144.2	-16.6	-30.4	-30.6	-153.9	1.13
250	-33.6	-1.0	12.2	133.3	-16.6	-39.9	-30.1	-157.2	1.13
300	-32.7	-1.6	12.2	122.9	-16.7	-49.2	-29.1	-160.8	1.13
350	-31.9	-3.2	12.1	112.5	-16.7	-58.0	-28.0	-164.1	1.14
400	-32.0	-11.4	12.1	102.1	-16.7	-66.9	-27.4	-167.7	1.14
450	-32.8	-17.0	12.1	91.8	-16.8	-75.8	-27.0	-172.2	1.15
500	-33.2	-23.2	12.1	81.6	-16.8	-84.8	-26.3	-175.8	1.15
550	-35.9	-33.7	12.0	71.4	-16.9	-93.7	-26.3	-112.0	1.16
600	-40.1	-57.8	12.0	61.2	-17.0	-102.6	-25.7	124.4	1.16
650	-46.2	-113.4	12.0	50.8	-17.1	-111.6	-25.3	174.1	1.17
700	-38.1	145.8	11.9	40.5	-17.1	-121.3	-25.0	39.0	1.18
750	-31.0	127.6	11.8	30.0	-17.2	-129.9	-25.0	174.8	1.19
800	-28.2	117.1	11.8	20.1	-17.3	-138.1	-23.6	163.8	1.20
850	-25.0	107.3	11.7	9.6	-17.5	-147.6	-23.3	166.6	1.21
900	-22.4	97.7	11.7	-0.7	-17.5	-156.9	-23.2	167.7	1.22
950	-20.3	90.3	11.6	-11.4	-17.6	-166.0	-22.2	164.1	1.23
1000	-18.3	82.4	11.5	-22.1	-17.8	-175.6	-20.9	160.4	1.24

Evaluation Board Description

The ADA1200 Evaluation Board is used to test the performance of the ADA1200 device. An Evaluation Board test circuit schematic is provided in Figure 17.

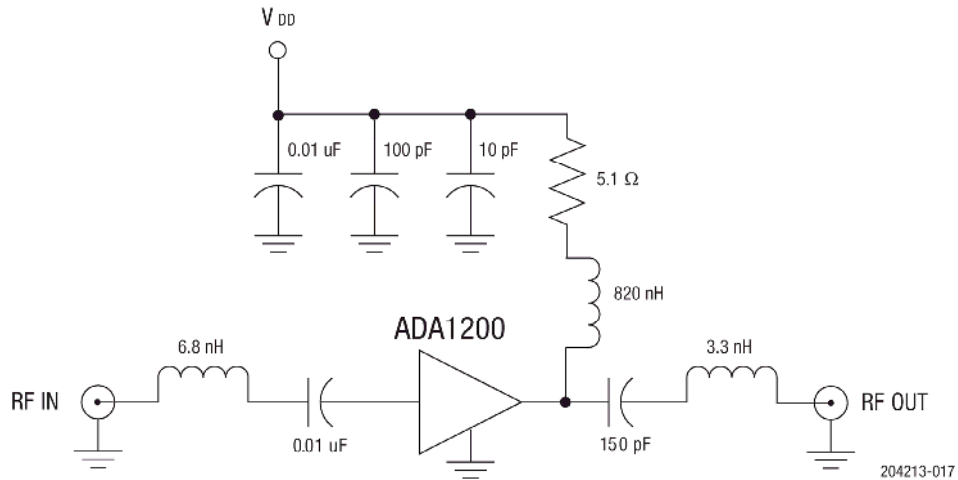

Figure 17. ADA1200 Evaluation Board Schematic

204213-017

Package Dimensions

The package dimensions for the ADA1200 are shown in Figure 18.

Package and Handling Information

Since the device package is sensitive to moisture absorption, it is baked and vacuum packed before shipping. Instructions on the shipping container label regarding exposure to moisture after the container seal is broken must be followed. Otherwise, problems related to moisture absorption may occur when the part is subjected to high temperature during solder assembly.

It can be used for lead or lead-free soldering. For additional information, refer to the Skyworks Application Note, *Solder Reflow Information*, document number 200164.

Care must be taken when attaching this product, whether it is done manually or in a production solder reflow environment. Production quantities of this product are shipped in a standard tape and reel format.

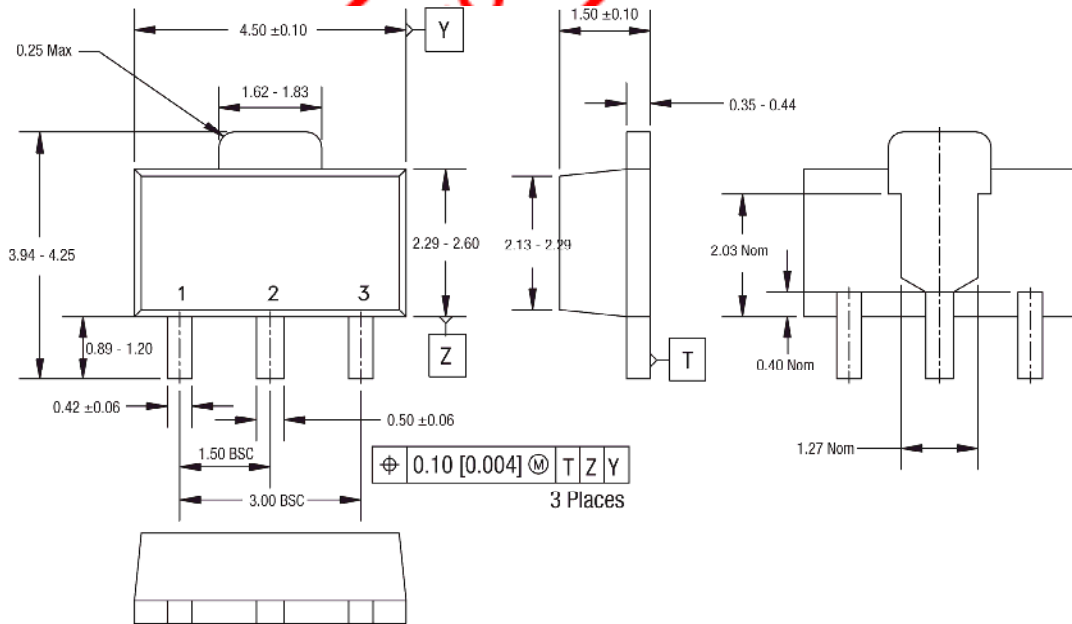

NOTES:

1. CONTROLLING DIMENSIONS: MILLIMETERS.
2. DIMENSIONS DO NOT INCLUDE END FLASH, MOLD FLASH OR MATERIAL PROTRUSIONS.
3. DIMENSION B1, 2 PLACES.
4. DIMENSIONS E1, S, S1 & S2 – REFERENCE ONLY.
5. REFERENCE JEDEC TO-243 (AA).

204213-018

Figure 18. ADA1200 Package Dimensions

Ordering Information

Part Number	Package Description	Component Packaging
ADA1200GS24Q1	SOT-89 package	1000-piece tape and reel
EVB1200		Evaluation Board part number



Copyright © 2017-2018 Skyworks Solutions, Inc. All Rights Reserved.

Information in this document is provided in connection with Skyworks Solutions, Inc. (“Skyworks”) products or services. These materials, including the information contained herein, are provided by Skyworks as a service to its customers and may be used for informational purposes only by the customer. Skyworks assumes no responsibility for errors or omissions in these materials or the information contained herein. Skyworks may change its documentation, products, services, specifications or product descriptions at any time, without notice. Skyworks makes no commitment to update the materials or information and shall have no responsibility whatsoever for conflicts, incompatibilities, or other difficulties arising from any future changes.

No license, whether express, implied, by estoppel or otherwise, is granted to any intellectual property rights by this document. Skyworks assumes no liability for any materials, products or information provided hereunder, including the sale, distribution, reproduction or use of Skyworks products, information or materials, except as may be provided in Skyworks Terms and Conditions of Sale.

THE MATERIALS, PRODUCTS AND INFORMATION ARE PROVIDED “AS IS” WITHOUT WARRANTY OF ANY KIND, WHETHER EXPRESS, IMPLIED, STATUTORY, OR OTHERWISE, INCLUDING FITNESS FOR A PARTICULAR PURPOSE OR USE, MERCHANTABILITY, PERFORMANCE, QUALITY OR NON-INFRINGEMENT OF ANY INTELLECTUAL PROPERTY RIGHT; ALL SUCH WARRANTIES ARE HEREBY EXPRESSLY DISCLAIMED. SKYWORKS DOES NOT WARRANT THE ACCURACY OR COMPLETENESS OF THE INFORMATION, TEXT, GRAPHICS OR OTHER ITEMS CONTAINED WITHIN THESE MATERIALS. SKYWORKS SHALL NOT BE LIABLE FOR ANY DAMAGES, INCLUDING BUT NOT LIMITED TO ANY SPECIAL, INDIRECT, INCIDENTAL, STATUTORY, OR CONSEQUENTIAL DAMAGES, INCLUDING WITHOUT LIMITATION, LOST REVENUES OR LOST PROFITS THAT MAY RESULT FROM THE USE OF THE MATERIALS OR INFORMATION, WHETHER OR NOT THE RECIPIENT OF MATERIALS HAS BEEN ADVISED OF THE POSSIBILITY OF SUCH DAMAGE.

Skyworks products are not intended for use in medical, lifesaving or life-sustaining applications, or other equipment in which the failure of the Skyworks products could lead to personal injury, death, physical or environmental damage. Skyworks customers using or selling Skyworks products for use in such applications do so at their own risk and agree to fully indemnify Skyworks for any damages resulting from such improper use or sale.

Customers are responsible for their products and applications using Skyworks products, which may deviate from published specifications as a result of design defects, errors, or operation of products outside of published parameters or design specifications. Customers should include design and operating safeguards to minimize these and other risks. Skyworks assumes no liability for applications assistance, customer product design, or damage to any equipment resulting from the use of Skyworks products outside of stated published specifications or parameters.

Skyworks and the Skyworks symbol are trademarks or registered trademarks of Skyworks Solutions, Inc. or its subsidiaries in the United States and other countries. Third-party brands and names are for identification purposes only, and are the property of their respective owners. Additional information, including relevant terms and conditions, posted at www.skyworksinc.com, are incorporated by reference.