

917690-1 ✓ ACTIVE

## AMP Signal Double Lock

TE Internal #: 917690-1

Housing, Plug, Wire-to-Wire, 6 Position, .098 in [2.5 mm] Centerline,  
Crimp, 1 Row, Natural, Mating Retention, Wire & Cable, AMP  
Signal Double Lock

[View on TE.com >](#)



Connectors > PCB Connectors > Wire-to-Board Connectors > Wire-to-Board Connector Assemblies & Housings >

STD Temp Signal Double Lock Plug

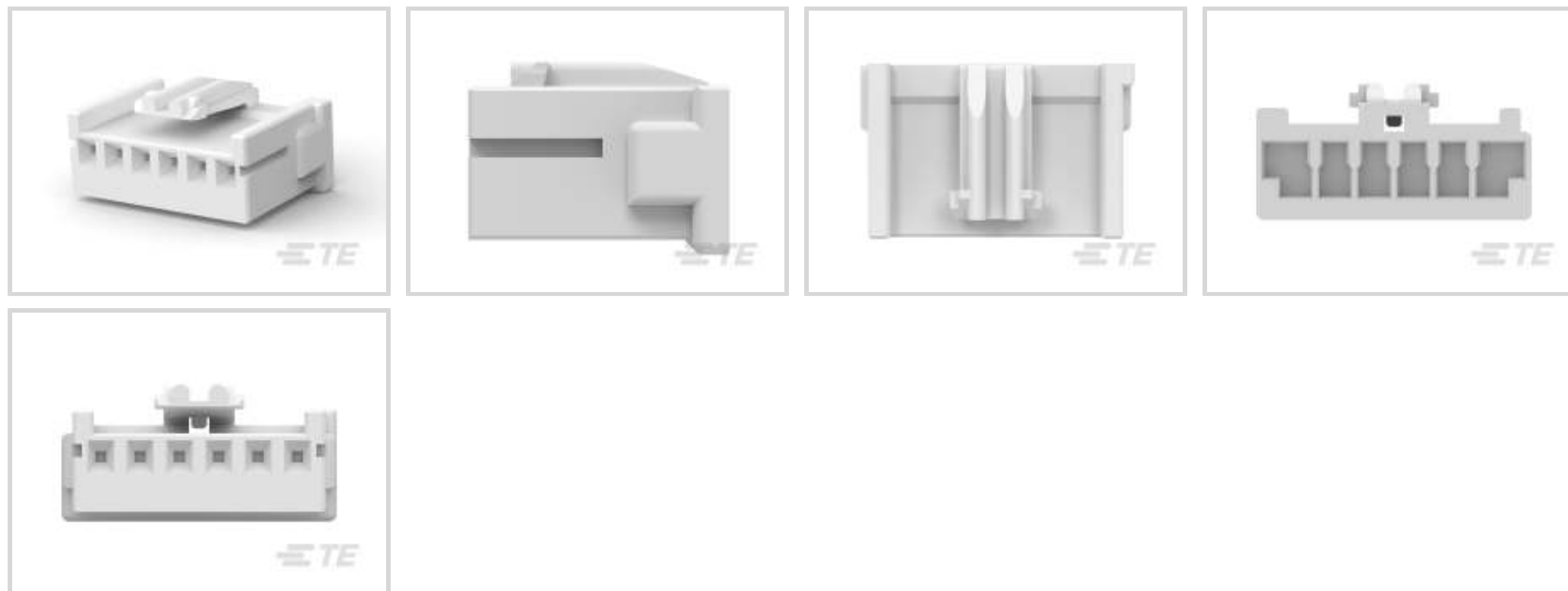

Connector Product Type: **Housing**

Connector & Housing Type: **Plug**

Connector System: **Wire-to-Wire**

Number of Positions: **6**

Centerline (Pitch): **2.5 mm [ .098 in ]**

[All STD Temp Signal Double Lock Plug \(35\)](#)

## Features

### Product Type Features

Connector Product Type	Housing
Connector & Housing Type	Plug
Connector System	Wire-to-Wire
Sealable	No
Connector & Contact Terminates To	Wire & Cable

### Configuration Features

Number of Positions	6
Number of Rows	1

### Electrical Characteristics

Operating Voltage	250 VAC
-------------------	---------

### Body Features

--	--



Primary Product Color	Natural
-----------------------	---------

### Contact Features

Contact Layout	Inline
Contact Type	Socket
Contact Current Rating (Max)	3 A

### Termination Features

Termination Method to Wire & Cable	Crimp
------------------------------------	-------

### Mechanical Attachment

Strain Relief	Without
Mating Retention Type	Latch
Mating Retention	With
Connector Mounting Type	Cable Mount (Free-Hanging)

### Housing Features

Housing Material	Nylon 6/6
Centerline (Pitch)	2.5 mm [.098 in]

### Dimensions

	11 in
Wire Size	.518 mm <sup>2</sup>

### Usage Conditions

Operating Temperature Range	-30 – 105 °C [-22 – 221 °F]
-----------------------------	-----------------------------

### Operation/Application

Circuit Application	Power & Signal
---------------------	----------------

### Industry Standards

Glow Wire Rating	Glow Wire
UL Flammability Rating	UL 94V-0

### Packaging Features

Packaging Quantity	300
Packaging Method	Bag & Box

### Product Compliance

[For compliance documentation, visit the product page on TE.com>](#)









EU RoHS Directive 2011/65/EU	Compliant
EU ELV Directive 2000/53/EC	Compliant
China RoHS 2 Directive MIIT Order No 32, 2016	No Restricted Materials Above Threshold
EU REACH Regulation (EC) No. 1907/2006	Current ECHA Candidate List: JUNE 2023 (235) Candidate List Declared Against: JUNE 2023 (235) Does not contain REACH SVHC
Halogen Content	Low Halogen - Br, Cl, F, I < 900 ppm per homogenous material. Also BFR/CFR/PVC Free
Solder Process Capability	Not applicable for solder process capability

Product Compliance Disclaimer

This information is provided based on reasonable inquiry of our suppliers and represents our current actual knowledge based on the information they provided. This information is subject to change. The part numbers that TE has identified as EU RoHS compliant have a maximum concentration of 0.1% by weight in homogenous materials for lead, hexavalent chromium, mercury, PBB, PBDE, DBP, BBP, DEHP, DIBP, and 0.01% for cadmium, or qualify for an exemption to these limits as defined in the Annexes of Directive 2011/65/EU (RoHS2). Finished electrical and electronic equipment products will be CE marked as required by Directive 2011/65/EU. Components may not be CE marked. Additionally, the part numbers that TE has identified as EU ELV compliant have a maximum concentration of 0.1% by weight in homogenous materials for lead, hexavalent chromium, and mercury, and 0.01% for cadmium, or qualify for an exemption to these limits as defined in the Annexes of Directive 2000/53/EC (ELV). Regarding the REACH Regulation, the information TE provides on SVHC in articles for this part number is based on the latest European Chemicals Agency (ECHA) 'Guidance on requirements for substances in articles' posted at this URL: <https://echa.europa.eu/guidance-documents/guidance-on-reach>

## Compatible Parts

 <p>TE Part # 316090-1 2.5 SIGNAL D/LOCK CAP HSG 6P</p>	 <p>TE Part # CAT-SI261-R2435 Signal Double Lock Receptacle</p>	 <p>TE Part # 917726-1 2.5 S.D.L. P/HDR ASY 6P H/PRO.</p>	 <p>TE Part # 6-1376492-6 2.5 SMC HDR 6POS RED TAPE</p>
 <p>TE Part # 316225-1 2.5 S.D.L HI-PRO V 6P ON/TAPE</p>	 <p>TE Part # 917784-1 2.5 S.D.L POST HDR ASY 6P STD</p>	 <p>TE Part # 917898-1 2.5 S.D.L STD V 6P HDR ON/TAPE</p>	 <p>TE Part # 2-917726-1 2.5 S.D.L HDR ASSY 6P H-PRO</p>



TE Part # 2-917726-4  
2.5 S.D.L HDR ASSY 6P H-PRO



TE Part # 2-917726-6  
2.5 S.D.L HDR ASSY 6P H-PRO



TE Part # 2-917784-1  
2.5 S.D.L POST HDR ASY 6P STD



TE Part # 2-917784-9  
2.5 SDL POST HDR 6P STD W/O BO



TE Part # 316401-1  
2.5 SIGNAL D/L REC CONT. M L/P



TE Part # 917726-4  
2.5 S.D.L HDR ASSY 6P H-PRO



TE Part # 917726-6  
2.5 S.D.L HDR ASSY 6P H-PRO



TE Part # 917784-9  
2.5 S.D.L HDR ASSY 6P STD



TE Part # 234605-1  
EXT-TOOL



TE Part # 316535-1  
2.5 S.D.L HDR V STD 6P IN TUBE



TE Part # 316535-9  
2.5 SDL POST HDR 6P STD I/TUBE



TE Part # 2-917784-2  
2.5 SDL POST HDR 6P STD W/O BO

Also in the Series | AMP Signal Double Lock



Connector Contacts(8)



Connector Seals & Cavity Plugs(10)



Insertion & Extraction Tools(1)



PCB Headers & Receptacles(144)



PCB Latches, Locks & Retainers(17)



Rectangular Caps & Covers(1)



Rectangular Connector Housings(23)



Rectangular Connector Locking(2)



Rectangular Power Connectors(3)

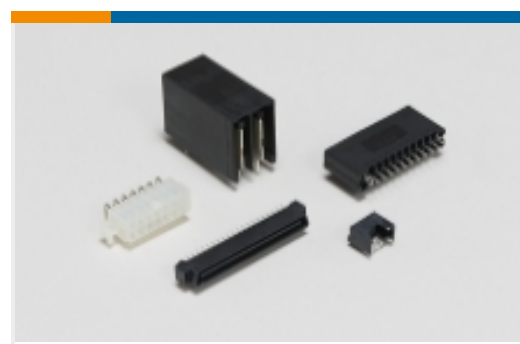

Standard Rectangular Connectors(1)

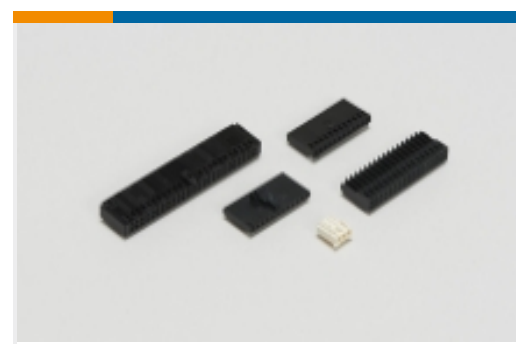

Wire-to-Board Connector Assemblies &amp; Housings(76)



Wire-to-Board Connector Contacts(6)

## Customers Also Bought

TE Part #917692-1  
STD Temp Signal Double Lock PlugTE Part #917708-1  
Signal Double Lock TPA

## Documents

### Product Drawings

#### 2.5 SIGNAL D/LOCK PLUG HSG 6P

English

### CAD Files

#### 3D PDF

3D

#### Customer View Model

[ENG\\_CVM\\_CVM\\_917690-1\\_N.2d\\_dxf.zip](#)

English

#### Customer View Model

[ENG\\_CVM\\_CVM\\_917690-1\\_N.3d\\_igs.zip](#)

English

#### Customer View Model

[ENG\\_CVM\\_CVM\\_917690-1\\_N.3d\\_stp.zip](#)

English

By downloading the CAD file I accept and agree to the [Terms and Conditions](#) of use.

### Datasheets & Catalog Pages

#### SOFT\_SHELL\_PIN\_AND\_SOCKET\_CONNECTORS\_CATALOG

English

#### 1773458-3\_2.5MM\_SIGNAL\_DOUBLE\_LOCK\_CONNECTORS

English

### Product Environmental Compliance

[MD\\_917690-1\\_061120181029\\_dmtec](#)



English

[MD\\_917690-1\\_061120181029\\_dmtec](#)

English

---

**Agency Approvals**

**CSA Certificate**

English

**CSA Certificate**

English