

**FEATURES**

**3 kV rms isolated RS-485/RS-422 transceiver**  
**Low radiated emissions, integrated, isolated dc-to-dc converter**  
**Passes EN 55032 Class B with margin on a 2-layer PCB**  
**Cable invert smart feature**  
**Correct reversed cable connection on A, B, Y, and Z bus pins while maintaining full receiver fail-safe feature**  
**ESD protection on RS-485 A, B, Y and Z pins**  
 **$\geq \pm 12$  kV IEC61000-4-2 contact discharge**  
 **$\geq \pm 15$  kV IEC61000-4-2 air discharge**  
**High speed 25 Mbps data rate (ADM2565E/ADM2567E)**  
**Low speed 500 kbps data rate for EMI control (ADM2561E/ADM2563E)**  
**Flexible power supplies**  
**Input  $V_{CC}$  supply of 3 V to 5.5 V**  
**Logic  $V_{IO}$  supply of 1.7 V to 5.5 V**  
 **$V_{SEL}$  pin to select  $V_{ISO}$  supply of 5 V ( $V_{CC} > 4.5$  V) or 3.3 V**  
**PROFIBUS compliant for 5 V  $V_{ISO}$**   
**Wide operating temperature range:  $-40^{\circ}\text{C}$  to  $+105^{\circ}\text{C}$**   
**High common-mode transient immunity: 250 kV/ $\mu\text{s}$**   
**Short-circuit, open-circuit, and floating input receiver fail-safe**  
**Supports 192 bus nodes (72 k $\Omega$  receiver input impedance)**  
**Full hot swap support (glitch free power-up/power-down)**  
**[Safety and regulatory approvals \(pending\)](#)**  
**CSA Component Acceptance Notice 5A, DIN V VDE V 0884-11, UL 1577, CQC11-471543-2012, IEC 61010-1**  
**Complies with ANSI/TIA/EIA-485-A-98 and ISO 8482:1987(E)**  
**[28-lead, fine pitch SOIC\\_W package \(10.15 mm  \$\times\$  10.05 mm\) with  \$> 8.0\$  mm creepage and clearance](#)**

**APPLICATIONS**

**Heating, ventilation, and air conditioning (HVAC) networks**  
**Industrial field buses**  
**Building automation**  
**Utility networks**  
**Energy meters**

**GENERAL DESCRIPTION**

The ADM2561E, ADM2563E, ADM2565E, and ADM2567E are 3 kV rms signal and power isolated RS-485 transceivers. These devices are designed for balanced transmission lines and comply with ANSI/TIA/EIA-485-A-98 and ISO 8482:1987(E). The devices pass radiated emissions testing to the EN 55032 Class B standard with margin on a 2-layer printed circuit board (PCB) using two small external 0402 ferrites on isolated power and ground pins. The device features an integrated, low electromagnetic interference (EMI), isolated dc-to-dc converter, which eliminates the need for an external isolated power supply. The isolation barrier provides immunity to system level electromagnetic compatibility (EMC) standards. The family of isolator devices features  $\pm 12$  kV contact and  $\pm 15$  kV air IEC61000-4-2 ESD protection on the RS-485 A, B, Y, and Z pins. The devices also features cable invert pins, allowing the user to quickly correct reversed cable connection on the A, B, Y, and Z bus pins while maintaining full receiver fail-safe performance.

Slew rate limited versions are available, which are optimized for low speed over long cable runs, and have a maximum data rate of 500 kbps. Half duplex and full duplex variants are available. The full duplex generics allow independent cable inversion of the driver and receiver for additional flexibility.

Table 18 shows the summary description of each generic.

## TABLE OF CONTENTS

Features.....	1	Robust Low Power Digital Isolator.....	20
Applications .....	1	High Driver Differential Output Voltage.....	20
General Description.....	1	IEC61000-4-2 ESD Protection .....	20
Revision History .....	2	Truth Tables.....	21
Functional Block Diagrams.....	3	Receiver Fail-Safe .....	22
Specifications .....	4	Driver And Receiver Cable Inversion .....	22
Timing Specifications .....	6	Hot Swap Inputs.....	22
Package Characteristics .....	9	192 Transceivers on the Bus .....	23
Regulatory Information.....	9	Driver Output Protection .....	23
Insulation and Safety Related Specifications.....	9	1.7 V To 5.5 V V <sub>IO</sub> Logic Supply .....	23
DIN VDE V 0884-11 (VDE V 0884-11) Insulation		Applications Information .....	24
Characteristics (Pending).....	10	PCB Layout and Electromagnetic Interference (EMI) .....	24
Absolute Maximum Ratings .....	11	Device Power-Up .....	24
Thermal Resistance .....	11	Maximum Data Rate vs. Ambient Temperature .....	24
Electrostatic Discharge (ESD) Ratings .....	11	Isolated PROFIBUS Solution .....	25
ESD Caution.....	11	EMC, EFT, and Surge.....	25
Pin Configurations and Function Descriptions.....	12	Insulation Lifetime.....	25
Typical Performance Characteristics.....	14	Typical Applications .....	26
Test Circuits .....	19	Outline Dimensions.....	28
Theory of Operation .....	20	Ordering Guide .....	28
Low EMI Integrated DC-to-DC Converter.....	20		

## REVISION HISTORY

### 8/2020—Rev. A to Rev. B

Changed ADM2565E Status and ADM2567E Status from Pending to Released .....	Throughout
Changes to Features Section and General Description Section .....	1
Changes to Table 5.....	9
Changes to 192 Transceivers on the Bus Section.....	23
Changes to Ordering Guide.....	28
Deleted Pending Products Section and Table 22 .....	29

### 6/2020—Rev. 0 to Rev. A

Changes to General Description Section .....	1
Changes to DIN VDE V 0884-11 (VDE V 0884-11) Insulation Characteristics (Pending) Section.....	10
Changes to Table 8.....	11
Added Electrostatic Discharge (ESD) Ratings Section, ESD Ratings for ADM2561E/ADM2563E/ADM2565E/ADM2567E Section, and Table 11; Renumbered Sequentially.....	11
Changes to Ordering Guide.....	28
Changes to Table 21 .....	29

### 5/2020—Revision 0: Initial Version

FUNCTIONAL BLOCK DIAGRAMS

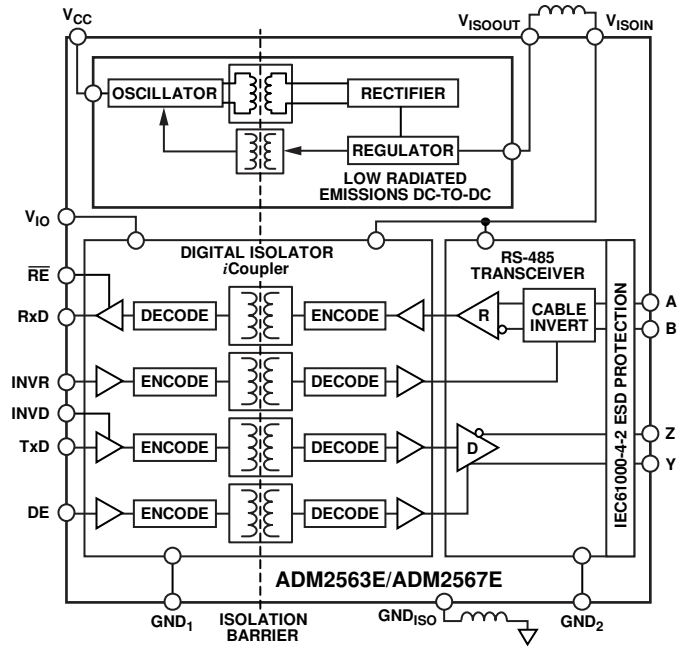

Figure 1. ADM2563E/ADM2567E

22764-001

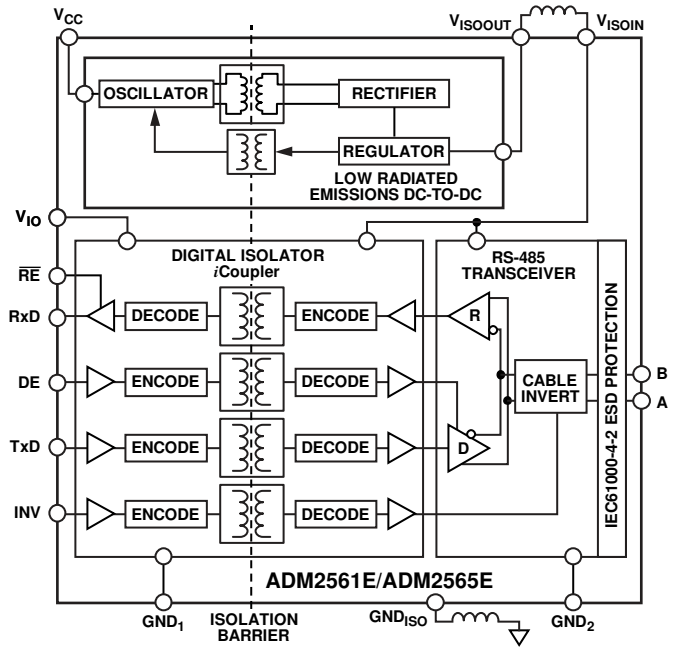

Figure 2. ADM2561E/ADM2565E

22764-101

**SPECIFICATIONS**

All voltages are relative to their respective ground:  $3.0\text{ V} \leq V_{CC} \leq 5.5\text{ V}$ ,  $1.7\text{ V} \leq V_{IO} \leq 5.5\text{ V}$ ,  $T_{MIN} (-40^{\circ}\text{C})$  to  $T_{MAX} (+105^{\circ}\text{C})$ . All minimum and maximum specifications apply over the entire recommended operation range, unless otherwise noted. All typical specifications are at  $T_A = 25^{\circ}\text{C}$ ,  $V_{CC} = V_{IO} = 5\text{ V}$ ,  $V_{ISOOUT}$  output voltage ( $V_{ISO}$ ) = 3.3 V ( $V_{SEL} = GND_{ISO}$ ), unless otherwise noted. All parameters are characterized with a BLM15HD182SN1 ferrite bead between the  $V_{ISOOUT}$  and  $V_{ISOIN}$  pins, and between the  $GND_{ISO}$  and  $GND_2$  pins.

Table 1.

Parameter	Symbol	Min	Typ	Max	Unit	Test Conditions/Comments
<b>PRIMARY SUPPLY CURRENT</b>						
$V_{CC}$ Supply Current—Unloaded	$I_{CC}$		21	46	mA	$V_{SEL} = GND_{ISO}$ (DE = 0 V)
			28	48	mA	$V_{CC} \geq 4.5\text{ V}$ , $V_{SEL} = V_{ISO}$ (DE = 0 V)
			20	53	mA	$V_{SEL} = GND_{ISO}$ (DE = $V_{IO}$ )
			26	51	mA	$V_{CC} \geq 4.5\text{ V}$ , $V_{SEL} = V_{ISO}$ (DE = $V_{IO}$ )
$V_{IO}$ Logic Supply Current	$I_{IO}$		0.65	0.9	mA	DE = 0 V
			5	8	mA	DE = $V_{IO}$
<b>ISOLATED SUPPLY CURRENT</b>						
ADM2561E/ADM2563E (Data Rate = 500 kbps)	$I_{SOIN}$		50	75		$V_{SOIN} = 3\text{ V}$ to 3.465 V, 54 $\Omega$ between Y and Z
ADM2565E/ADM2567E (Data Rate = 25 Mbps)			55	75	mA	$V_{SOIN} = 3\text{ V}$ to 3.465 V, 54 $\Omega$ between Y and Z
<b>ISOLATED DC-TO-DC CONVERTER</b>						
$V_{ISOOUT}$ Output Voltage	$V_{ISO}$	3	3.3	3.465	V	$V_{SEL} = GND_{ISO}$ , $I_{ISOOUT} = 10\text{ mA}$ minimum to 55 mA maximum <sup>1</sup>
		4.5	5.0	5.25	V	$V_{CC} \geq 4.5\text{ V}$ , $V_{SEL} = V_{ISO}$ , $I_{ISOOUT} = 10\text{ mA}$ minimum to 90 mA maximum <sup>1</sup>
Output Current Available from $V_{ISOOUT}$ Supply Pin	$I_{SOOUT}$	90			mA	$V_{CC} \geq 4.5\text{ V}$ , $V_{SEL} = V_{ISO}$ , $V_{ISO} \geq 4.5\text{ V}$
$V_{CC}$ Minimum Start-Up Voltage Start-Up Time	$V_{START}$	3.135			V	DE = $GND_1$ , see the Device Power-Up section
	$t_{START}$		10		ms	DE = $GND_1$ , see the Device Power-Up section
<b>DRIVER</b>						
Differential Output Voltage Loaded	$ V_{OD2} $	2.0	2.4	$V_{ISO}$	V	$V_{CC} \geq 3.0\text{ V}$ , $V_{SEL} = GND_{ISO}$ , $R_L = 100\ \Omega$ , see Figure 40
		1.5	2	$V_{ISO}$	V	$V_{CC} \geq 3.0\text{ V}$ , $V_{SEL} = GND_{ISO}$ , $R_L = 54\ \Omega$ , see Figure 40
		2.1	3.1	$V_{ISO}$	V	$V_{CC} \geq 4.5\text{ V}$ , $V_{SEL} = V_{ISO}$ , $R_L = 54\ \Omega$ , see Figure 40
Over Common-Mode Range	$ V_{OD3} $	1.5	1.9	$V_{ISO}$	V	$V_{CC} \geq 3.0\text{ V}$ , $V_{SEL} = GND_{ISO}$ , $-7\text{ V} \leq$ common-mode voltage ( $V_{CM}$ ) $\leq 12\text{ V}$ , see Figure 41
		2.1	3.1	$V_{ISO}$	V	$V_{CC} \geq 4.5\text{ V}$ , $V_{SEL} = V_{ISO}$ , $-7\text{ V} \leq V_{CM} \leq 12\text{ V}$ , see Figure 41
$\Delta V_{OD2} $ for Complementary Output States	$\Delta V_{OD2} $			0.2	V	$R_L = 54\ \Omega$ or $100\ \Omega$ , see Figure 40
Common-Mode Output Voltage	$V_{OC}$		1.5	3.0	V	$R_L = 54\ \Omega$ or $100\ \Omega$ , see Figure 40
$\Delta V_{OC} $ for Complementary Output States	$\Delta V_{OC} $			0.2	V	$R_L = 54\ \Omega$ or $100\ \Omega$ , see Figure 40
Short-Circuit Output Current	$I_{OS}$	-250		+250	mA	$-7\text{ V} \leq$ output voltage ( $V_O$ ) $\leq +12\text{ V}$
Output Leakage Current (Y, Z) <sup>2</sup>	$I_O$		1	50	$\mu\text{A}$	DE = $\overline{RE} = 0\text{ V}$ , $V_{CC} = 0\text{ V}$ or 5.5 V, $V_{IN} = 12\text{ V}$
		-50	10		$\mu\text{A}$	DE = $\overline{RE} = 0\text{ V}$ , $V_{CC} = 0\text{ V}$ or 5.5 V, $V_{IN} = -7\text{ V}$
Pin Capacitance (A, B, Y, Z)	$C_{IN}$		28		pF	Input voltage ( $V_{IN}$ ) = $0.4\sin(10\pi t \times 10^6)$
<b>RECEIVER</b>						
Differential Input Threshold Voltage, Noninverted	$V_{TH}$	-200	-125	-30	mV	$-7\text{ V} \leq V_{CM} \leq +12\text{ V}$ , INV/INVR = 0 V
Differential Input Threshold Voltage, Inverted		30	125	200	mV	$-7\text{ V} \leq V_{CM} \leq +12\text{ V}$ , INV/INVR = $V_{IO}$
Input Voltage Hysteresis	$V_{HYS}$		25		mV	$-7\text{ V} \leq V_{CM} \leq +12\text{ V}$
Input Current (A, B)	$I_I$			167	$\mu\text{A}$	DE = 0 V, $V_{CC} =$ powered/unpowered, $V_{IN} = 12\text{ V}$
		-133			$\mu\text{A}$	DE = 0 V, $V_{CC} =$ powered/unpowered, $V_{IN} = -7\text{ V}$
Pin Capacitance (A, B)	$C_{IN}$		4		pF	Input voltage ( $V_{IN}$ ) = $0.4\sin(10\pi t \times 10^6)$

Parameter	Symbol	Min	Typ	Max	Unit	Test Conditions/Comments
DIGITAL LOGIC INPUTS						
Input Low Voltage	$V_{IL}$			$0.3 \times V_{IO}$	V	DE, $\overline{RE}$ , TxD, INV, INVR, INVD
Input High Voltage	$V_{IH}$	$0.7 \times V_{IO}$			V	DE, $\overline{RE}$ , TxD, INV, INVR, INVD
Input Leakage Current	$I_{li}$	-1	0.1	2	$\mu A$	DE, $\overline{RE}$ , TxD, $V_{IN} = 0 V$ or $V_{IO}$
		-1	10	30	$\mu A$	INV, INVR, INVD, $V_{IN} = 0 V$ or $V_{IO}$
RxD DIGITAL OUTPUT						
Output Low Voltage	$V_{OL}$			0.4	V	$V_{IO} = 3.6 V$ , output current ( $I_{OUT}$ ) = 2.0 mA, differential input voltage ( $V_{ID}$ ) $\leq -0.2 V$
				0.4	V	$V_{IO} = 2.7 V$ , $I_{OUT} = 1.0 mA$ , $V_{ID} \leq -0.2 V$
				0.2	V	$V_{IO} = 1.95 V$ , $I_{OUT} = 500 \mu A$ , $V_{ID} \leq -0.2 V$
					V	$V_{IO} = 3.0 V$ , $I_{OUT} = -2.0 mA$ , $V_{ID} \geq -0.03 V$
Output High Voltage	$V_{OH}$	2.4			V	$V_{IO} = 3.0 V$ , $I_{OUT} = -2.0 mA$ , $V_{ID} \geq -0.03 V$
		2.0			V	$V_{IO} = 2.3 V$ , $I_{OUT} = -1.0 mA$ , $V_{ID} \geq -0.03 V$
		$V_{IO} - 0.2$			V	$V_{IO} = 1.7 V$ , $I_{OUT} = -500 \mu A$ , $V_{ID} \geq -0.03 V$
Short-Circuit Current			100	mA	$V_O = 0 V$ or $V_{IO}$ , $\overline{RE} = 0 V$	
Three-State Output Leakage Current	$I_{OZR}$	-1	+0.01	+1	$\mu A$	$\overline{RE} = V_{IO}$ , RxD = 0 V or $V_{IO}$
COMMON-MODE TRANSIENT IMMUNITY <sup>3</sup>	CMTI	250			kV/ $\mu s$	$V_{CM} \geq \pm 1 kV$ , transient magnitude measured at between 20% and 80% of $V_{CM}$ , see Figure 46 and Figure 47

<sup>1</sup> These parameters include the voltage drop across the dc resistance of the BLM15HD182SN1 ferrite beads.

<sup>2</sup> The ADM2563E and ADM2567E only.

<sup>3</sup> CMTI is the maximum common-mode voltage slew rate that can be sustained while maintaining specification compliant operation.  $V_{CM}$  is the common-mode potential difference between the logic and bus sides. The transient magnitude is the range over which the common mode is slewed. The common-mode voltage slew rates apply to both rising and falling common-mode voltage edges.

**TIMING SPECIFICATIONS**

**ADM2565E/ADM2567E**

All minimum and maximum specifications apply over the entire recommended operation range,  $V_{CC} = 3.0\text{ V to }5.5\text{ V}$ ,  $V_{IO} = 1.7\text{ V to }5.5\text{ V}$ ,  $T_A = T_{MIN} (-40^\circ\text{C})$  to  $T_{MAX} (+105^\circ\text{C})$ . All typical specifications are at  $T_A = 25^\circ\text{C}$ ,  $V_{CC} = V_{IO} = 5\text{ V}$ ,  $V_{ISO} = 3.3\text{ V}$  ( $V_{SEL} = \text{GND}_{ISO}$ ). All parameters are characterized with a BLM15HD182SN1 ferrite bead between the  $V_{ISOOUT}$  and  $V_{ISOIN}$  pins, and between the  $\text{GND}_{ISO}$  and  $\text{GND}_2$  pins.

**Table 2.**

Parameter	Symbol	Min	Typ	Max	Unit	Test Conditions/Comments
<b>DRIVER</b>						
Maximum Data Rate		25			Mbps	
Propagation Delay	$t_{DPLH}, t_{DPHL}$		18	25	ns	$R_L = 54\ \Omega, C_{L1} = C_{L2} = 100\text{ pF}$ , see Figure 3 and Figure 42
Output Skew	$t_{SKEW}$		1.5	5	ns	$R_L = 54\ \Omega, C_{L1} = C_{L2} = 100\text{ pF}$ , see Figure 3 and Figure 42
Rise Time/Fall Time	$t_{DR}, t_{DF}$		4.5	10	ns	$R_L = 54\ \Omega, C_{L1} = C_{L2} = 100\text{ pF}$ , see Figure 3 and Figure 42
Enable Time	$t_{ZL}, t_{ZH}$		25	40	ns	$R_L = 110\ \Omega, C_L = 50\text{ pF}$ , see Figure 5 and Figure 43
Disable Time	$t_{LZ}, t_{HZ}$		20	40	ns	$R_L = 110\ \Omega, C_L = 50\text{ pF}$ , see Figure 5 and Figure 43
<b>RECEIVER</b>						
Propagation Delay	$t_{RPLH}, t_{RPHL}$		32	50	ns	$C_L = 15\text{ pF}$ , see Figure 4 and Figure 44
Output Skew	$t_{SKEW}$		2	6	ns	$C_L = 15\text{ pF}$ , see Figure 4 and Figure 44
Enable Time	$t_{ZL}, t_{ZH}$		4	25	ns	$R_L = 1\text{ k}\Omega, C_L = 15\text{ pF}$ , see Figure 6 and Figure 45
Disable Time	$t_{LZ}, t_{HZ}$		8	25	ns	$R_L = 1\text{ k}\Omega, C_L = 15\text{ pF}$ , see Figure 6 and Figure 45
<b>RECEIVER CABLE INVERT, INVR</b>						
Propagation Delay						
High to Low	$t_{INVRPHL}$		25	35	ns	$V_{ID} \geq +200\text{ mV}$ or $V_{ID} \leq -200\text{ mV}$ , see Figure 7
Low to High	$t_{INVRPLH}$		25	35	ns	$V_{ID} \geq +200\text{ mV}$ or $V_{ID} \leq -200\text{ mV}$ , see Figure 7
<b>DRIVER CABLE INVERT, INVD</b>						
Propagation Delay						
High to Low	$t_{INVDPHL}$		18	25	ns	$\text{TxD} = 0\text{ V}$ or $\text{TxD} = V_{IO}$ , see Figure 8
Low to High	$t_{INVDPLH}$		18	25	ns	$\text{TxD} = 0\text{ V}$ or $\text{TxD} = V_{IO}$ , see Figure 8

**ADM2561E/ADM2563E**

All minimum and maximum specifications apply over the entire recommended operation range,  $V_{CC} = 3.0\text{ V to }5.5\text{ V}$ ,  $V_{IO} = 1.7\text{ V to }5.5\text{ V}$ ,  $T_A = T_{MIN} (-40^\circ\text{C})$  to  $T_{MAX} (+105^\circ\text{C})$ . All typical specifications are at  $T_A = 25^\circ\text{C}$ ,  $V_{CC} = V_{IO} = 5\text{ V}$ ,  $V_{ISO} = 3.3\text{ V}$  ( $V_{SEL} = \text{GND}_{ISO}$ ).

**Table 3.**

Parameter	Symbol	Min	Typ	Max	Unit	Test Conditions/Comments
<b>DRIVER</b>						
Maximum Data Rate		500			kbps	
Propagation Delay	$t_{DPLH}, t_{DPHL}$		220	400	ns	$R_L = 54\ \Omega, C_{L1} = C_{L2} = 100\text{ pF}$ , see Figure 3 and Figure 42
Output Skew	$t_{SKEW}$		5	100	ns	$R_L = 54\ \Omega, C_{L1} = C_{L2} = 100\text{ pF}$ , see Figure 3 and Figure 42
Rise Time/Fall Time	$t_{DR}, t_{DF}$	200	280	600	ns	$R_L = 54\ \Omega, C_{L1} = C_{L2} = 100\text{ pF}$ , see Figure 3 and Figure 42
Enable Time	$t_{ZL}, t_{ZH}$		130	1000	ns	$R_L = 110\ \Omega, C_L = 50\text{ pF}$ , see Figure 5 and Figure 43
Disable Time	$t_{LZ}, t_{HZ}$		800	2000	ns	$R_L = 110\ \Omega, C_L = 50\text{ pF}$ , see Figure 5 and Figure 43
<b>RECEIVER</b>						
Propagation Delay	$t_{RPLH}, t_{RPHL}$		35	200	ns	$C_L = 15\text{ pF}$ , see Figure 4 and Figure 44
Output Skew	$t_{SKEW}$		2	50	ns	$C_L = 15\text{ pF}$ , see Figure 4 and Figure 44
Enable Time	$t_{ZL}, t_{ZH}$		10	100	ns	$R_L = 1\text{ k}\Omega, C_L = 15\text{ pF}$ , see Figure 6 and Figure 45
Disable Time	$t_{LZ}, t_{HZ}$		10	100	ns	$R_L = 1\text{ k}\Omega, C_L = 15\text{ pF}$ , see Figure 6 and Figure 45
<b>RECEIVER CABLE INVERT, INVR</b>						
Propagation Delay						
High to Low	$t_{INVRPHL}$		25	200	ns	$V_{ID} \geq +200\text{ mV}$ or $V_{ID} \leq -200\text{ mV}$ , see Figure 7
Low to High	$t_{INVRPLH}$		25	200	ns	$V_{ID} \geq +200\text{ mV}$ or $V_{ID} \leq -200\text{ mV}$ , see Figure 7
<b>DRIVER CABLE INVERT, INVD</b>						
Propagation Delay						
High to Low	$t_{INVDPHL}$		220	400	ns	$\text{TxD} = 0\text{ V}$ or $\text{TxD} = V_{IO}$ , see Figure 8
Low to High	$t_{INVDPLH}$		220	400	ns	$\text{TxD} = 0\text{ V}$ or $\text{TxD} = V_{IO}$ , see Figure 8

Timing Diagrams

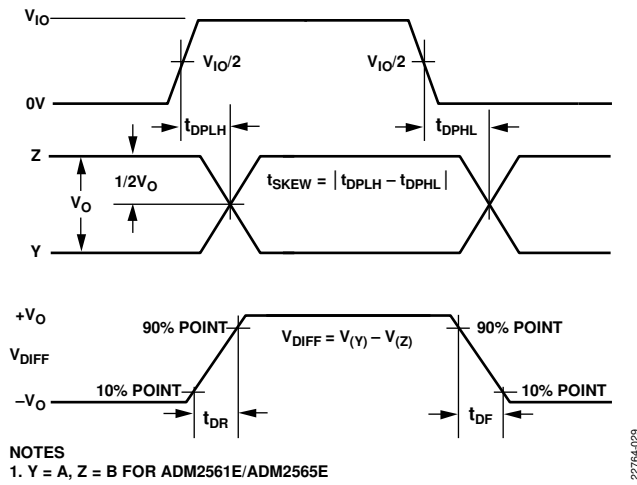

Figure 3. Driver Propagation Delay, Rise/Fall Timing (See Figure 42 for Test Circuit)

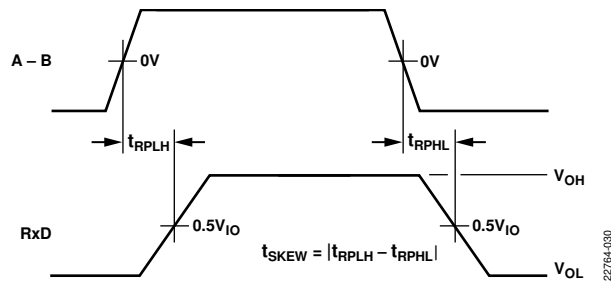

Figure 4. Receiver Propagation Delay (See Figure 44 for Test Circuit)

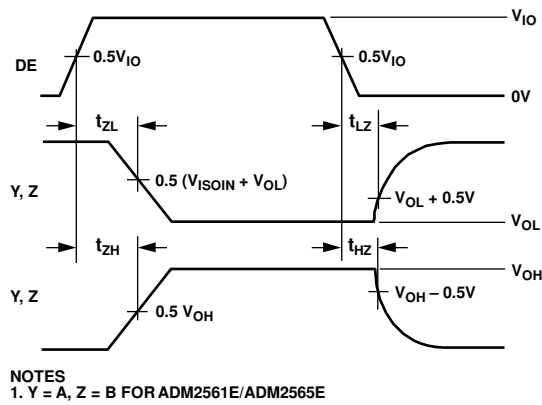

Figure 5. Driver Enable or Disable Timing (See Figure 43 for Test Circuit)

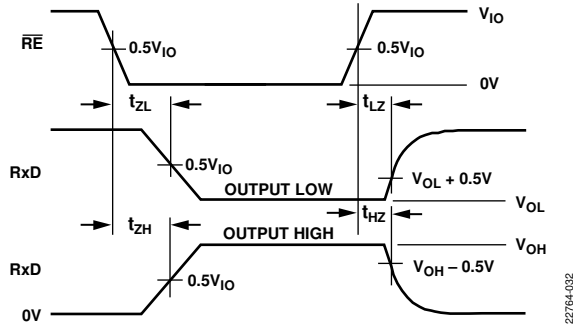
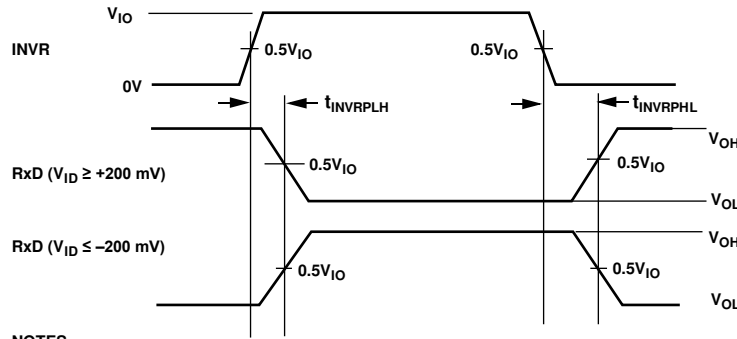
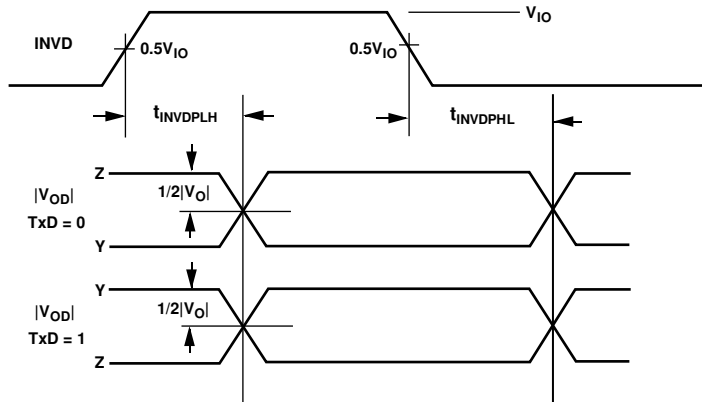

Figure 6. Receiver Enable or Disable Timing (See Figure 45 for Test Circuit)



NOTES  
1. INVR = INV FOR ADM2561E/ADM2565E

Figure 7. Receiver Cable Invert Timing



NOTES  
1. INVD = INV, Y = A, Z = B FOR ADM2561E/ADM2565E

Figure 8. Driver Cable Invert Timing



**PACKAGE CHARACTERISTICS**

Table 4.

Parameter	Symbol	Min	Typ	Max	Unit	Test Conditions/Comments
Resistance (Input to Output) <sup>1</sup>	R <sub>I-O</sub>		10 <sup>13</sup>		Ω	
Capacitance (Input to Output) <sup>1</sup>	C <sub>I-O</sub>		2.2		pF	f = 1 MHz
Input Capacitance <sup>2</sup>	C <sub>I</sub>		3.0		pF	Input capacitance

<sup>1</sup> Device considered a 2-terminal device: short together Pin 1 to Pin 14 and short together Pin 15 to Pin 28.

<sup>2</sup> Input capacitance is from any input data pin to ground.

**REGULATORY INFORMATION**

For additional information, see [www.analog.com/icouplersafety](http://www.analog.com/icouplersafety).

Table 5. ADM2561E/ADM2563E/ADM2565E/ADM2567E Approvals

UL (Pending)	CSA (Pending)	VDE (Pending)	CQC (Pending)
Recognized Under UL 1577 Component Recognition Program <sup>1</sup>	Approved under CSA Component Acceptance Notice 5A	To be certified under DIN V VDE 0884-11 <sup>2</sup>	Certified under CQC11-471543-2012
Single Protection, 3 kV rms	CSA 62368-1-14, EN 62368-1:2014/A11:2017 and IEC 62368-1:2014 second edition: Basic insulation at 800 V rms (1131 V peak)  Reinforced insulation at 400 V rms (565 V peak) IEC 60601-1 Edition 3.1: 1 means of patient protection (MOPP), 250 V rms (354 V peak) CSA 61010-1-12 and IEC 61010-1 third edition: Basic insulation at 300 V rms mains, 800 V rms (1131 V peak) from secondary circuit Reinforced insulation at 300 V rms mains, 400 V rms (565 V peak) from secondary circuit	Basic insulation:  Working voltage (V <sub>IOWM</sub> ) = 400 V rms  Repetitive maximum voltage (V <sub>IORM</sub> ) = 565 V peak Surge isolation voltage (V <sub>IOSM</sub> ) = 10 kV peak Highest allowable overvoltage (V <sub>IOTM</sub> ) = 8000 V peak  Reinforced insulation: Working voltage (V <sub>IOWM</sub> ) = 330 V rms Repetitive maximum voltage (V <sub>IORM</sub> ) = 466 V peak Surge isolation voltage (V <sub>IOSM</sub> ) = 6.25 kV peak Highest allowable overvoltage (V <sub>IOTM</sub> ) = 8000 V peak	GB4943.1-2011:  Basic insulation at 800 V rms (1131 V peak) Reinforced insulation at 400 V rms (565 V peak)
File (Pending)	File 205078 (basic, reinforced pending)	File (pending)	File (pending)

<sup>1</sup> In accordance with UL 1577, each ADM2561E/ADM2563E/ADM2565E/ADM2567E is proof tested by applying an insulation test voltage ≥ 3600 V rms for 1 sec.

<sup>2</sup> In accordance with DIN V VDE 0884-11, each ADM2561E/ADM2563E/ADM2565E/ADM2567E is proof tested by applying an insulation test voltage ≥ 1060 V peak for 1 sec (partial discharge detection limit = 5 pC).

**INSULATION AND SAFETY RELATED SPECIFICATIONS**

Table 6. Critical Safety Related Dimensions and Material Properties

Parameter	Symbol	Value	Unit	Test Conditions/Comments
Rated Dielectric Insulation Voltage		3	kV rms	1-minute duration
Minimum External Air Gap (Clearance)	L(I01)	8.3	mm	Measured from input terminals to output terminals, shortest distance through air
Minimum External Tracking (Creepage)	L(I02)	8.3	mm	Measured from input terminals to output terminals, shortest distance along body
Minimum Clearance in the Plane of the Printed Circuit Board (PCB Clearance)	L (PCB)	8.1	mm	Measured from input terminals to output terminals, shortest distance through air, line of sight, in the PCB mounting plane
Minimum Internal Gap (Internal Clearance)		22	μm min	Insulation distance through insulation
Tracking Resistance (Comparative Tracking Index)	CTI	>600	V	DIN IEC 112/VDE 0303 Part 1
Material Group		I		Material Group (DIN VDE 0110: 1989-01, Table 1)

**DIN VDE V 0884-11 (VDE V 0884-11) INSULATION CHARACTERISTICS (PENDING)**

The ADM2561E/ADM2563E/ADM2565E/ADM2567E are suitable for reinforced electrical isolation only within the safety limit data. Maintenance of the safety data must be ensured by means of protective circuits. The asterisk (\*) marking on packages denotes DIN VDE V 0884-11 approval.

Table 7.

Description	Test Conditions/Comments	Symbol	Characteristic	Unit
<b>CLASSIFICATIONS</b>				
Installation Classification per DIN VDE V 0110 for Rated Mains Voltage			I to IV	
≤150 V rms			I to II	
≤300 V rms			I	
≤400 V rms			40/105/21	
Climatic Classification			2	
Pollution Degree	Per DIN VDE V 0110, Table 1			
<b>VOLTAGE</b>				
Maximum Working Insulation Voltage		$V_{IOWM}$	400	V rms
Maximum Repetitive Peak Insulation Voltage		$V_{IORM}$	565	V peak
Input to Output Test Voltage		$V_{PR}$		
Method b1	$V_{IORM} \times 1.875 = V_{PR}$ , 100% production tested, $t_m = 1$ sec, partial discharge < 5 pC		1060	V peak
Method a				
After Environmental Tests, Subgroup 1	$V_{IORM} \times 1.5 = V_{pd(m)}$ , $t_{ini} = 60$ sec, $t_m = 10$ sec, partial discharge < 5 pC		848	V peak
After Input and/or Safety Test, Subgroup 2/Subgroup 3	$V_{IORM} \times 1.2 = V_{pd(m)}$ , $t_{ini} = 60$ sec, $t_m = 10$ sec, partial discharge < 5 pC		678	V peak
Highest Allowable Overvoltage	Transient overvoltage, $t_{TR} = 10$ sec	$V_{IOTM}$	8000	V peak
Surge Isolation Voltage, Basic	Peak voltage ( $V_{PEAK}$ ) = 10 kV, 1.2 $\mu$ s rise time, 50 $\mu$ s, 50% fall time	$V_{IOSM}$	10,000	V peak
Surge Isolation Voltage, Reinforced	$V_{PEAK} = 10$ kV, 1.2 $\mu$ s rise time, 50 $\mu$ s, 50% fall time	$V_{IOSM}$	6250	V peak
<b>SAFETY LIMITING VALUES</b>				
Case Temperature	Maximum value allowed in the event of a failure	$T_s$	150	°C
Total Power Dissipation at $T_A = 25^\circ\text{C}$		$P_s$	2.87	W
Insulation Resistance at $T_s$	$V_{IO} = 500$ V	$R_s$	>10 <sup>9</sup>	$\Omega$

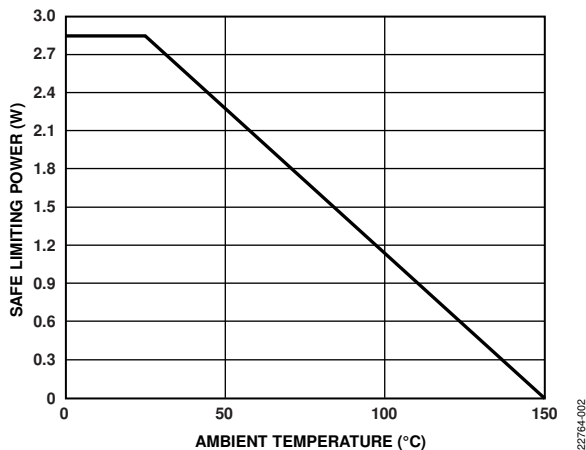

Figure 9. Thermal Derating Curve for 28-Lead Standard Small Outline, Wide Body, with Finer Pitch (SOIC\_W\_FP), Dependence of Safety Limiting Values with Ambient Temperature per DIN VDE V 0884-11

## ABSOLUTE MAXIMUM RATINGS

$T_A = 25^\circ\text{C}$ , unless otherwise noted. All voltages are relative to their respective ground.

Table 8.

Parameter	Rating
$V_{CC}$ to $GND_1$	-0.5 V to +6.0 V
$V_{IO}$ to $GND_1$	-0.5 V to +7.0 V
Digital Input Voltage ( $DE$ , $\overline{RE}$ , $TxD$ , $INV$ , $INVR$ , $INVD$ ) to $GND_1$	-0.3 V to $V_{IO} + 0.3$ V
Digital Output Voltage ( $RxD$ ) to $GND_1$	-0.3 V to $V_{IO} + 0.3$ V
Driver Output/Receiver Input Voltage ( $A$ , $B$ , $Y$ , $Z$ ) to $GND_2$	-9 V to +14 V
$V_{SEL}$ to $GND_2$	-0.5 V to +7.0 V
Operating Temperature Range	$-40^\circ\text{C}$ to $+105^\circ\text{C}$
Storage Temperature Range	$-55^\circ\text{C}$ to $+150^\circ\text{C}$
Lead Temperature	
Soldering (10 sec)	260°C
Vapor Phase (60 sec)	215°C
Infrared (15 sec)	220°C

Stresses at or above those listed under Absolute Maximum Ratings may cause permanent damage to the product. This is a stress rating only; functional operation of the product at these or any other conditions above those indicated in the operational section of this specification is not implied. Operation beyond the maximum operating conditions for extended periods may affect product reliability.

### THERMAL RESISTANCE

Thermal performance is directly linked to PCB design and operating environment. Careful attention to PCB thermal design is required.

$\theta_{JA}$  is the natural convection junction to ambient thermal resistance measured in a one cubic foot sealed enclosure.

Table 9. Thermal Resistance

Package Type	$\theta_{JA}$	Unit
RN-28-1 <sup>1</sup>	43.45	$^\circ\text{C}/\text{W}$

<sup>1</sup> Thermal impedance simulated values are based on JEDEC 252P thermal test board with no bias. See JEDEC JESD-51.

Table 10. Maximum Continuous Working Voltage<sup>1,2</sup>

Parameter	Max	Unit	Reference Standard
AC Voltage			
Bipolar Waveform			
Basic Insulation	565	V peak	50-year minimum lifetime
Reinforced Insulation	565	V peak	50-year minimum lifetime
Unipolar Waveform			
Basic Insulation	1131	V peak	50-year minimum lifetime
Reinforced Insulation	1131	V peak	50-year minimum lifetime
DC Voltage			
Basic Insulation	565	V dc	50-year minimum lifetime
Reinforced Insulation	565	V dc	50-year minimum lifetime

<sup>1</sup> Refers to continuous voltage magnitude imposed across the isolation barrier. See the Insulation Lifetime section for more details.

<sup>2</sup> Values quoted for Material Group I, Pollution Degree II.

### ELECTROSTATIC DISCHARGE (ESD) RATINGS

The following ESD information is provided for handling of ESD sensitive devices in an ESD protected area only.

Human body model (HBM) per ANSI/ESDA/JEDEC JS-001.

Charged device model (CDM) per ANSI/ESDA/JEDEC JS-002.

International Electrotechnical Commission (IEC) electromagnetic compatibility: Part 4-2 (IEC) per IEC 61000-4-2.

#### ESD Ratings for ADM2561E/ADM2563E/ADM2565E/ADM2567E

Table 11. ADM2561E/ADM2563E/ADM2565E/ADM2567E, 28-Lead SOIC\_W\_FP

ESD Model	Withstand Threshold (kV)	Class
HBM	$\pm 4$	3A
CDM	$\pm 1.25$	C5
IEC <sup>1</sup>	$\pm 12$ (contact discharge) to $GND_2$	Level 4
	$\pm 15$ (air discharge) to $GND_2$	Level 4
	$\pm 8$ (across isolation barrier) to $GND_1$	Level 4 <sup>2</sup>

<sup>1</sup> Pin A, Pin B, Pin Y, and Pin Z only.

<sup>2</sup> Limited by clearance across isolation barrier.

### ESD CAUTION



**ESD (electrostatic discharge) sensitive device.** Charged devices and circuit boards can discharge without detection. Although this product features patented or proprietary protection circuitry, damage may occur on devices subjected to high energy ESD. Therefore, proper ESD precautions should be taken to avoid performance degradation or loss of functionality.

## PIN CONFIGURATIONS AND FUNCTION DESCRIPTIONS

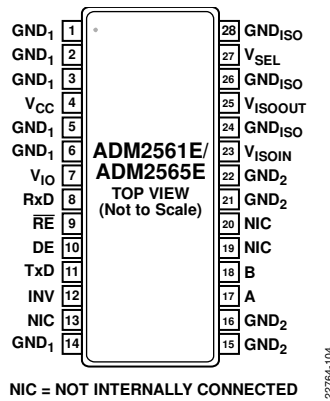

Figure 10. ADM2561E/ADM2565E Pin Configuration

Table 12. ADM2561E/ADM2565E Pin Function Descriptions

Pin No.	Mnemonic	Description
1, 2, 3, 5, 6, 14	GND <sub>1</sub>	Ground 1, Logic Side.
4	V <sub>CC</sub>	3.0 V to 3.6 V, or 4.5 V to 5.5 V Logic Side Power Supply. It is recommended that a 10 μF and a 0.1 μF decoupling capacitor be connected between V <sub>CC</sub> and GND <sub>1</sub> (Pin 1, Pin 2, and Pin 3).
7	V <sub>IO</sub>	1.7 V to 5.5 V Logic Side Flexible I/O Supply. It is recommended that a 0.1 μF decoupling capacitor be connected between V <sub>IO</sub> and GND <sub>1</sub> (Pin 5 and Pin 6).
8	RxD	Receiver Output Data. When the INV pin is logic low, this output is high when (A – B) ≥ –30 mV and low when (A – B) ≤ –200 mV. When the INV pin is high, this output is high when (A – B) ≤ 30 mV and low when (A – B) ≥ 200 mV. This output is tristated when the receiver is disabled by driving the RE pin high.
9	RE	Receiver Enable Input. This pin is an active low input. Driving this input low enables the receiver, and driving it high disables the receiver.
10	DE	Driver Output Enable. A high level on this pin enables the driver differential outputs, Y and Z. A low level places these outputs in a high impedance state.
11	TxD	Transmit Data Input. Data to be transmitted by the driver is applied to this input. When the INV pin is logic high, the data applied to this input is inverted.
12	INV	Inversion Enable. This pin is active high input. Driving this pin high inverts the TxD signal applied and inverts the A and B receiver inputs.
13, 19, 20	NIC	Not Internally Connected. This pin is not internally connected.
15, 16, 21, 22	GND <sub>2</sub>	Isolated Ground 2 for the Integrated RS-485 Transceiver, Bus Side.
17	A	Noninverting Driver Output/Receiver Input.
18	B	Inverting Driver Output/Receiver Input.
23	V <sub>ISOIN</sub>	Isolated Power Supply Input. This pin must be connected externally to V <sub>ISOOUT</sub> (Pin 25) through one BLM15HD182SN1 ferrite. It is recommended that a reservoir capacitor of 10 μF and a 0.1 μF decoupling capacitor be connected between V <sub>ISOIN</sub> (Pin 23) and GND <sub>2</sub> (Pin 21).
24, 26	GND <sub>ISO</sub>	Isolated Power Supply Ground. These pins must be connected externally to Pin 28.
25	V <sub>ISOOUT</sub>	Isolated Power Supply Output. This pin must be connected externally to V <sub>ISOIN</sub> (Pin 23) through one BLM15HD182SN1 ferrite. It is recommended that a decoupling capacitor of 0.1 μF be connected between V <sub>ISOOUT</sub> and GND <sub>ISO</sub> (Pin 28).
27	V <sub>SEL</sub>	Output Voltage Selection. When V <sub>SEL</sub> = V <sub>ISO</sub> , the V <sub>ISO</sub> set point is 5.0 V. When V <sub>SEL</sub> = GND <sub>ISO</sub> , the V <sub>ISO</sub> set point is 3.3 V.
28	GND <sub>ISO</sub>	Isolated Power Supply Ground. This pin must be connected externally to GND <sub>2</sub> (Pin 22) through one BLM15HD182SN1 ferrite.

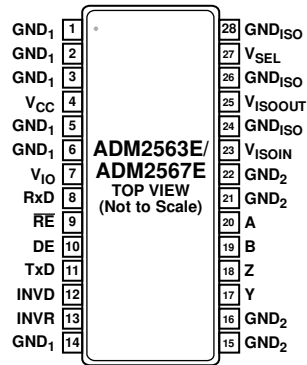

Figure 11. ADM2563E/ADM2567E Pin Configuration

Table 13. ADM2563E/ADM2567E Pin Function Descriptions

Pin No.	Mnemonic	Description
1, 2, 3, 5, 6, 14	GND <sub>1</sub>	Ground 1, Logic Side.
4	V <sub>CC</sub>	3.0 V to 3.6 V, or 4.5 V to 5.5 V Logic Side Power Supply. It is recommended that a 10 μF and a 0.1 μF decoupling capacitor be connected between V <sub>CC</sub> and GND <sub>1</sub> (Pin 1, Pin 2, and Pin 3).
7	V <sub>IO</sub>	1.7 V to 5.5 V Logic Side Flexible Input/Output (I/O) Supply. It is recommended that a 0.1 μF decoupling capacitor be connected between V <sub>IO</sub> and GND <sub>1</sub> (Pin 5 and Pin 6).
8	RxD	Receiver Output Data. When the INVR pin is logic low, this output is high when (A – B) ≥ –30 mV and low when (A – B) ≤ –200 mV. When the INVR pin is high, this output is high when (A – B) ≤ 30 mV and low when (A – B) ≥ 200 mV. This output is tristated when the receiver is disabled by driving the RE pin high.
9	RE	Receiver Enable Input. This pin is an active low input. Driving this input low enables the receiver, and driving it high disables the receiver.
10	DE	Driver Output Enable. A high level on this pin enables the driver differential outputs, Y and Z. A low level places these outputs in a high impedance state.
11	TxD	Transmit Data Input. Data to be transmitted by the driver is applied to this input. When the INVD pin is logic high, the data applied to this input is inverted.
12	INVD	Driver Inversion Enable. This pin is active high input. Driving this pin high inverts the TxD signal applied.
13	INVR	Receiver Inversion Enable. This pin is active high input. Driving this pin high inverts the A and B receiver inputs.
15, 16, 21, 22	GND <sub>2</sub>	Isolated Ground 2 for the Integrated RS-485 Transceiver, Bus Side.
17	Y	Driver Noninverting Output.
18	Z	Driver Inverting Output.
19	B	Receiver Inverting Input.
20	A	Receiver Noninverting Input.
23	V <sub>ISOIN</sub>	Isolated Power Supply Input. This pin must be connected externally to V <sub>ISOOUT</sub> (Pin 25) through one BLM15HD182SN1 ferrite. It is recommended that a reservoir capacitor of 10 μF and a 0.1 μF decoupling capacitor be connected between V <sub>ISOIN</sub> (Pin 23) and GND <sub>2</sub> (Pin 21).
24, 26	GND <sub>ISO</sub>	Isolated Power Supply Ground. These pins must be connected externally to Pin 28.
25	V <sub>ISOOUT</sub>	Isolated Power Supply Output. This pin must be connected externally to V <sub>ISOIN</sub> (Pin 23) through one BLM15HD182SN1 ferrite. It is recommended that a decoupling capacitor of 0.1 μF be connected between V <sub>ISOOUT</sub> and GND <sub>ISO</sub> (Pin 28).
27	V <sub>SEL</sub>	Output Voltage Selection. When V <sub>SEL</sub> = V <sub>ISO</sub> , the V <sub>ISO</sub> set point is 5.0 V. When V <sub>SEL</sub> = GND <sub>ISO</sub> , the V <sub>ISO</sub> set point is 3.3 V.
28	GND <sub>ISO</sub>	Isolated Power Supply Ground. This pin must be connected externally to GND <sub>2</sub> (Pin 22) through one BLM15HD182SN1 ferrite.

TYPICAL PERFORMANCE CHARACTERISTICS

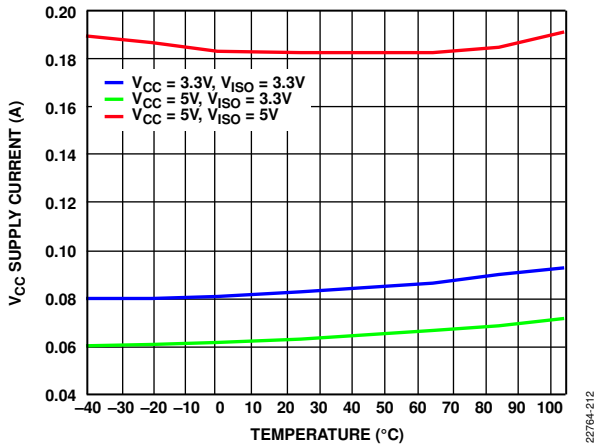

Figure 12.  $V_{CC}$  Supply Current vs. Temperature at 500 kbps, No Load, 500 kbps Models (ADM2561E and ADM2563E)

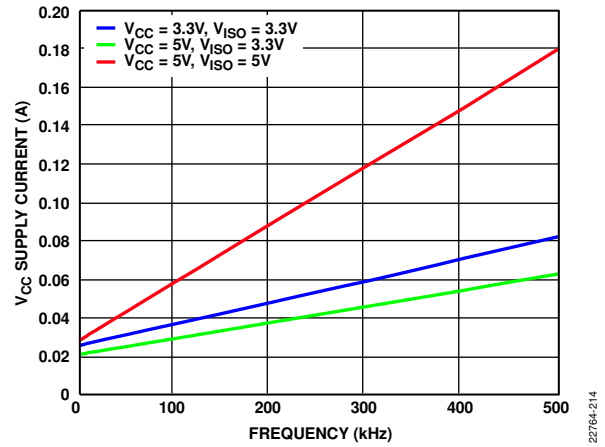

Figure 15.  $V_{CC}$  Supply Current vs. Frequency,  $T_A = 25^\circ\text{C}$ , No Load, 500 kbps Models (ADM2561E and ADM2563E)

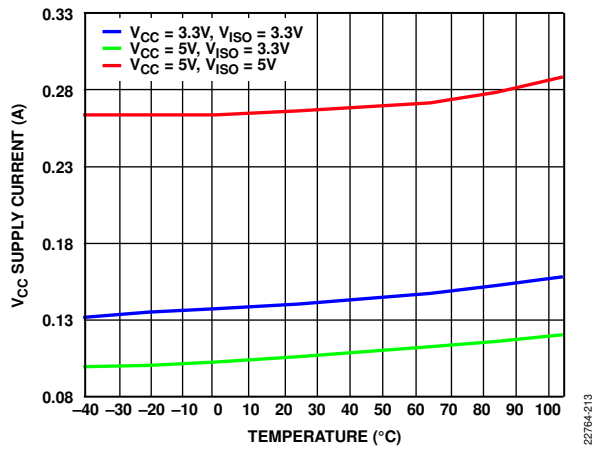

Figure 13.  $V_{CC}$  Supply Current vs. Temperature at 500 kbps, 120  $\Omega$  Load, 500 kbps Models (ADM2561E and ADM2563E)

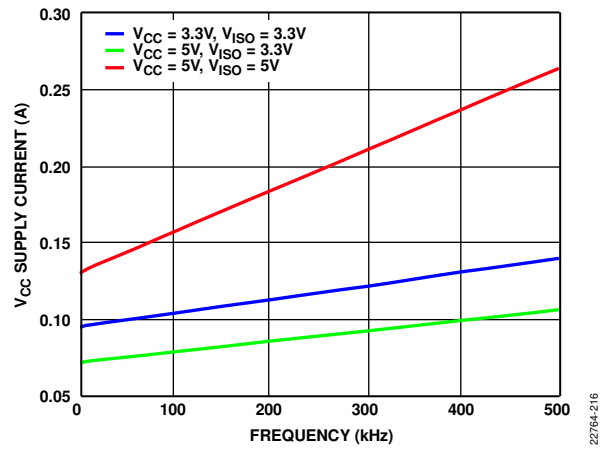

Figure 16.  $V_{CC}$  Supply Current vs. Frequency,  $T_A = 25^\circ\text{C}$ , 120  $\Omega$  Load, 500 kbps Models (ADM2561E and ADM2563E)

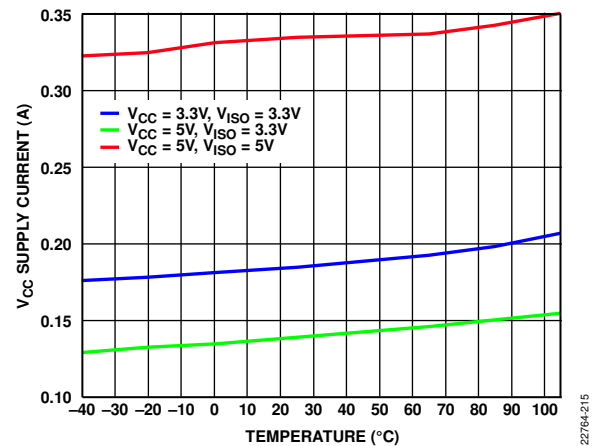

Figure 14.  $V_{CC}$  Supply Current vs. Temperature at 500 kbps, 54  $\Omega$  Load, 500 kbps Models (ADM2561E and ADM2563E)

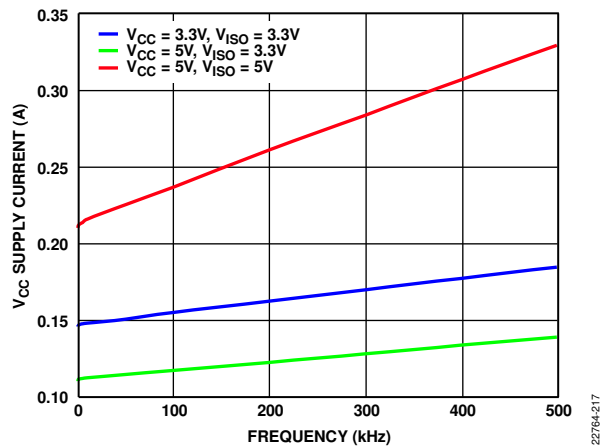

Figure 17.  $V_{CC}$  Supply Current vs. Frequency,  $T_A = 25^\circ\text{C}$ , 54  $\Omega$  Load, 500 kbps Models (ADM2561E and ADM2563E)

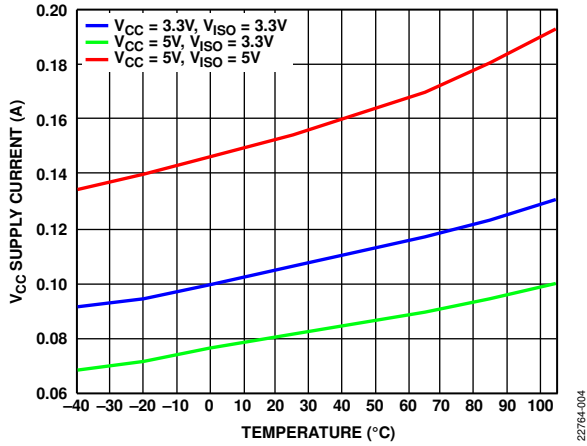

Figure 18. V<sub>CC</sub> Supply Current vs. Temperature at 25 Mbps, No Load, 25 Mbps Models (ADM2565E and ADM2567E)

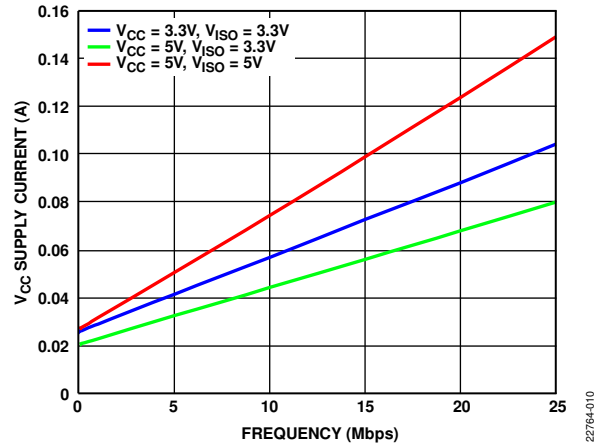

Figure 21. V<sub>CC</sub> Supply Current vs. Frequency, T<sub>A</sub> = 25°C, No Load, 25 Mbps Models (ADM2565E and ADM2567E)

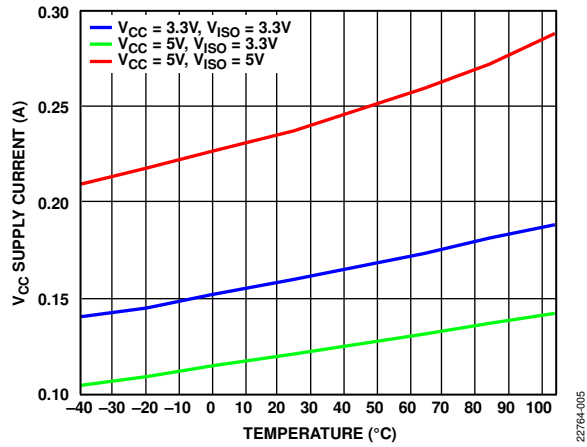

Figure 19. V<sub>CC</sub> Supply Current vs. Temperature at 25 Mbps, 120 Ω Load, 25 Mbps Models (ADM2565E and ADM2567E)

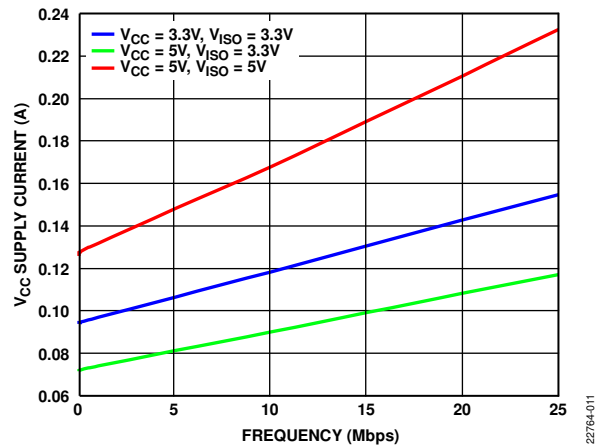

Figure 22. V<sub>CC</sub> Supply Current vs. Frequency, T<sub>A</sub> = 25°C, 120 Ω Load, 25 Mbps Models (ADM2565E and ADM2567E)

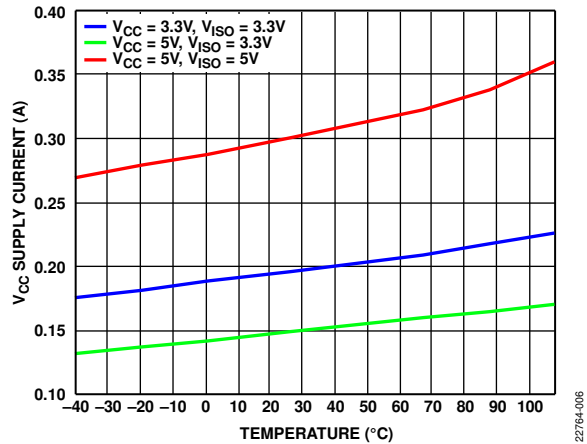

Figure 20. V<sub>CC</sub> Supply Current vs. Temperature at 25 Mbps, 54 Ω Load, 25 Mbps Models (ADM2565E and ADM2567E)

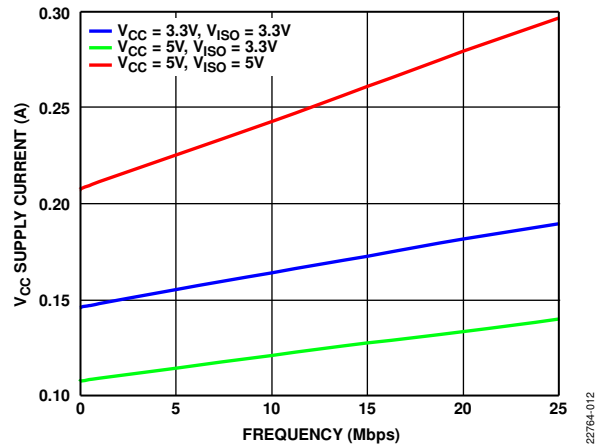

Figure 23. V<sub>CC</sub> Supply Current vs. Frequency, T<sub>A</sub> = 25°C, 54 Ω Load, 25 Mbps Models (ADM2565E and ADM2567E)

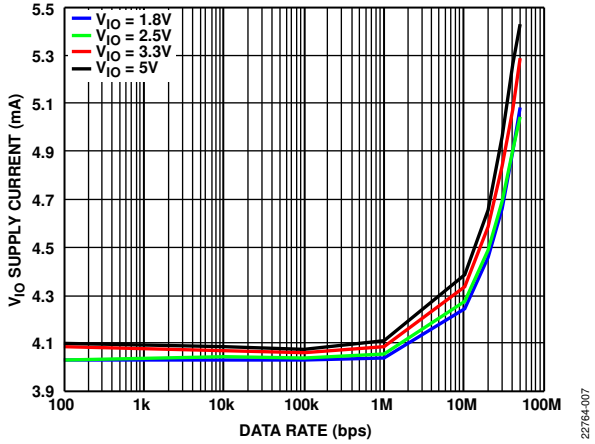

Figure 24.  $V_{IO}$  Supply Current vs. Data Rate

22764-007

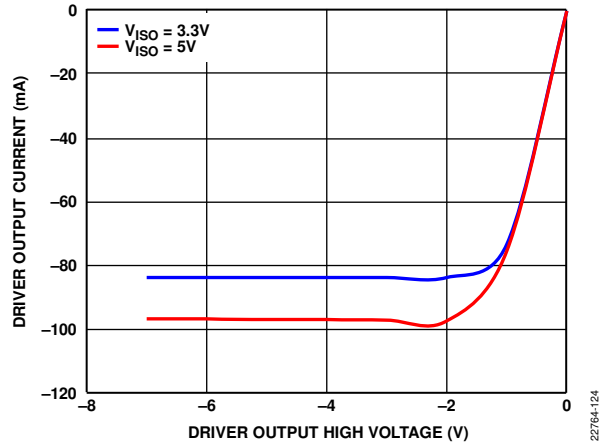

Figure 27. Driver Output Current vs. Driver Output High Voltage

22764-124

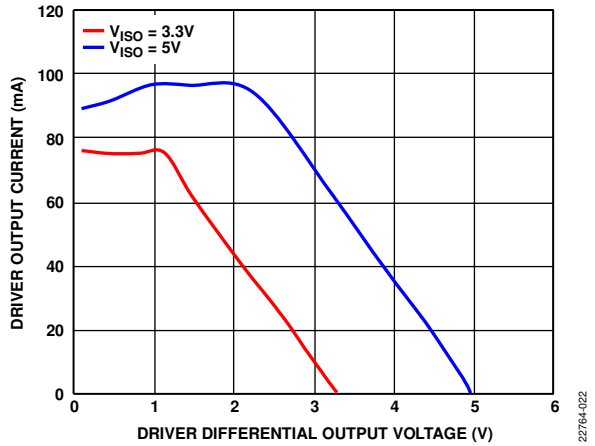

Figure 25. Driver Output Current vs. Driver Differential Output Voltage

22764-022

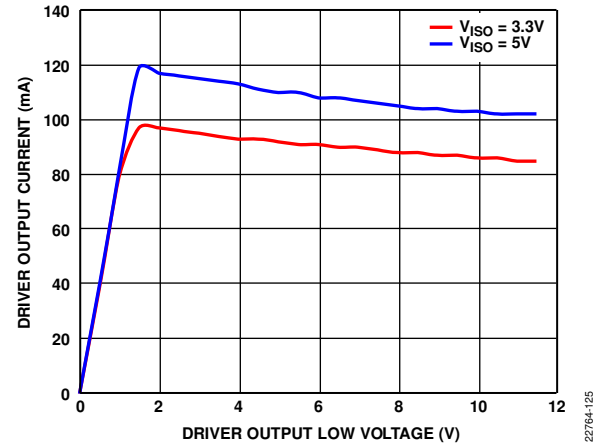

Figure 28. Driver Output Current vs. Driver Output Low Voltage

22764-125

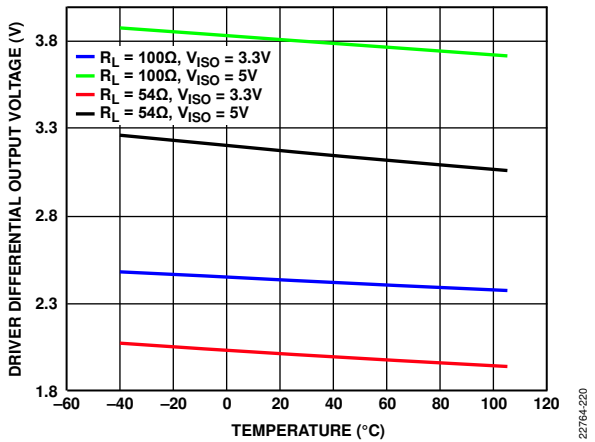

Figure 26. Driver Differential Output Voltage vs. Temperature

22764-220

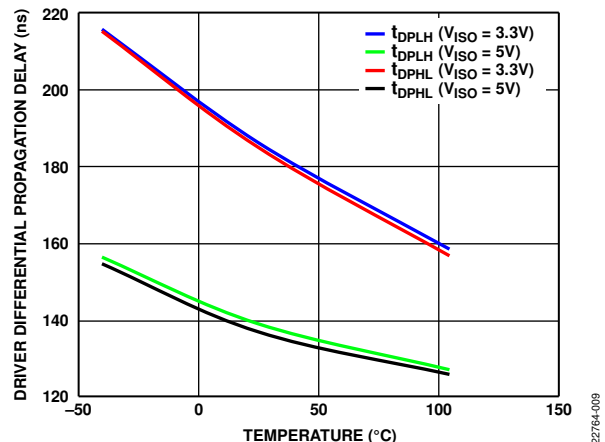

Figure 29. Driver Differential Propagation Delay vs. Temperature, 500 kbps Models (ADM2561E and ADM2563E)

22764-008



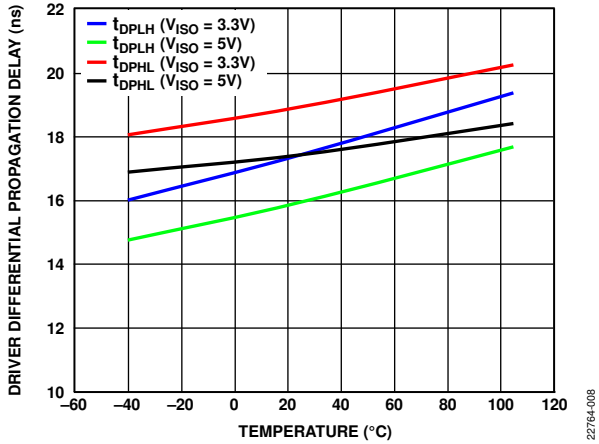

Figure 30. Driver Differential Propagation Delay vs. Temperature, 25 Mbps Models (ADM2565E and ADM2567E)

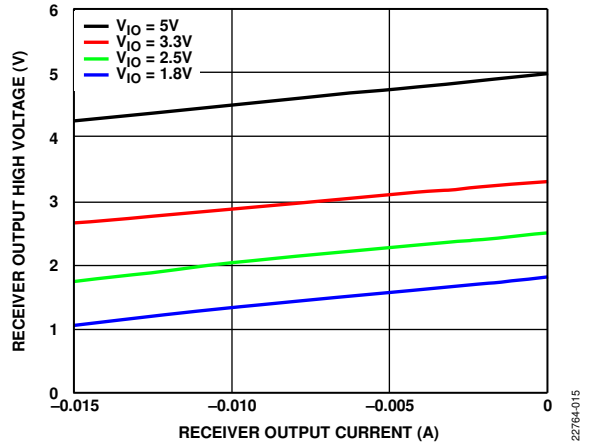

Figure 33. Receiver Output High Voltage vs. Receiver Output Current

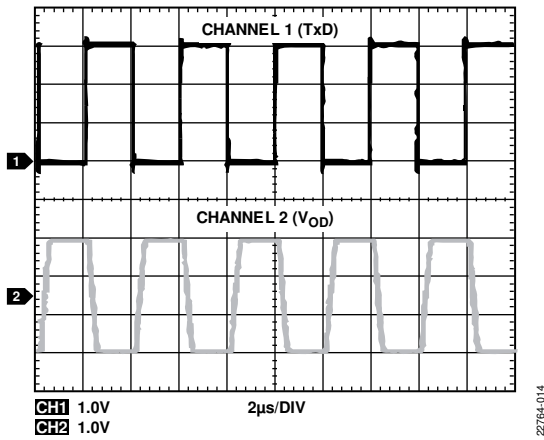

Figure 31. Transmitter Switching at 500 kbps, 500 kbps Models (ADM2561E and ADM2563E)

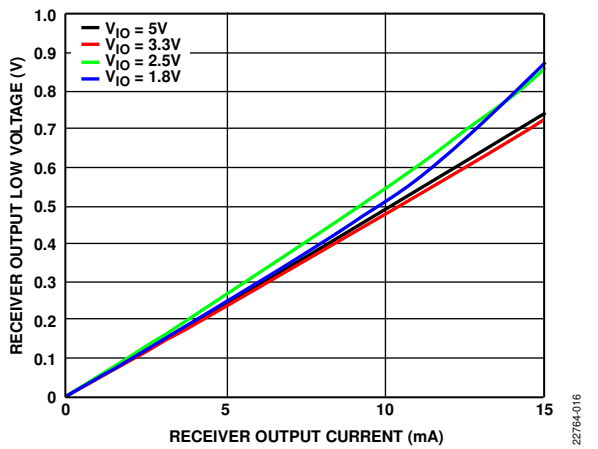

Figure 34. Receiver Output Low Voltage vs. Receiver Output Current

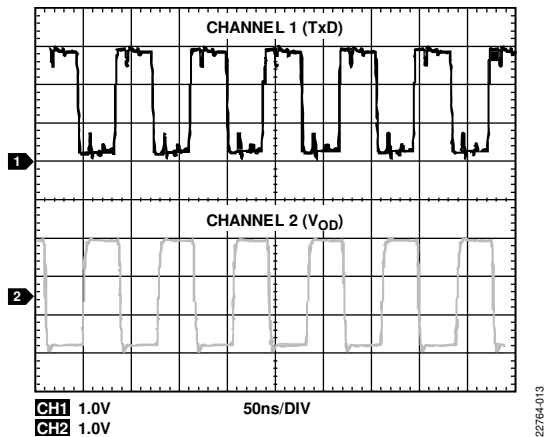

Figure 32. Transmitter Switching at 25 Mbps, 25 Mbps Models (ADM2565E and ADM2567E)

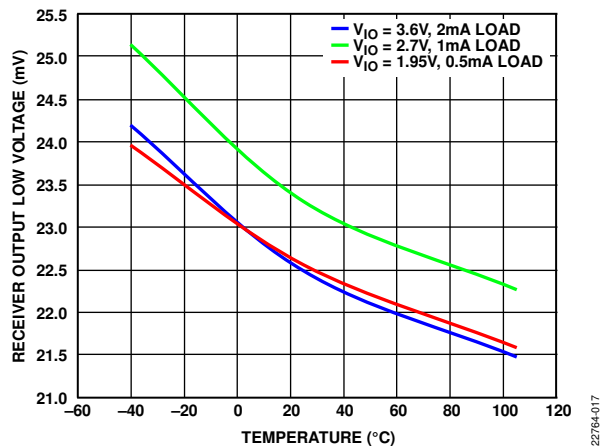

Figure 35. Receiver Output Low Voltage vs. Temperature

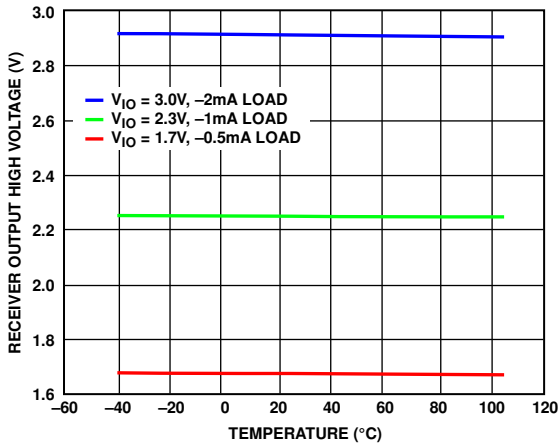

Figure 36. Receiver Output High Voltage vs. Temperature

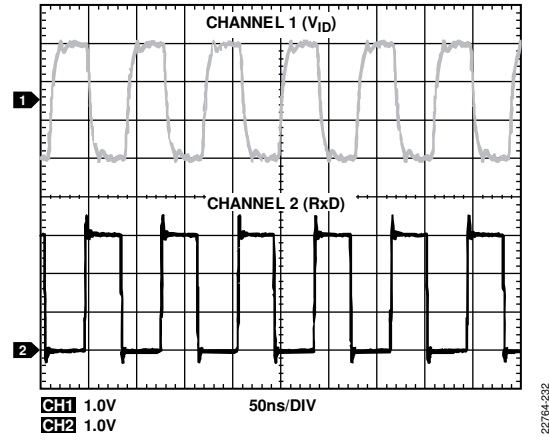

Figure 38. Receiver Switching at 25 Mbps

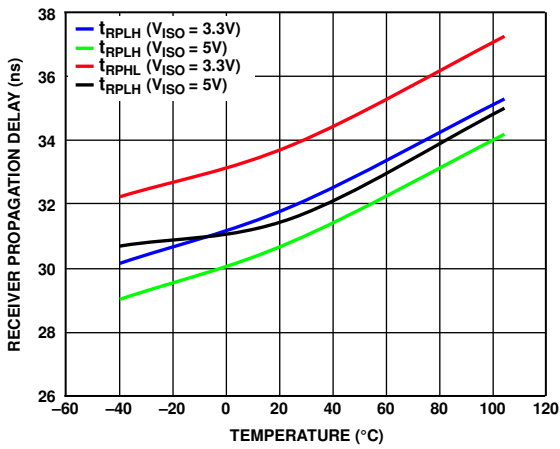

Figure 37. Receiver Propagation Delay vs. Temperature

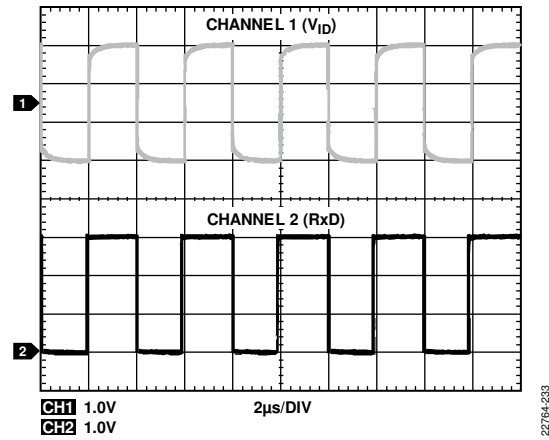

Figure 39. Receiver Switching at 500 kbps

TEST CIRCUITS

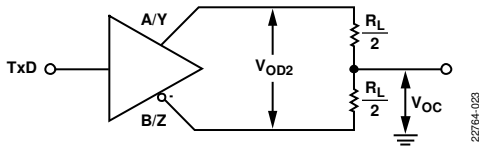

Figure 40. Driver Voltage Measurement

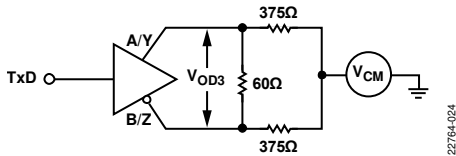

Figure 41. Driver Voltage Measurement over Common-Mode Range

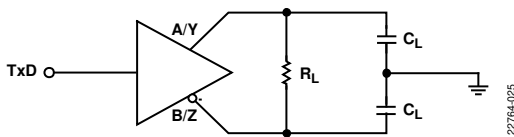

Figure 42. Driver Propagation Delay Measurement

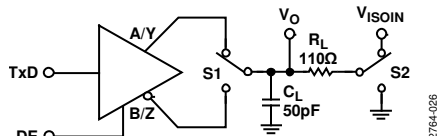

Figure 43. Driver Enable or Disable Time Measurement

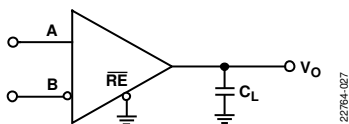

Figure 44. Receiver Propagation Delay Time Measurement

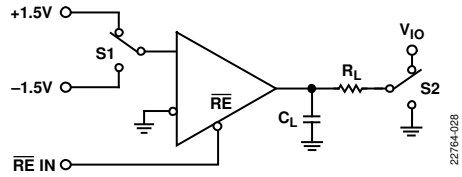

Figure 45. Receiver Enable or Disable Time Measurement

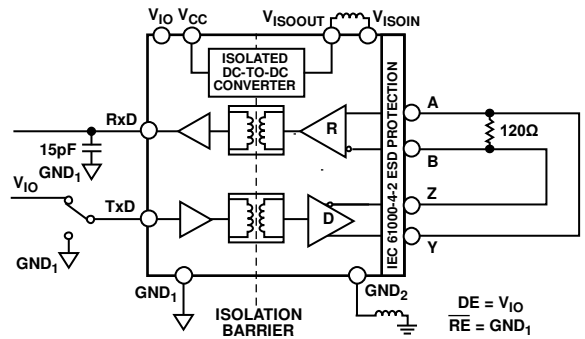

Figure 46. CMTI Test Diagram, Full Duplex

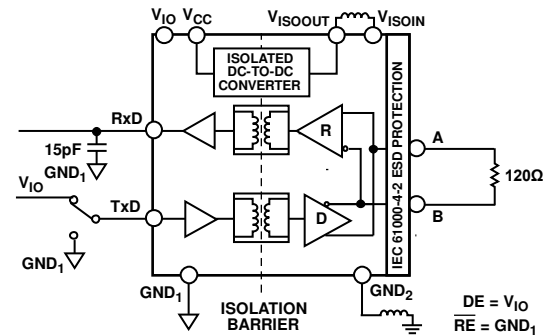

Figure 47. CMTI Test Diagram, Half Duplex

## THEORY OF OPERATION

### LOW EMI INTEGRATED DC-TO-DC CONVERTER

The ADM2561E/ADM2563E/ADM2565E/ADM2567E include a flexible integrated dc-to-dc converter optimized for low radiated emissions (EMI). The isolated dc-to-dc converter is constructed of a set of chip scale coplanar coils separated by an insulating material. By exciting the upper coil with an ac signal, power is magnetically coupled across the isolation barrier where it is rectified and regulated. Because no direct electrical connection exists between the top and bottom coil, the primary and secondary side of the device remain galvanically isolated.

This isolated dc-to-dc converter features a regulated output of either 3.3 V or 5 V, selectable via the  $V_{SEL}$  logic pin, which allows the user to optimize the supply rail of the RS-485 transceiver. For lower power applications, a 3.3 V supply can be chosen. For applications requiring a large differential output voltage, such as PROFIBUS®, the isolated dc-to-dc converter can be operated with a 5 V output. Table 14 shows the supported supply configurations for the isolated dc-to-dc converter.

Table 14. Isolated DC-to-DC Converter Supply Configuration

$V_{SEL}$ Pin	$V_{ISO}$ Output Supply Voltage	Supported $V_{CC}$ Supply Range
Connected to $GND_{ISO}$	3.3 V	3 V to 5.5 V
Connected to $V_{ISOOUT}$	5 V	4.5 V to 5.5 V

The integrated dc-to-dc converter is optimized to minimize radiated EMI, and allows designers to meet the CISPR32 and EN 55032 Class B requirements on a 2-layer PCB with the addition of two low cost, surface-mount device (SMD) ferrites. Follow layout recommendations during PCB design to minimize these emissions. See the PCB Layout and Electromagnetic Interference (EMI) section for more details.

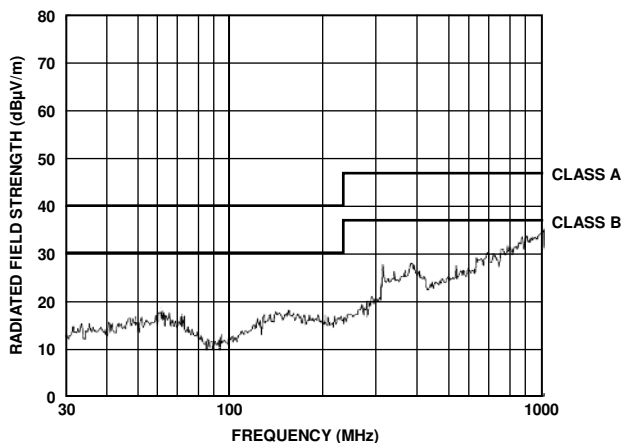

Figure 48. Low Radiated Emissions DC-to-DC Converter Meets EN55022 Class B with Margin on a 2-Layer PCB

### ROBUST LOW POWER DIGITAL ISOLATOR

The ADM2561E/ADM2563E/ADM2565E/ADM2567E feature a low power digital isolator to galvanically isolate the primary and secondary side of the device. The use of coplanar transformer coils with an on and off keying modulation scheme allows high data throughput across the isolation barrier while minimizing radiation emissions. This architecture provides a robust digital isolator with immunity to common-mode transients of greater than 250 kV/µs across the full temperature and supply range of the device.

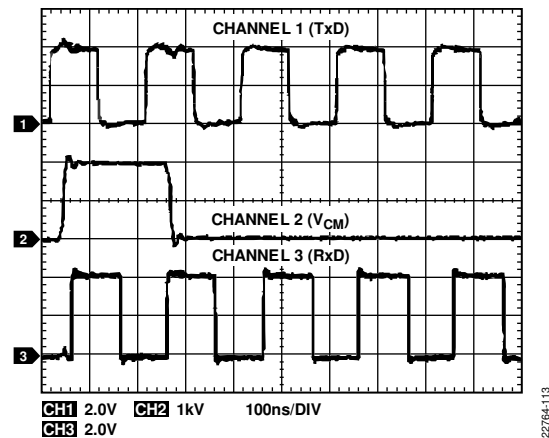

Figure 49. Switching Correctly in the Presence of >250 kV/µs Common-Mode Transients

### HIGH DRIVER DIFFERENTIAL OUTPUT VOLTAGE

The ADM2561E/ADM2563E/ADM2565E/ADM2567E feature a proprietary transmitter architecture with a low driver output impedance, resulting in an increased driver differential output voltage. This architecture is particularly useful when operating the device over long cable runs, where the dc resistance of the transmission line dominates signal attenuation. In these applications, the increased differential voltage improves noise margin and allows transmission over longer cable lengths. In addition, when operated as a 5 V transceiver ( $V_{SEL} = V_{ISO}$ ), the ADM2561E/ADM2563E/ADM2565E/ADM2567E meet or exceed the PROFIBUS requirement of a minimum 2.1 V differential output voltage.

### IEC61000-4-2 ESD PROTECTION

ESD is the sudden transfer of electrostatic charge between bodies at different potentials caused by near contact or induced by an electric field. ESD has the characteristics of high current in a short time period. The primary purpose of the IEC 61000-4-2 test is to determine the immunity of systems to external ESD events outside the system during operation. IEC 61000-4-2 describes testing using two coupling methods: contact discharge and air discharge. Contact discharge implies a direct contact between the discharge gun and the equipment under test (EUT). During air discharge testing, the charged electrode of the discharge gun is moved toward the EUT until a discharge occurs as an arc across the air gap. The discharge gun does not

make direct contact with the EUT. A number of factors affect the results and repeatability of the air discharge test, including humidity, temperature, barometric pressure, distance, and rate of approach to the EUT. Air discharge testing is a more accurate representation of an actual ESD event than contact discharge but is not as repeatable. Therefore, contact discharge is the preferred test method. During testing, the data port is subjected to at least 10 positive and 10 negative single discharges. Selection of the test voltage is dependent on the system end environment. Figure 50 shows the 8 kV contact discharge current waveform as described in the IEC 61000-4-2 specification. Some of the key waveform parameters are rise times of less than 1 ns and pulse widths of approximately 60 ns.

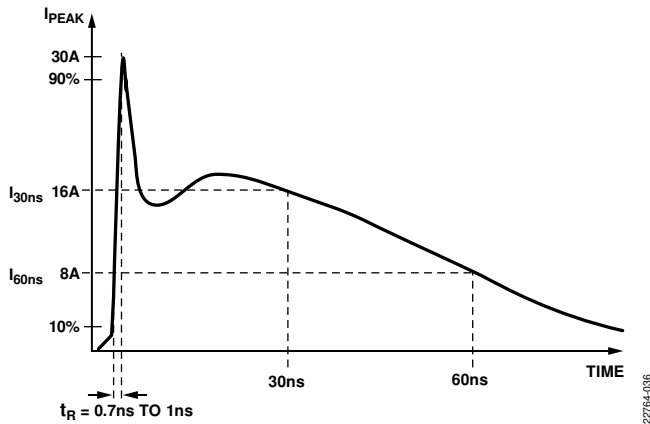

Figure 50. IEC61000-4-2 ESD Waveform (8 kV)

Figure 51 shows the 8 kV contact discharge current waveform from the IEC 61000-4-2 standard compared to the HBM ESD 8 kV waveform. Figure 51 shows that the two standards specify a different waveform shape and peak current ( $I_{PEAK}$ ). The peak current associated with an IEC 61000-4-2 8 kV pulse is 30 A, whereas the corresponding peak current for HBM ESD is more than five times less, at 5.33 A. The other difference is the rise time of the initial voltage spike, with the IEC 61000-4-2 ESD waveform having a much faster rise time of 1 ns, compared to the 10 ns associated with the HBM ESD waveform. The amount of power associated with an IEC ESD waveform is much greater than that of an HBM ESD waveform. The HBM ESD standard requires the EUT to be subjected to three positive and three negative discharges, whereas in comparison, the IEC ESD standard requires 10 positive and 10 negative discharge tests.

The ADM2561E/ADM2563E/ADM2565E/ADM2567E are rated to  $\pm 12$  kV contact and  $\pm 15$  kV air ESD protection to the IEC61000-4-2 standard between the RS-485 bus pins (A, B, Y and Z) and  $GND_2$ . The isolation barrier provides  $\pm 8$  kV contact protection between the bus pins and  $GND_1$ . These devices with IEC 61000-4-2 ESD ratings are better suited for operation in harsh environments when compared to other RS-485 transceivers that state varying levels of HBM ESD protection.

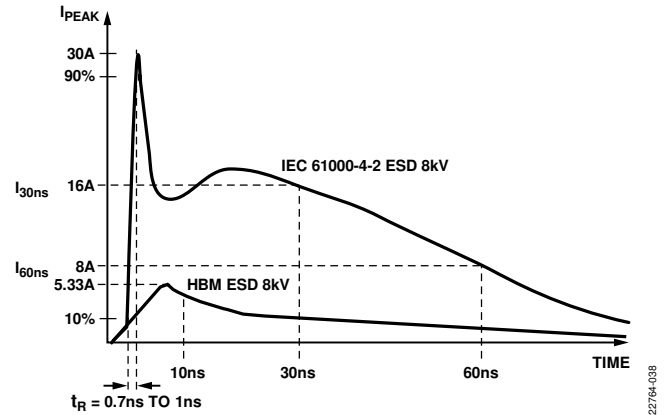

Figure 51. IEC61000-4-2 ESD 8 kV Waveform Compared to HBM ESD 8 kV Waveform

**TRUTH TABLES**

Table 16 and Table 17 use the abbreviations shown in Table 15.  $V_{IO}$  supplies the DE, TxD,  $\overline{RE}$ , RxD, INVR, and INVD pins only.

Table 15. Truth Table Abbreviations

Letter	Description
H	High level
I	Indeterminate
L	Low level
X	Any state
Z	High impedance (off)

Table 16. Transmitting Truth Table

Supply Status		Inputs			Outputs	
$V_{CC}$	$V_{IO}$	DE	TxD	INVD	Y	Z
On	On	H	H	L	H	L
On	On	H	H	H	L	H
On	On	H	L	L	L	H
On	On	H	L	H	H	L
On	On	L	X	X	Z	Z
On	Off	X	X	X	Z	Z
Off	X	X	X	X	Z	Z

Table 17. Receiving Truth Table

Supply Status		Inputs			Output
$V_{CC}$	$V_{IO}$	A – B	INVR	$\overline{RE}$	RxD
On	On	$\geq -0.03$ V	L	L	H
On	On	$\leq 0.03$ V	H	L	H
On	On	$\leq -0.2$ V	L	L	L
On	On	$\geq 0.2$ V	H	L	L
On	On	$-0.2$ V < A – B < $-0.03$ V	L	L	I
On	On	$0.03$ V < A – B < $0.2$ V	H	L	I
On	On	Inputs open/shorted	X	L	H
X	On	X	X	H	Z
X	Off	X	X	X	I
Off	On	X	X	L	I

**RECEIVER FAIL-SAFE**

The ADM2561E/ADM2563E/ADM2565E/ADM2567E guarantee a logic high receiver output when the receiver inputs are shorted, open, or connected to a terminated transmission line with all drivers disabled. When the receiver inversion feature is disabled (INV/INVR = 0 V), a fail-safe logic high output is achieved by setting the receiver input threshold between -30 mV and -200 mV. If the differential receiver input voltage (A - B) is greater than or equal to -30 mV, the RxD pin is logic high. If the A - B input is less than or equal to -200 mV, RxD is logic low. Fail-safe is preserved when the receiver inversion feature is enabled (INVR = V<sub>IO</sub>) by setting the inverted receiver input threshold between 30 mV and 200 mV. In the case of a shorted or terminated bus with all transmitters disabled, the receiver differential input voltage is pulled to 0 V by the termination resistor, resulting in a logic high with a 30 mV minimum noise margin. This feature eliminates the need for external biasing components usually required to implement fail-safe.

These features are fully compatible with external fail-safe biasing configurations, which can be used in applications with legacy devices that lack fail-safe support, or in applications where additional noise margin is desired. See the [AN-960 Application Note, RS-485/RS-422 Circuit Implementation Guide](#), for details on external fail-safe biasing.

**DRIVER AND RECEIVER CABLE INVERSION**

The ADM2561E/ADM2563E/ADM2565E/ADM2567E feature cable inversion functionality to correct errors during installation. This adjustment can be implemented in software on the controller driving the RS485 transceiver and helps avoid additional installation costs to fix wiring errors. The ADM2563E/ADM2567E feature separate digital logic pins, INVD and INVR, to correct cases where the driver, receiver, or both are wired in reverse. Use the INVD pin to correct driver functionality when Y and Z are wired with the incorrect polarity. Use the INVR

pin to correct receiver functionality when A and B are wired with the incorrect polarity. The ADM2561E/ADM2565E are half-duplex devices that have a single inversion pin, INV, to correct both transmitter and receiver polarity. When the receiver is inverted, the device maintains a Logic 1 receiver output with a 30 mV noise margin when inputs are shorted together or open circuit. Figure 52 shows the receiver output in both inverted and noninverted cases.

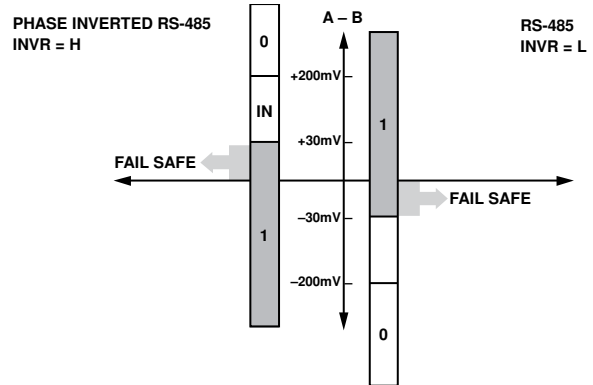

Figure 52. RS-485 and Phase Inverted RS-485 Comparison

**HOT SWAP INPUTS**

When a circuit board is inserted in a powered (or hot) backplane, parasitic coupling from supply and ground rails to digital inputs may occur. The ADM2561E/ADM2563E/ADM2565E/ADM2567E contain circuitry to ensure that the Y and Z outputs remain in a high impedance state during power-up, and then default to the correct states. For example, when V<sub>IO</sub> and V<sub>CC</sub> power up at the same time and the RE pin is pulled low, with the DE and TxD pins pulled high, the Y and Z outputs remain in high impedance until settling at an expected default high state for the Y pin and expected default low state for the Z pin.

Table 18. Product Description Table

Device	Isolation Withstand	Duplex	Maximum Data Rate	Cable Inversion Feature	Package(s) Available
ADM2561E	3 kV	Half	500 kbps <sup>1</sup>	Inversion pin (INV)	28-lead SOIC_W with finer pitch
ADM2563E	3 kV	Full	500 kbps <sup>1</sup>	Separate driver (INVD) and receiver (INVR) inversion	28-lead SOIC_W with finer pitch
ADM2565E	3 kV	Half	25 Mbps	Inversion pin (INV)	28-lead SOIC_W with finer pitch
ADM2567E	3 kV	Full	25 Mbps	Separate driver (INVD) and receiver (INVR) inversion	28-lead SOIC_W with finer pitch

<sup>1</sup> Driver outputs are slew rate limited to minimize common-mode emissions over long cable runs.

### 192 TRANSCEIVERS ON THE BUS

The standard RS-485 receiver input impedance is 12 k $\Omega$  (1 unit load), and the standard driver can drive up to 32 unit loads. The ADM2561E/ADM2563E/ADM2565E/ADM2567E transceiver has a 1/6 unit load receiver input resistance (equivalent to 72 k $\Omega$ ), allowing up to 192 transceivers to be connected in parallel on one communication line. Any combination of these devices and other RS-485 transceivers with a total of 32 unit loads or fewer can be connected to the line.

### DRIVER OUTPUT PROTECTION

The ADM2561E/ADM2563E/ADM2565E/ADM2567E feature two methods to prevent excessive output current and power dissipation caused by faults or by bus contention. Current-limit protection on the output stage provides immediate protection against short circuits over the entire common-mode voltage range. In addition, a thermal shutdown circuit forces the driver outputs to a high impedance state if the die temperature rises excessively. This circuitry is designed to disable the driver outputs when a die temperature greater than 150°C is reached. As the device cools, the drivers are reenabled at a temperature of 140°C.

### 1.7 V TO 5.5 V V<sub>IO</sub> LOGIC SUPPLY

The ADM2561E/ADM2563E/ADM2565E/ADM2567E feature a V<sub>IO</sub> logic supply pin to allow a flexible digital interface operational to voltages as low as 1.7 V. The V<sub>IO</sub> pin powers the primary side of the signal isolation, the logic inputs, and the RxD output. These input and output pins interface with logic devices such as universal asynchronous receiver/transmitters (UARTs), application specific integrated circuits (ASICs), and microcontrollers. For applications where these devices use I/Os operating at voltages other than the ADM2561E/ADM2563E/ADM2565E/ADM2567E V<sub>CC</sub> supply voltage, the V<sub>IO</sub> supply can be powered from the same supply rail as the logic device. The V<sub>IO</sub> supply accepts a supply voltage between 1.7 V and 5.5 V, allowing communication with 1.8 V, 2.5 V, 3.3 V, and 5 V devices.

## APPLICATIONS INFORMATION

### PCB LAYOUT AND ELECTROMAGNETIC INTERFERENCE (EMI)

The ADM2561E/ADM2563E/ADM2565E/ADM2567E meet EN 55032 Class B/CISPR32 radiated emissions requirements. Two external surface-mount technology (SMT) ferrite beads are used to pass the Class B limits with margin. No additional mitigation techniques, such as stitching capacitance, are needed, allowing system designers to create a compliant design on a 2-layer PCB, without the need for complex and area intensive layouts.

The ADM2561E/ADM2563E/ADM2565E/ADM2567E feature an internal split paddle lead frame on the bus side. For optimal noise suppression, filter the  $V_{ISOOUT}$  signal (Pin 25) and  $GND_{ISO}$  signal (Pin 24, Pin 26, and Pin 28) for high frequency currents before routing power to the RS-485 transceiver and other circuitry. Two SMT ferrite beads, L1 and L2, are recommended to achieve this filtering. The size of the  $V_{ISOOUT}$  and  $GND_{ISO}$  net must also be kept to a minimum. See Figure 53 for the recommended PCB layout.

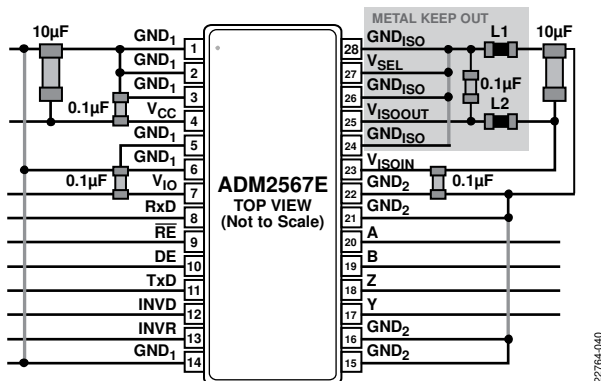

Figure 53. Recommended PCB Layout

The *isoPower*® integrated dc-to-dc converter contains switching frequencies between 180 MHz and 400 MHz. To effectively filter these frequencies, the impedance of the ferrite bead is chosen to be about 2 kΩ between the 100 MHz and 1 GHz frequency range. Some recommended SMT ferrites are shown in Table 19. Although these ferrite beads are required to achieve compliance to EN 55032 Class B, they are not needed for system functionality. The ADM2561E/ADM2563E/ADM2565E/ADM2567E have been fully characterized with the recommended BLM15HD182SN1 ferrite beads.

Table 19. Examples of Surface-Mount Ferrite Beads

Manufacturer	Device No.
Murata Electronics	BLM15HD182SN1
Taiyo Yuden	BKH1005LM182-T

The ADM2561E/ADM2563E/ADM2565E/ADM2567E can dissipate over 500 mW of power when fully loaded. Because it is not possible to apply a heat sink to an isolation device, the devices primarily depend on heat dissipation to the PCB through the  $GND_x$  pins. If the devices are used at high ambient temperatures, provide a thermal path from the  $GND_x$  pins to the PCB ground plane. The use of a solid  $GND_1$  and  $GND_2$  plane is recommended. Implementing a low thermal impedance between the top ground layers and internal ground layers reduce the temperature inside the chip significantly.

### DEVICE POWER-UP

The integrated *isoPower* isolated dc-to-dc converter requires 10 ms to power up to the setpoint of 3.3 V or 5 V. During this start-up time, it is not recommended to assert the DE driver enable signal.

In applications where the isolated dc-to-dc converter is operated with a 3.3 V output voltage ( $V_{SEL}$  pin connected to  $GND_{ISO}$ ), the  $V_{CC}$  supply rail must be greater than 3.135 V during the power-up sequence. After the 10 ms power-up duration, the  $V_{CC}$  supply rail can operate across the full 3 V to 5.5 V range.

### MAXIMUM DATA RATE vs. AMBIENT TEMPERATURE

Under a large current load or when operating at high frequency operation, self heating effects within the *isoPower* dc-to-dc converter can limit the maximum ambient temperature achievable while retaining a silicon junction temperature below 150°C. This internal power dissipation is related to application conditions such as supply voltage configuration, switching frequency, effective load on the RS-485 bus, and the amount of time the transceiver is in transmit mode. Thermal performance also depends on the PCB design and thermal characteristics of a system.

In applications with a fully loaded RS-485 bus (equivalent to 54 Ω bus resistance) operating with  $V_{ISO} = 5$  V, it is recommended to keep the  $V_{CC}$  input supply greater than 4.75 V. If this is not possible for the ADM2565E/ADM2567E, limit either the maximum ambient temperature to 85°C or the maximum operating data rate to 6 Mbps. If this is not possible for the ADM2561E/ADM2563E, limit the maximum ambient temperature to 85°C.



### ISOLATED PROFIBUS SOLUTION

The ADM2565E features a driver that is well suited for meeting the requirements of an isolated PROFIBUS node. When operating the ADM2565E as a PROFIBUS transceiver, connect the  $V_{SEL}$  pin to the  $V_{ISOOUT}$  pin to operate the transceiver with a 5 V isolated supply voltage. The ADM2565E features the following characteristics that make it ideally suited for use in PROFIBUS applications:

- 5 V isolated transceiver power supply. The 5 V  $V_{ISO}$  output supply provides the required current for the RS-485 transceiver at up to 12 Mbps and the additional 5 mA required for the PROFIBUS termination network.
- The output driver meets or exceeds the PROFIBUS differential output requirements. To ensure the transmitter differential output does not exceed 7 V p-p over all conditions, place 10  $\Omega$  resistors in series with the A and B transmitter outputs.
- High speed timing to operate at 12 Mbps with low propagation delay and less than 10% transmitter and receiver skew.
- Low bus pin capacitance of 28 pF.
- Class I (no loss of data) immunity to IEC 61000-4-4 EFT to  $\pm 1$  kV can be achieved using a PROFIBUS shielded cable. At data rates of  $\leq 500$  kbps, IEC 61000-4-4 Class I to  $\pm 3$  kV can be achieved with the addition of a 470 pF capacitor to  $GND_1$  on the Rx/D output pin.

### EMC, EFT, AND SURGE

In applications where additional levels of protection against IEC61000-4-4 EFT or IEC61000-4-5 surge events are required, external protection circuits can be added to further enhance the EMC robustness of these devices. See Figure 54 for a recommended protection circuit, which uses a series of SM712 transient voltage suppressor (TVS) and 10  $\Omega$  pulse proof resistors to achieve in excess of Level 4 IEC61000-4-2 ESD and IEC61000-4-4 EFT protection, and Level 2 IEC61000-4-5 surge protection. Table 20 and Table 21 describe the recommended components for protection and the protection levels.

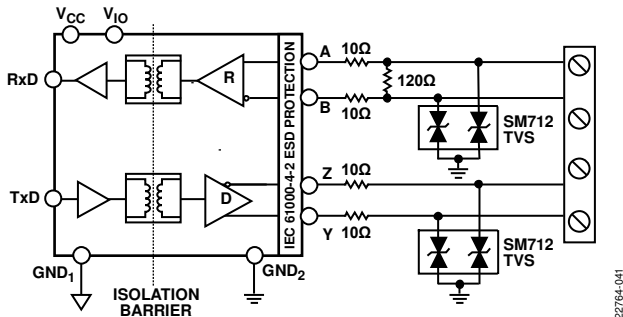

Figure 54. Isolated RS-485 Solution with ESD, EFT, and Surge Protection

Table 20. Recommended Components for ESD, EFT, and Surge Protection

Recommended Components	Part Number
TVS	CDSOT23-SM712
10 $\Omega$ Pulse Proof Resistors	CRCW060310R0FKEAHP

Table 21. Protection Levels with Recommended Circuit

EMC Standard	Protection Level (kV)
ESD—Contact (IEC61000-4-2)	$\geq \pm 30$ (exceeds Level 4)
ESD—Air (IEC61000-4-2)	$\geq \pm 30$ (exceeds Level 4)
EFT (IEC61000-4-4)	$\geq \pm 4$ (exceeds Level 4)
Surge (IEC61000-4-5)	$\geq \pm 1$ (Level 2)

### INSULATION LIFETIME

All insulation structures eventually break down when subjected to voltage stress over a sufficiently long period of time. The rate of insulation degradation is dependent on the characteristics of the voltage waveform applied across the insulation, as well as on the materials and material interfaces.

The two types of insulation degradation of primary interest are breakdown along surfaces exposed to the air and insulation wear out. Surface breakdown is the phenomenon of surface tracking and is the primary determinant of surface creepage requirements in system level standards. Insulation wear out is the phenomenon where charge injection or displacement currents inside the insulation material cause long-term insulation degradation.

#### Surface Tracking

Surface tracking is addressed in electrical safety standards by setting a minimum surface creepage based on the working voltage, the environmental conditions, and the properties of the insulation material. Safety agencies perform characterization testing on the surface insulation of components, allowing the components to be categorized in different material groups. Lower material group ratings are more resistant to surface tracking and can therefore provide adequate lifetime with smaller creepage. The minimum creepage for a given working voltage and material group is in each system level standard and is based on the total rms voltage across the isolation, pollution degree, and material group. See Table 6 for the material group and creepage information for the ADM2561E/ADM2563E/ADM2565E/ADM2567E isolated RS-485 transceiver.

#### Insulation Wear Out

The lifetime of insulation caused by wear out is determined by the thickness, material properties, and the voltage stress applied across the insulation. It is important to verify that the product lifetime is adequate at the application working voltage. The working voltage supported by an isolator for wear out may not be the same as the working voltage supported for tracking. The working voltage applicable to tracking is specified in most standards.

Testing and modeling show that the primary driver of long-term degradation is displacement current in the polyimide insulation, causing incremental damage. The stress on the insulation can be divided into broad categories, such as dc stress and ac component time varying voltage stress. DC stress causes little wear out because there is no displacement current, whereas ac component time varying voltage stress causes wear out.

The ratings in certification documents are typically based on 60 Hz sinusoidal stress to reflect isolation from the line voltage. However, many practical applications have combinations of 60 Hz ac and dc across the barrier, as shown in Equation 1. Because only the ac portion of the stress causes wear out, the equation can be rearranged to solve for the ac rms voltage, as shown in Equation 2. For insulation wear out with the polyimide materials used in these products, the ac rms voltage determines the product lifetime.

$$V_{RMS} = \sqrt{V_{AC\ RMS}^2 + V_{DC}^2} \tag{1}$$

or

$$V_{AC\ RMS} = \sqrt{V_{RMS}^2 - V_{DC}^2} \tag{2}$$

where:

$V_{RMS}$  is the total rms working voltage.

$V_{AC\ RMS}$  is the time varying portion of the working voltage.

$V_{DC}$  is the dc offset of the working voltage.

**Calculation and Use of Parameters Example**

The following example frequently arises in power conversion applications. Assume that the line voltage on one side of the isolation is 240 V ac rms and a 400 V dc bus voltage is present on the other side of the isolation barrier. The isolator material is polyimide. To establish the critical voltages in determining the creepage, clearance, and lifetime of a device, see Figure 55 and the following equations.

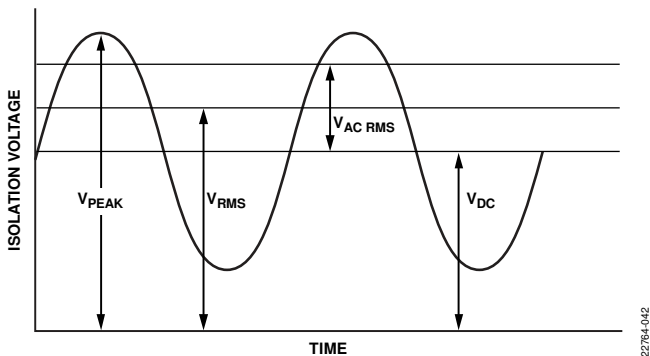

Figure 55. Critical Voltage Example

The working voltage across the barrier from Equation 1 is

$$V_{RMS} = \sqrt{V_{AC\ RMS}^2 + V_{DC}^2}$$

$$V_{RMS} = \sqrt{240^2 + 400^2}$$

$$V_{RMS} = 466\text{ V}$$

This  $V_{RMS}$  value is the working voltage used together with the material group and pollution degree when determining the creepage required by a system standard.

To determine if the lifetime is adequate, obtain the time varying portion of the working voltage. To obtain the ac rms voltage, use Equation 2.

$$V_{AC\ RMS} = \sqrt{V_{RMS}^2 - V_{DC}^2}$$

$$V_{AC\ RMS} = \sqrt{466^2 - 400^2}$$

$$V_{AC\ RMS} = 240\text{ V rms}$$

In this case, the ac rms voltage is simply the line voltage of 240 V rms. This calculation is more relevant when the waveform is not sinusoidal. The value is compared to the limits for working voltage in Table 10 for the expected lifetime, which is less than a 60 Hz sine wave, and it is well within the limit for a 50-year service life.

The dc working voltage limit is set by the creepage of the package as specified in IEC 60664-1. This value can differ for specific system level standards.

**TYPICAL APPLICATIONS**

An example circuit using the ADM2567E as a full duplex RS-485 node is shown in Figure 56. Placement of the termination resistor,  $R_T$ , is dependent on the location of the node and the network topology. Refer to the [AN-960 Application Note, RS-485/RS-422 Circuit Implementation Guide](#), for guidance on termination. Up to 192 transceivers can be connected to the bus. To minimize reflections, terminate the line at the receiving end in its characteristic impedance and keep stub lengths off the main line as short as possible. For half-duplex operation, this means that both ends of the line must be terminated because either end can be the receiving end.

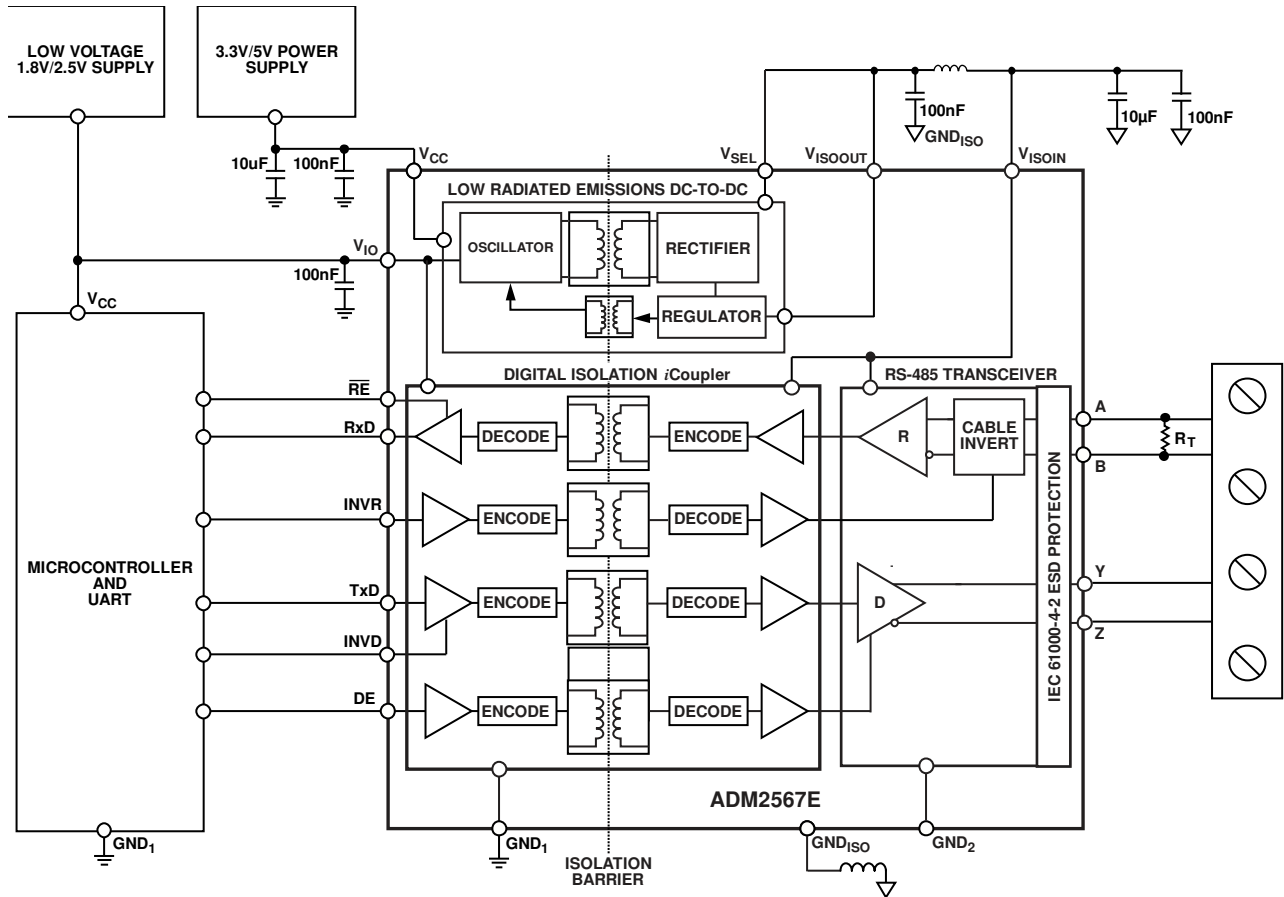

Figure 56. Example Circuit Diagram Using the ADM2567E

22764-043

OUTLINE DIMENSIONS

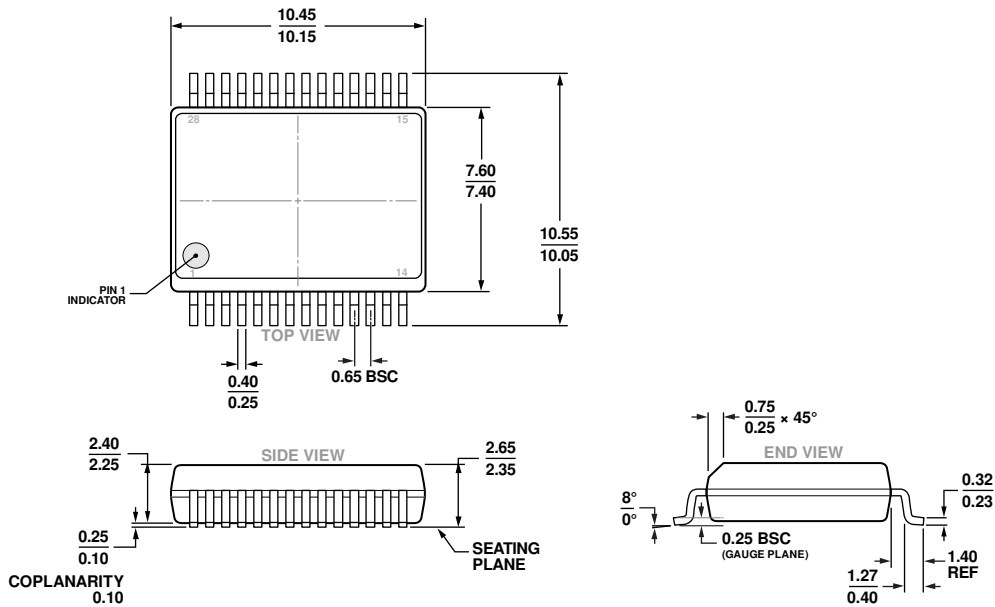

Figure 57. 28-Lead Standard Small Outline, Wide Body, with Finer Pitch [SOIC\_W\_FP] (RN-28-1)

Dimensions shown in millimeters

ORDERING GUIDE

Model <sup>1</sup>	Isolation (kV)	Data Rate (Mbps)	Duplex	Temperature Range	Package Description	Package Option
ADM2561EBRNZ	3	0.5	Half	-40°C to +105°C	28-Lead SOIC_W_FP	RN-28-1
ADM2561EBRNZ-RL7	3	0.5	Half	-40°C to +105°C	28-Lead SOIC_W_FP	RN-28-1
ADM2563EBRNZ	3	0.5	Full	-40°C to +105°C	28-Lead SOIC_W_FP	RN-28-1
ADM2563EBRNZ-RL7	3	0.5	Full	-40°C to +105°C	28-Lead SOIC_W_FP	RN-28-1
ADM2565EBRNZ	3	25	Half	-40°C to +105°C	28-Lead SOIC_W_FP	RN-28-1
ADM2565EBRNZ-RL7	3	25	Half	-40°C to +105°C	28-Lead SOIC_W_FP	RN-28-1
ADM2567EBRNZ	3	25	Full	-40°C to +105°C	28-Lead SOIC_W_FP	RN-28-1
ADM2567EBRNZ-RL7	3	25	Full	-40°C to +105°C	28-Lead SOIC_W_FP	RN-28-1
EVAL-ADM2561EEBZ					Half Duplex Evaluation Board	
EVAL-ADM2563EEBZ					Full Duplex Evaluation Board	
EVAL-ADM2565EEBZ					Half Duplex Evaluation Board	
EVAL-ADM2567EEBZ					Full Duplex Evaluation Board	

<sup>1</sup> Z = RoHS Compliant Part.