

OA938 Series

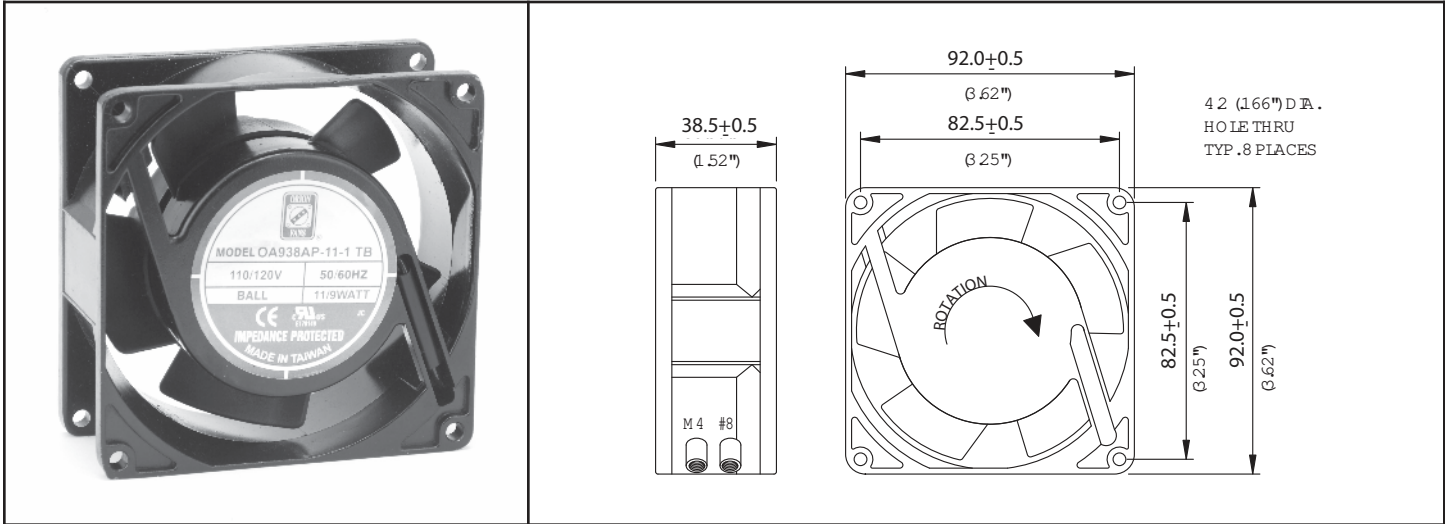

AC Fan - 115V, 230V
92 x 38mm(3.62" x 1.5")



Frame	Diecast Aluminum	<u>Operating Temperature</u> Ball Bearing -20C ~ +80C Sleeve Bearing -10C ~ +50C Storage Temp -40C ~ +80C <u>Life Expectancy</u> Ball Bearing 60,000 hours (L10 at 40C) Sleeve Bearing 30,000 hours (L10 at 40C) Weight: ~ 0.98 lbs. m0	
Impeller	PBT, UL94V-0 plastic		
Connection	2x Lead Wires 22 AWG or terminals		
Motor	Shaded pole, impedance protected		
Bearing System	Dual ball or Sleeve		
Insulation Resistance	>100M ohm between lead-wire and frame (500VDC)		
Dielectric Strength	1 min at 1500 VAC, 50/60Hz		

Model Number	Speed (RPM)	Airflow (CFM)	Noise (dB)	Volts AC	Voltage Range	Watts	Max. Static Pressure (\"H ₂ O)
OA938AP-11-1 *	3100	50	32	115	80~130	9	.22
OA938AP-11-2 *	2400	39	23	115	80~130	5	.17
OA938AP-11-3 *	1800	26	19	115	80~130	3	.10
OA938AP-22-1 *	3100	50	32	230	160~260	9	.22
OA938AP-22-2 *	2400	39	23	230	160~260	5	.17
OA938AP-22-3 *	1800	26	19	230	160~260	3	.10

* Indicate "TB" (Terminal Ball Bearing), "WB" (12" Wire Leads, Ball Bearing), "TS" (Terminal, Sleeve Bearing), "WS" (12" Wire Leads, Sleeve Bearing)