



## GaAs InGaP HBT MMIC POWER AMPLIFIER, 2.2 - 2.8 GHz

### Typical Applications

This amplifier is ideal for use as a power amplifier for 2.2 - 2.7 GHz applications:

- BLUETOOTH
- MMDS

### Features

- Gain: 20 dB
- Saturated Power: +30 dBm
- 32% PAE
- Supply Voltage: +2.75V to +5V
- Power Down Capability
- Low External Part Count

### Functional Diagram

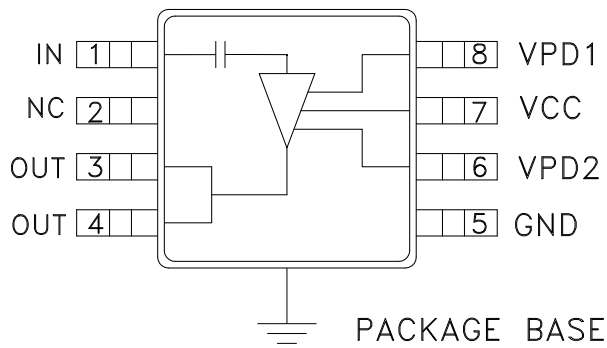

### General Description

The HMC414MS8G & HMC414MS8GE are high efficiency GaAs InGaP Heterojunction Bipolar Transistor (HBT) MMIC Power amplifiers which operate between 2.2 and 2.8 GHz. The amplifier is packaged in a low cost, surface mount 8 leaded package with an exposed base for improved RF and thermal performance. With a minimum of external components, the amplifier provides 20 dB of gain, +30 dBm of saturated power at 32% PAE from a +5V supply voltage. The amplifier can also operate with a 3.6V supply. Vpd can be used for full power down or RF output power/current control.

### Electrical Specifications, $T_A = +25^\circ C$ , As a Function of $V_s$ , $V_{pd} = 3.6V$

| Parameter                                  | $V_s = 3.6V$                       |      |      | $V_s = 5V$  |      |      | Units  |
|--|------------------------------------|------|------|-------------|------|------|--------|
|  | Min.                               | Typ. | Max. | Min.        | Typ. | Max. |        |
| Frequency Range                            | 2.2 - 2.8                          |      |      | 2.2 - 2.8   |      |      | GHz    |
| Gain                                       | 17                                 | 20   | 25   | 17          | 20   | 25   | dB     |
| Gain Variation Over Temperature            |                                    | 0.03 | 0.04 |             | 0.03 | 0.04 | dB/ °C |
| Input Return Loss                          |                                    | 8    |      |             | 8    |      | dB     |
| Output Return Loss                         |                                    | 9    |      |             | 9    |      | dB     |
| Output Power for 1 dB Compression (P1dB)   | 21                                 | 25   |      | 23          | 27   |      | dBm    |
| Saturated Output Power (P <sub>sat</sub> ) |                                    | 27   |      |             | 30   |      | dBm    |
| Output Third Order Intercept (IP3)         | 30                                 | 35   |      | 35          | 39   |      | dBm    |
| Noise Figure                               |                                    | 6.5  |      |             | 7.0  |      | dB     |
| Supply Current (I <sub>cq</sub> )          | V <sub>pd</sub> = 0V / 3.6V        |      |      | 0.002 / 300 |      |      | mA     |
| Control Current (I <sub>pd</sub> )         | V <sub>pd</sub> = 3.6V             |      |      | 7           |      |      | mA     |
| Switching Speed                            | t <sub>ON</sub> , t <sub>OFF</sub> |      |      | 45          |      |      | ns     |

Information furnished by Analog Devices is believed to be accurate and reliable. However, no responsibility is assumed by Analog Devices for its use, nor for any infringements of patents or other rights of third parties that may result from its use. Specifications subject to change without notice. No license is granted by implication or otherwise under any patent or patent rights of Analog Devices. Trademarks and registered trademarks are the property of their respective owners.

For price, delivery, and to place orders: Analog Devices, Inc., One Technology Way, P.O. Box 9106, Norwood, MA 02062-9106  
Phone: 781-329-4700 • Order online at [www.analog.com](http://www.analog.com)  
Application Support: Phone: 1-800-ANALOG-D



**Gain vs. Temperature, Vs= 3.6V**

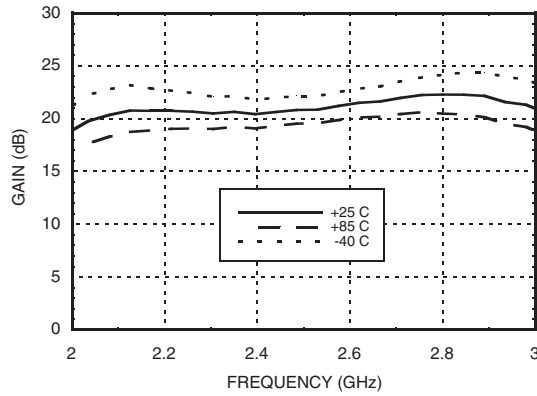

**Gain vs. Temperature, Vs= 5V**

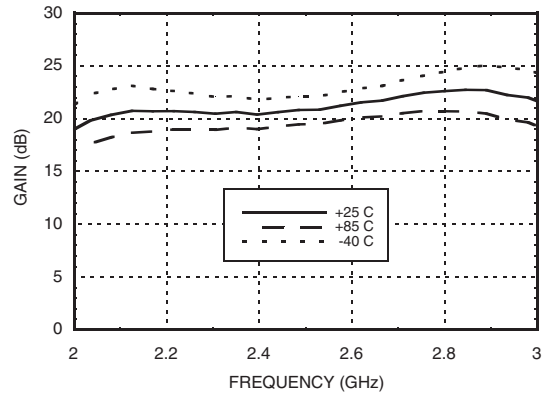

**Return Loss, Vs= 3.6V**

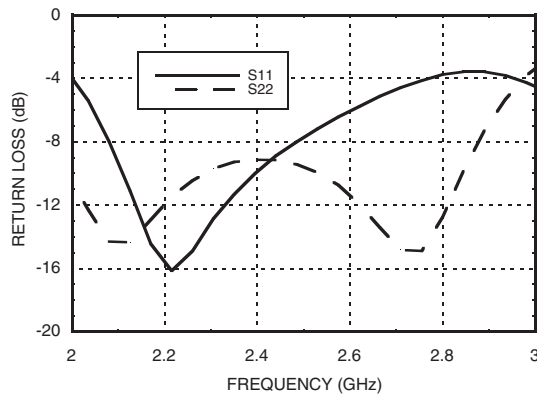

**Return Loss, Vs= 5V**

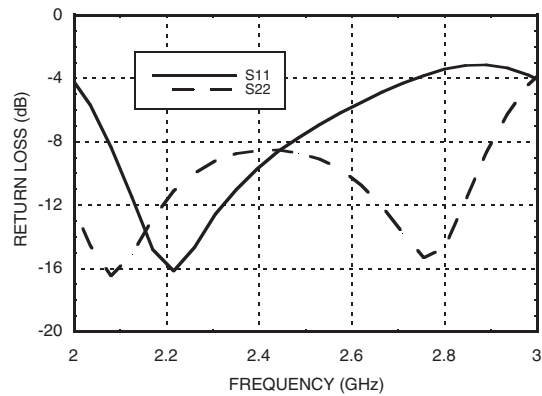

**P1dB vs. Temperature, Vs= 3.6V**

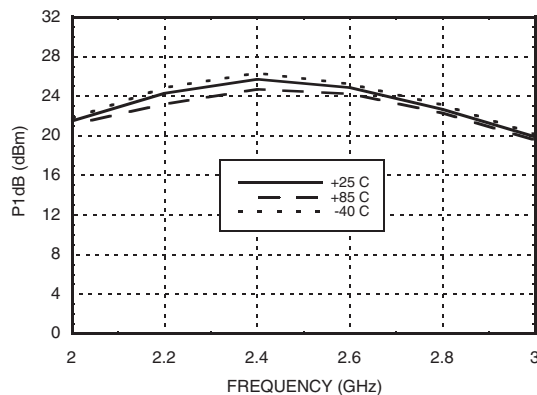

**P1dB vs. Temperature, Vs= 5V**

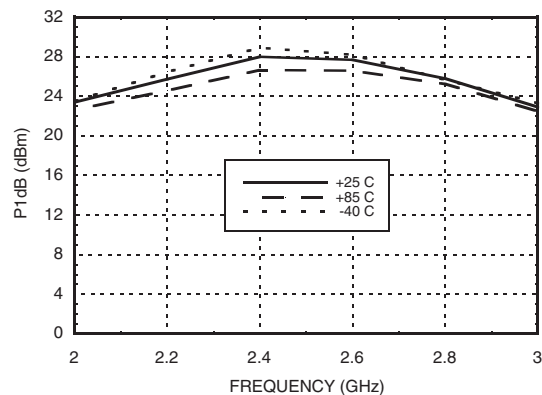

Information furnished by Analog Devices is believed to be accurate and reliable. However, no responsibility is assumed by Analog Devices for its use, nor for any infringements of patents or other rights of third parties that may result from its use. Specifications subject to change without notice. No license is granted by implication or otherwise under any patent or patent rights of Analog Devices. Trademarks and registered trademarks are the property of their respective owners.

For price, delivery, and to place orders: Analog Devices, Inc., One Technology Way, P.O. Box 9106, Norwood, MA 02062-9106 Phone: 781-329-4700 • Order online at [www.analog.com](http://www.analog.com) Application Support: Phone: 1-800-ANALOG-D



**HMC414MS8G / 414MS8GE**

**GaAs InGaP HBT MMIC  
POWER AMPLIFIER, 2.2 - 2.8 GHz**

**Psat vs. Temperature, Vs= 3.6V**

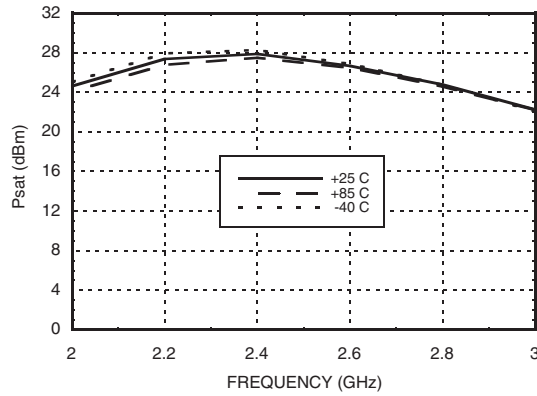

**Psat vs. Temperature, Vs= 5V**

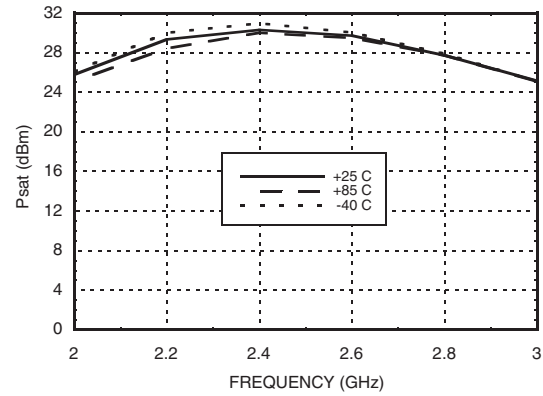

**Power Compression@ 2.4 GHz, Vs= 3.6V**

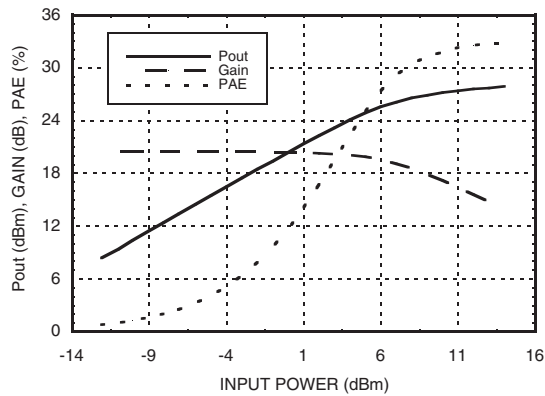

**Power Compression@ 2.4 GHz, Vs= 5V**

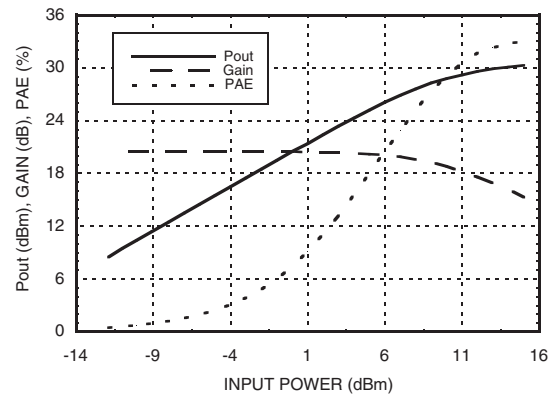

**Output IP3 vs. Temperature, Vs= 3.6V**

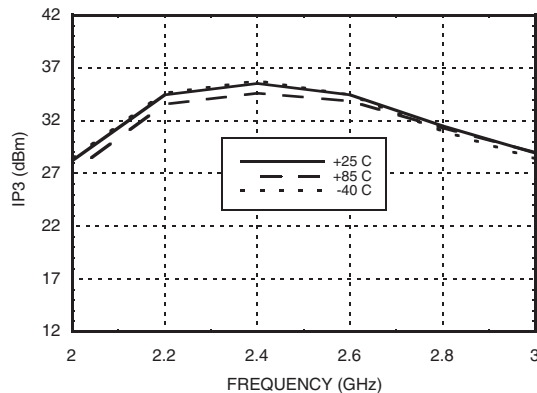

**Output IP3 vs. Temperature, Vs= 5V**

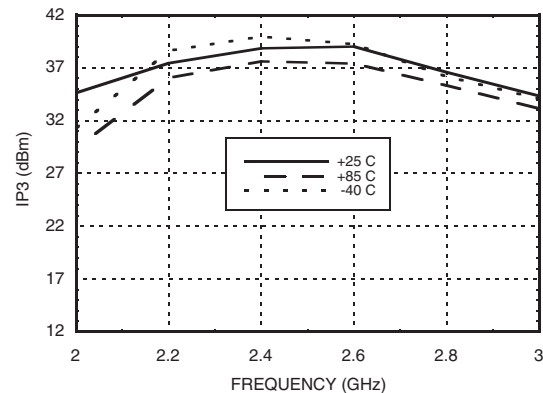

Information furnished by Analog Devices is believed to be accurate and reliable. However, no responsibility is assumed by Analog Devices for its use, nor for any infringements of patents or other rights of third parties that may result from its use. Specifications subject to change without notice. No license is granted by implication or otherwise under any patent or patent rights of Analog Devices. Trademarks and registered trademarks are the property of their respective owners.

For price, delivery, and to place orders: Analog Devices, Inc., One Technology Way, P.O. Box 9106, Norwood, MA 02062-9106 Phone: 781-329-4700 • Order online at [www.analog.com](http://www.analog.com) Application Support: Phone: 1-800-ANALOG-D



**GaAs InGaP HBT MMIC  
POWER AMPLIFIER, 2.2 - 2.8 GHz**

**Reverse Isolation vs. Temperature, Vs= 3.6V**

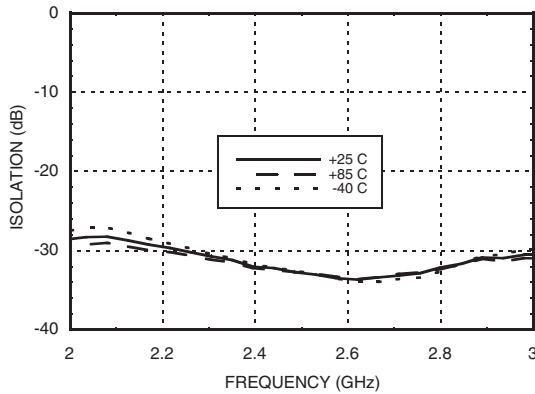

**Power Down Isolation, Vs= 3.6V**

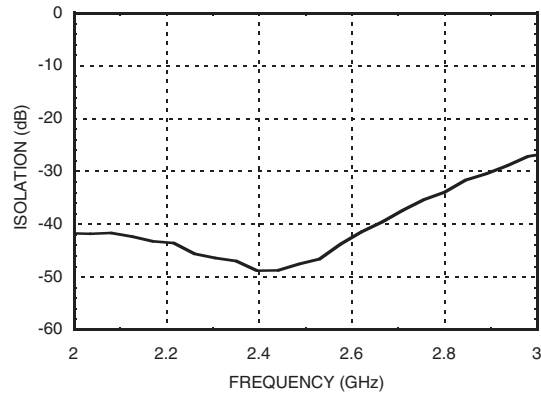

**Noise Figure vs. Temperature, Vs= 3.6V**

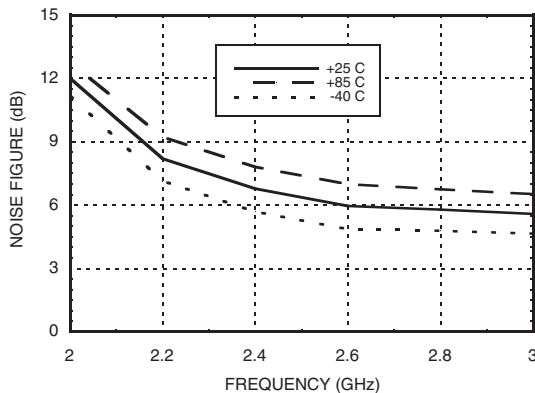

**Noise Figure vs. Temperature, Vs= 5V**

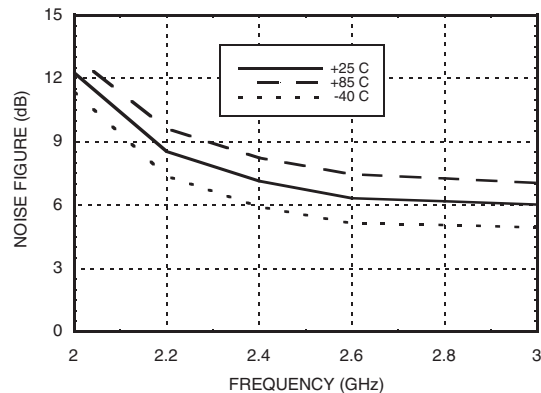

**Gain & Power vs. Supply Voltage**

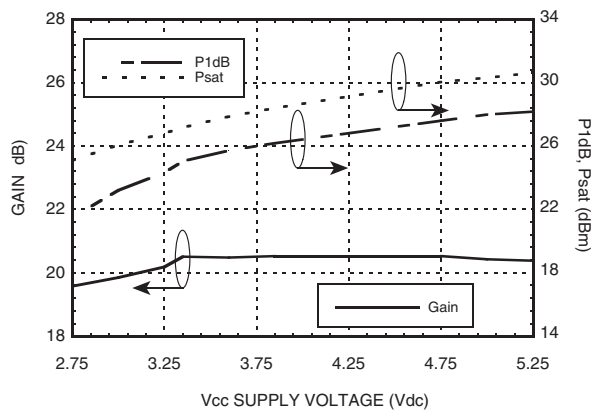

**Gain, Power & Quiescent Supply Current vs Vpd@ 2.4 GHz**

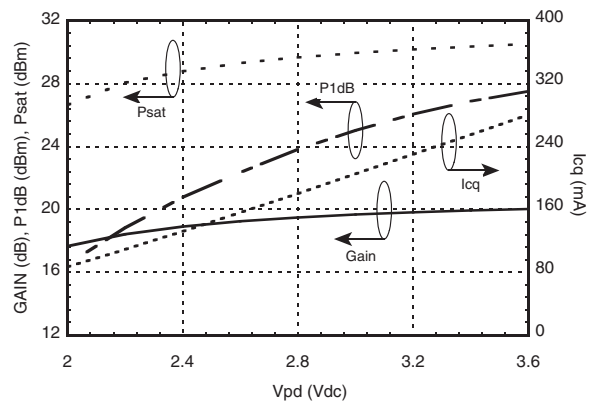

Information furnished by Analog Devices is believed to be accurate and reliable. However, no responsibility is assumed by Analog Devices for its use, nor for any infringements of patents or other rights of third parties that may result from its use. Specifications subject to change without notice. No license is granted by implication or otherwise under any patent or patent rights of Analog Devices. Trademarks and registered trademarks are the property of their respective owners.

For price, delivery, and to place orders: Analog Devices, Inc., One Technology Way, P.O. Box 9106, Norwood, MA 02062-9106 Phone: 781-329-4700 • Order online at [www.analog.com](http://www.analog.com) Application Support: Phone: 1-800-ANALOG-D



## GaAs InGaP HBT MMIC POWER AMPLIFIER, 2.2 - 2.8 GHz

### Absolute Maximum Ratings

|   |                |
|---|----------------|
| Collector Bias Voltage (Vcc)  | +5.5 Vdc       |
| Control Voltage (Vpd1, Vpd2)  | +4.0 Vdc       |
| RF Input Power (RFIN)(Vs = +5.0, Vpd = +3.6 Vdc)                          | +17 dBm        |
| Junction Temperature  | 150 °C         |
| Continuous P <sub>diss</sub> (T = 85 °C)<br>(derate 27 mW/°C above 85 °C) | 1.755 W        |
| Thermal Resistance<br>(junction to ground paddle)                         | 37 °C/W        |
| Storage Temperature   | -65 to +150 °C |
| Operating Temperature   | -40 to +85 °C  |



ELECTROSTATIC SENSITIVE DEVICE  
OBSERVE HANDLING PRECAUTIONS

### Outline Drawing

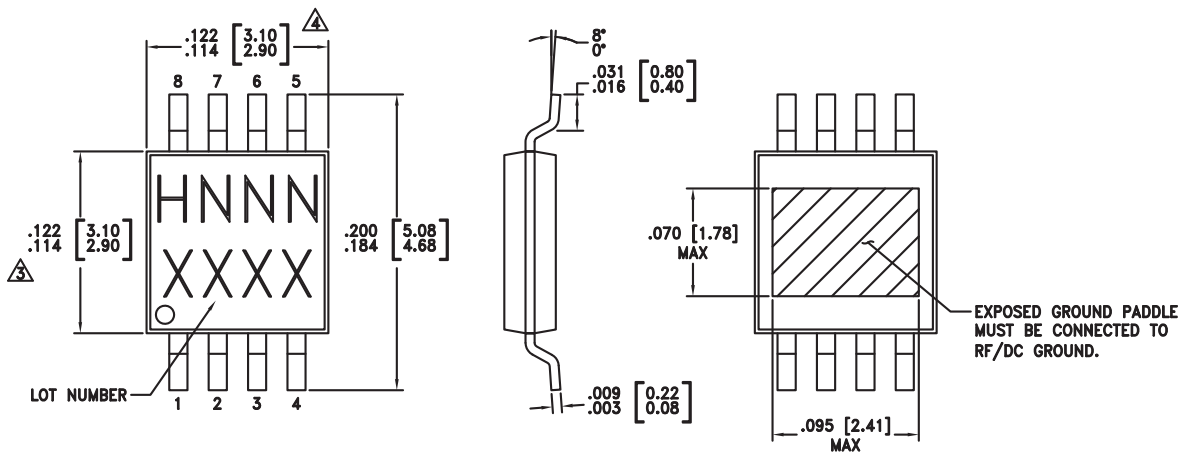

#### NOTES:

- LEADFRAME MATERIAL: COPPER ALLOY
- DIMENSIONS ARE IN INCHES [MILLIMETERS].
- △ DIMENSION DOES NOT INCLUDE MOLDFLASH OF 0.15mm PER SIDE.
- ▲ DIMENSION DOES NOT INCLUDE MOLDFLASH OF 0.25mm PER SIDE.
- ALL GROUND LEADS AND GROUND PADDLE MUST BE SOLDERED TO PCB RF GROUND.

### Package Information

| Part Number | Package Body Material                              | Lead Finish   | MSL Rating          | Package Marking <sup>[3]</sup> |
|-------------|--|---------------|---------------------|--------------------------------|
| HMC414MS8G  | Low Stress Injection Molded Plastic                | Sn/Pb Solder  | MSL1 <sup>[1]</sup> | H414<br>XXXX                   |
| HMC414MS8GE | RoHS-compliant Low Stress Injection Molded Plastic | 100% matte Sn | MSL1 <sup>[2]</sup> | H414<br>XXXX                   |



[1] Max peak reflow temperature of 235 °C

[2] Max peak reflow temperature of 260 °C

[3] 4-Digit lot number XXXX

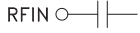
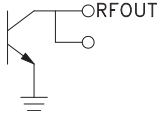

### Pin Descriptions

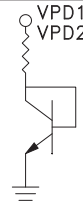
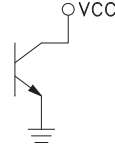
| Pin Number | Function   | Description  | Interface Schematic   |
|------------|------------|--|---|
| 1          | RFIN       | This pin is AC coupled and matched to 50 Ohms.   |    |
| 2          | NC         | Not Connected.   |   |
| 3, 4       | RFOUT      | RF output and DC bias for the output stage.  |    |
| 5          | GND        | Ground: Backside of package has exposed metal ground slug that must be connected to ground thru a short path. Vias under the device are required.  |    |
| 6, 8       | Vpd1, Vpd2 | Power control pin. For maximum power, this pin should be connected to 3.6V. For 5V operation, a dropping resistor is required. A higher voltage is not recommended. For lower idle current, this voltage can be reduced. |   |
| 7          | Vcc        | Power supply voltage for the first amplifier stage. An external bypass capacitor of 330 pF is required as shown in the application schematic.  |  |



**Evaluation PCB**

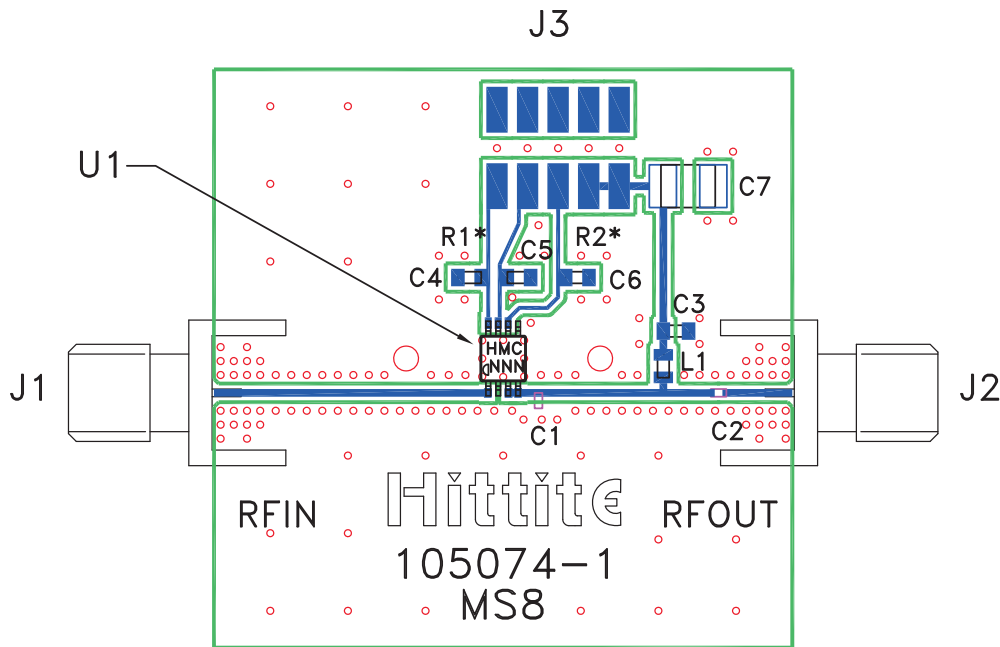

\* For 5V operation on Vctl line, select R1, R2 such that 3.6V is presented on Pins 6 and 8.

**List of Materials for Evaluation PCB 105006 [1]**

| Item    | Description                        |
|---------|------------------------------------|
| J1 - J2 | PCB Mount SMA RF Connector         |
| J3      | 2 mm DC Header                     |
| C1      | 2.7 pF Capacitor, 0603 Pkg.        |
| C2      | 100 pF Capacitor, 0402 Pkg.        |
| C3 - C6 | 330 pF Capacitor, 0603 Pkg.        |
| C7      | 2.2 μF Capacitor, Tantalum         |
| L1      | 18nH Inductor 0603 Pkg.            |
| U1      | HMC414MS8G / HMC414MS8GE Amplifier |
| PCB [2] | 105074 Eval Board                  |

The circuit board used in the final application should use RF circuit design techniques. Signal lines should have 50 ohm impedance while the package ground leads and exposed paddle should be connected directly to the ground plane similar to that shown. A sufficient number of via holes should be used to connect the top and bottom ground planes. The evaluation board should be mounted to an appropriate heat sink. The evaluation circuit board shown is available from Hittite upon request.

[1] Reference this number when ordering complete evaluation PCB

[2] Circuit Board Material: Rogers 4350



**GaAs InGaP HBT MMIC  
POWER AMPLIFIER, 2.2 - 2.8 GHz**

**Application Circuit**

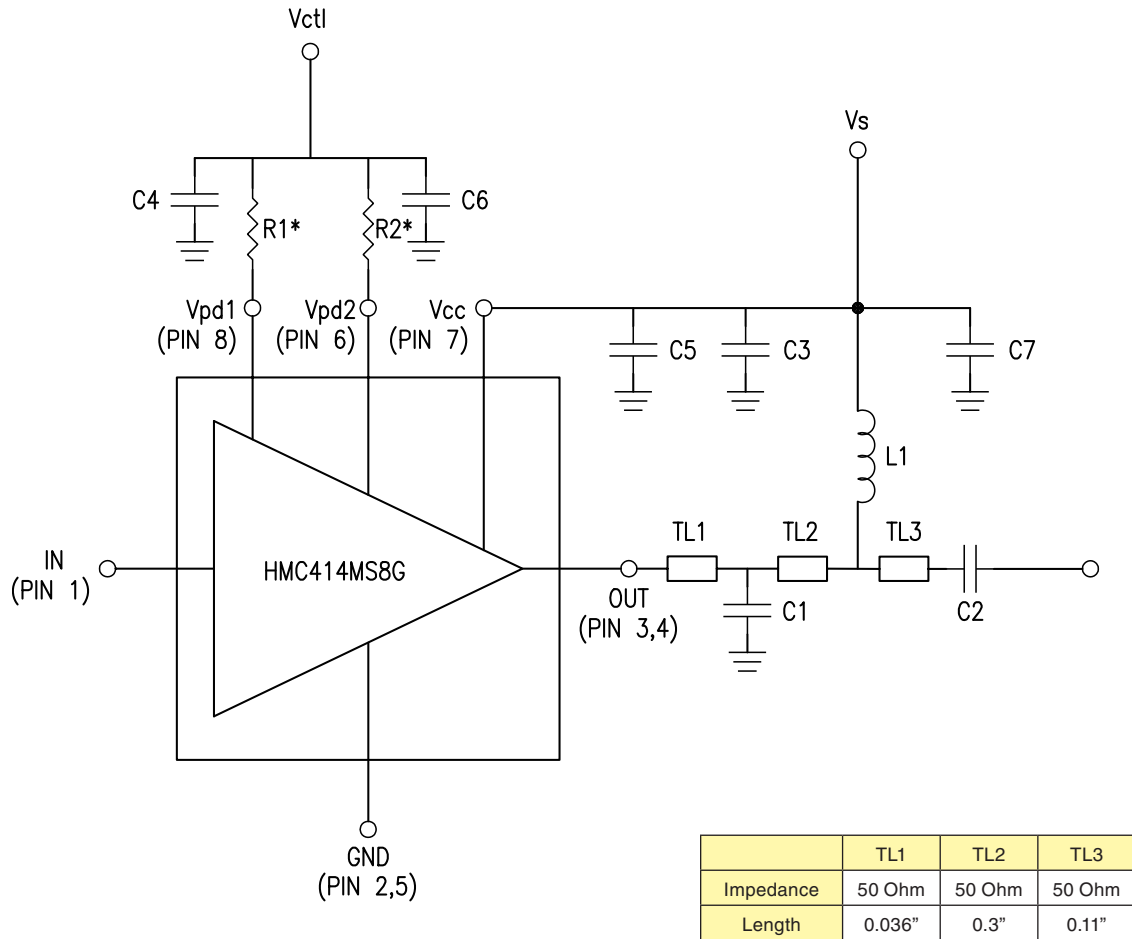

\* For 5V operation on Vctl line, select R1, R2 such that 3.6V is presented on Pins 6 and 8.