

November 1996

Features

- Slew Rate 30V/ μ s
- Fast Settling 330ns
- Full Power Bandwidth 500kHz
- Gain Bandwidth 12MHz
- High Input Impedance 50M Ω
- Low Offset Current 10nA
- Internally Compensated For Unity Gain Stability

Applications

- Data Acquisition Systems
- RF Amplifiers
- Video Amplifiers
- Signal Generators

Ordering Information

PART NUMBER	TEMP RANGE (°C)	PACKAGE	PKG. NO.
HA2-2500-2	-55 to 125	8 Pin Metal Can	T8.C
HA2-2502-2	-55 to 125	8 Pin Metal Can	T8.C
HA2-2505-5	0 to 75	8 Pin Metal Can	T8.C
HA3-2505-5	0 to 75	8 Ld PDIP	E8.3
HA7-2500-2	-55 to 125	8 Ld CERDIP	F8.3A
HA7-2505-5	0 to 75	8 Ld CERDIP	F8.3A

Description

HA-2500, HA-2502, HA-2505 comprises a series of operational amplifiers whose designs are optimized to deliver excellent slew rate, bandwidth, and settling time specifications. The outstanding dynamic features of this internally compensated device are complemented with low offset voltage and offset current.

These dielectrically isolated amplifiers are ideally suited for applications such as data acquisition, RF, video, and pulse conditioning circuits. Slew rates of $\pm 30\text{V}/\mu\text{s}$ and 330ns (0.1%) settling time make these devices excellent components in fast, accurate data acquisition and pulse amplification designs. 12MHz small signal bandwidth and 500kHz power bandwidth make these devices well suited to RF and video applications. With 2mV typical offset voltage plus offset trim capability and 10nA offset current, HA-2500, HA-2502, HA-2505 are particularly useful components in signal conditioning designs.

The gain and offset voltage figures of the HA-2500 series are optimized by internal component value changes while the similar design of the HA-2510 series is maximized for slew rate.

MIL-STD-883 product and data sheets are available upon request.

Pinouts

HA-2500/02 (CERDIP)
HA-2505 (PDIP, CDIP)
TOP VIEW

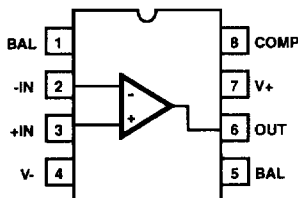

HA-2500/02/05
(METAL CAN)
TOP VIEW

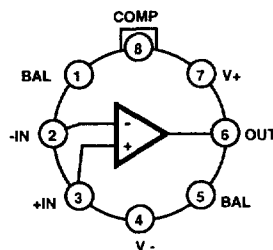

HA-2500, HA-2502, HA-2505

Absolute Maximum Ratings

Supply Voltage Between V+ and V- Terminals	40V
Differential Input Voltage	15V
Peak Output Current	50mA

Operating Conditions

Temperature Range	
HA-2500/2502-2	-55°C to 125°C
HA-2505-5	0°C to 75°C

Thermal Information

Thermal Resistance (Typical, Note 1)	θ_{JA} (°C/W)	θ_{JC} (°C/W)
Metal Can Package	165	80
PDIP Package	96	N/A
CERDIP Package	135	50
Maximum Junction Temperature (Hermetic Package)	175°C	
Maximum Junction Temperature (Plastic Package)	150°C	
Maximum Storage Temperature Range	-65°C to 150°C	
Maximum Lead Temperature (Soldering 10s)	300°C	

CAUTION: Stresses above those listed in "Absolute Maximum Ratings" may cause permanent damage to the device. This is a stress only rating and operation of the device at these or any other conditions above those indicated in the operational sections of this specification is not implied.

NOTE:

- θ_{JA} is measured with the component mounted on an evaluation PC board in free air.

Electrical Specifications $V_S = \pm 15V$

PARAMETER	TEMP (°C)	HA-2500-2			HA-2502-2			HA-2505-5			UNITS
		MIN	TYP	MAX	MIN	TYP	MAX	MIN	TYP	MAX	
INPUT CHARACTERISTICS											
Offset Voltage	25	-	2	5	-	4	8	-	4	8	mV
	Full	-	-	8	-	-	10	-	-	10	mV
Offset Voltage Average Drift	Full	-	20	-	-	20	-	-	20	-	$\mu V/^\circ C$
Bias Current	25	-	100	200	-	125	250	-	125	250	nA
	Full	-	-	400	-	-	500	-	-	500	nA
Offset Current	25	-	10	25	-	20	50	-	20	50	nA
	Full	-	-	50	-	-	100	-	-	100	nA
Input Resistance (Note 2)	25	25	50	-	20	50	-	20	50	-	M Ω
Common Mode Range	Full	± 10	-	-	± 10	-	-	± 10	-	-	V
TRANSFER CHARACTERISTICS											
Large Signal Voltage Gain (Notes 3, 6)	25	20	30	-	15	25	-	15	25	-	kV/V
	Full	15	-	-	10	-	-	10	-	-	kV/V
Common Mode Rejection Ratio (Note 4)	Full	80	90	-	74	90	-	74	90	-	dB
Gain Bandwidth Product (Note 5)	25	-	12	-	-	12	-	-	12	-	MHz
OUTPUT CHARACTERISTICS											
Output Voltage Swing (Note 3)	Full	± 10	± 12	-	± 10	± 12	-	± 10	± 12	-	V
Output Current (Note 6)	25	± 10	± 20	-	± 10	± 20	-	± 10	± 20	-	mA
Full Power Bandwidth (Notes 6, 11)	25	350	500	-	300	500	-	300	500	-	kHz
TRANSIENT RESPONSE											
Rise Time (Notes 3, 7, 8, 9)	25	-	25	50	-	25	50	-	25	50	ns
Overshoot (Notes 3, 7, 8, 9)	25	-	25	40	-	25	50	-	25	50	%
Slew Rate (Notes 3, 7, 9, 12)	25	± 25	± 30	-	± 20	± 30	-	± 20	± 30	-	V/ μs
Settling Time to 0.1% (Notes 3, 7, 9, 12)	25	-	0.33	-	-	0.33	-	-	0.33	-	μs

3

OPERATIONAL AMPLIFIERS

HA-2500, HA-2502, HA-2505

Electrical Specifications $V_S = \pm 15V$ (Continued)

PARAMETER	TEMP (°C)	HA-2500-2			HA-2502-2			HA-2505-5			UNITS
		MIN	TYP	MAX	MIN	TYP	MAX	MIN	TYP	MAX	
POWER SUPPLY CHARACTERISTICS											
Supply Current	25	-	4	6	-	4	6	-	4	6	mA
PSRR (Note 10)	Full	80	90	-	74	90	-	74	90	-	dB

NOTES:

- This parameter value is based on design calculations.
- $R_L = 2k\Omega$.
- $V_{CM} = \pm 10V$.
- $A_v > 10$.
- $V_O = \pm 10V$.
- $C_L = 50pF$.
- $V_O = \pm 200mV$.
- See Transient Response Test Circuits and Waveforms.
- $\Delta V = \pm 5V$.
- Full Power Bandwidth guaranteed based on slew rate measurement using: $FPBW = \text{Slew Rate}/2\pi V_{PEAK}$.
- $V_{OUT} = \pm 5V$.

Test Circuits and Waveforms

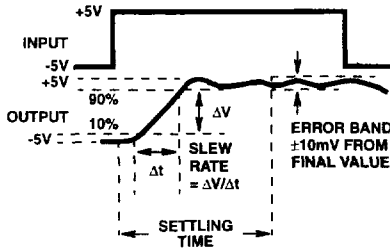

NOTE: Measured on both positive and negative transitions from 0V to +200mV and 0V to -200mV at the output.
FIGURE 1. SLEW RATE AND SETTling TIME

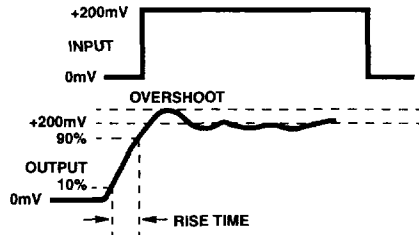
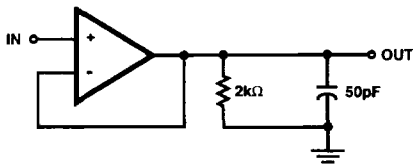
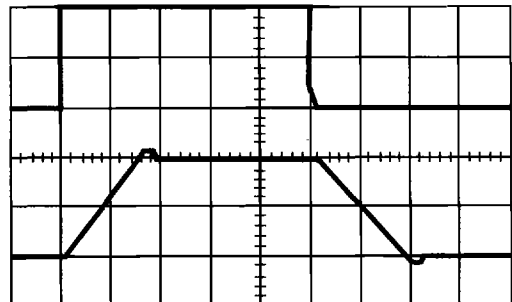

FIGURE 2. TRANSIENT RESPONSE



NOTE: Measured on both positive and negative transitions from 0V to +200mV and 0V to -200mV at the output.
FIGURE 3. SLEW RATE AND TRANSIENT RESPONSE



$R_L = 2k\Omega$, $C_L = 50pF$ Vertical = 5V/Div.
 Upper Trace: Input Horizontal = 200ns/Div.
 Lower Trace: Output $T_A = 25^\circ C$, $V_S = \pm 15V$

FIGURE 4. VOLTAGE FOLLOWER PULSE RESPONSE

Test Circuits and Waveforms (Continued)

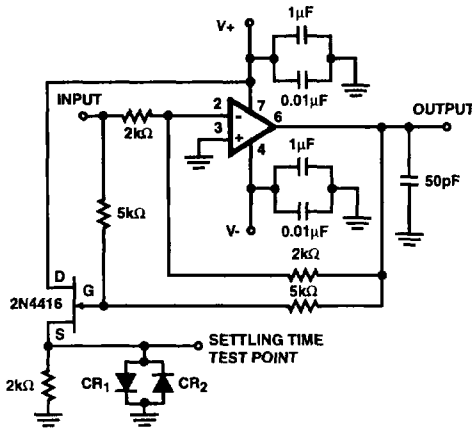

13. $A_V = -1$.
14. Feedback and Summing Resistor Ratios should be 0.1% matched.
15. Clipping Diodes CR₁ and CR₂ are optional. HP5082-2810 recommended.

FIGURE 5. SETTLING TIME TEST CIRCUIT

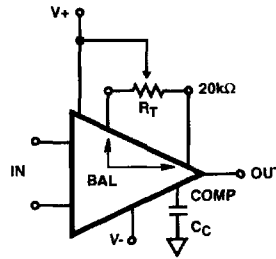

NOTE: Tested offset adjustment range is $1V_{OS} + 1mV$ minimum referred to output. Typical ranges are $\pm 6mV$ with $R_T = 20k\Omega$.

FIGURE 6. SUGGESTED V_{OS} ADJUSTMENT AND COMPENSATION HOOK UP

Schematic

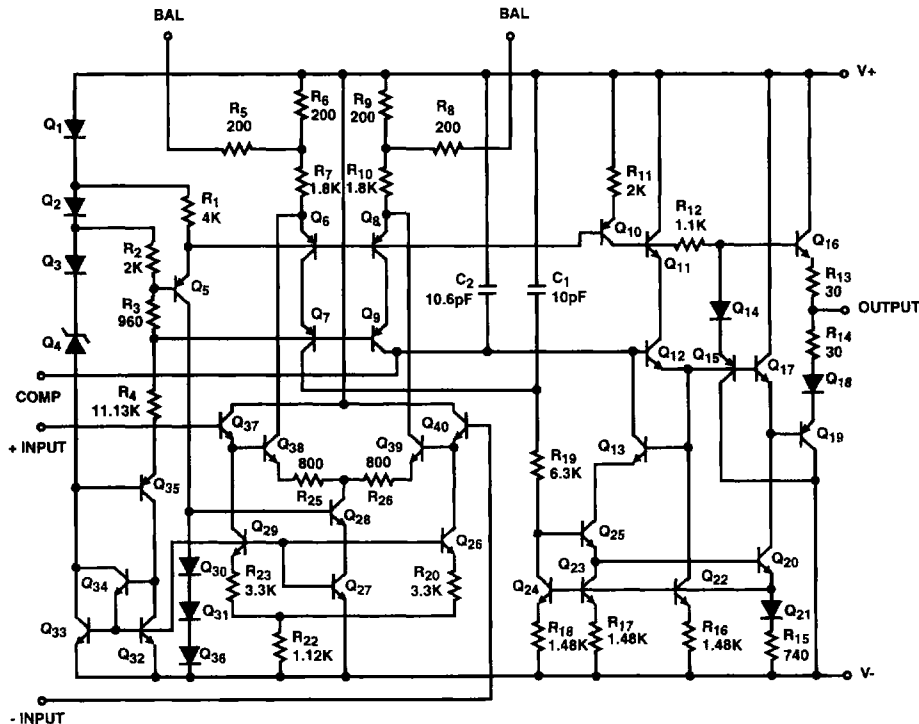

HA-2500, HA-2502, HA-2505

Typical Performance Curves $V_S = \pm 15V$, $T_A = 25^\circ C$, Unless Otherwise Specified

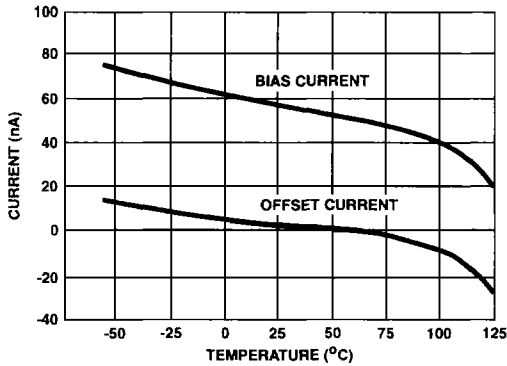

FIGURE 7. INPUT BIAS AND OFFSET CURRENT vs TEMPERATURE

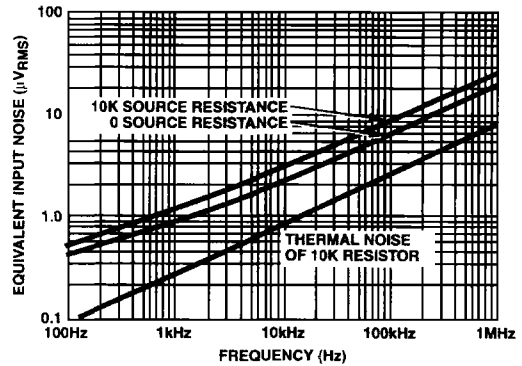

FIGURE 8. EQUIVALENT INPUT NOISE vs BANDWIDTH (WITH 10Hz HIGH PASS FILTER)

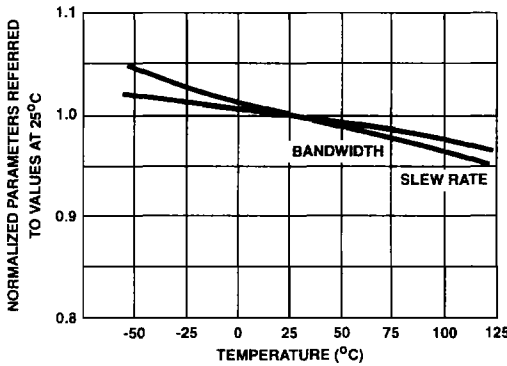

FIGURE 9. NORMALIZED AC PARAMETERS vs TEMPERATURE

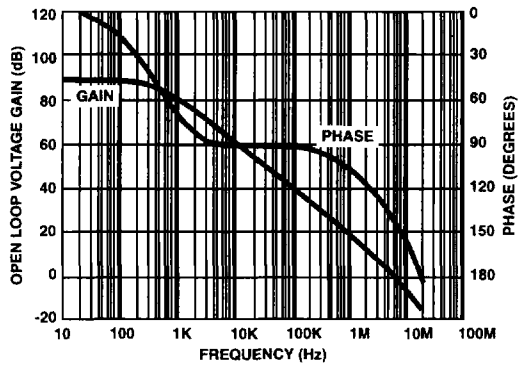

FIGURE 10. OPEN LOOP FREQUENCY AND PHASE RESPONSE

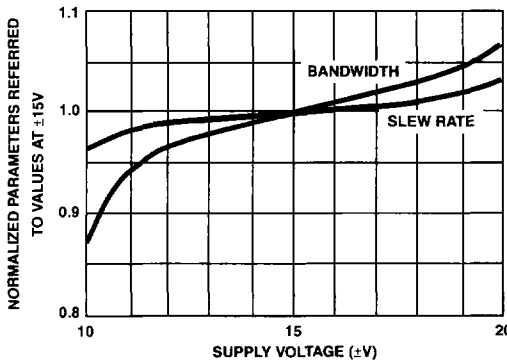
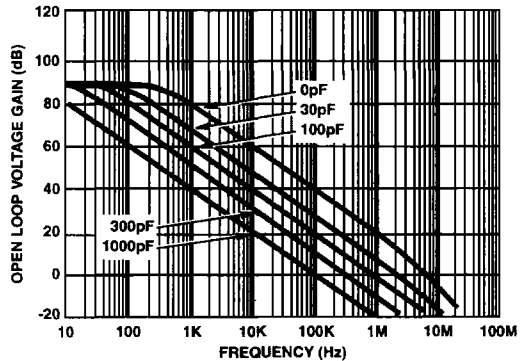

FIGURE 11. NORMALIZED AC PARAMETERS vs SUPPLY VOLTAGE



NOTE: External compensation components are not required for stability, but may be added to reduce bandwidth if desired.

FIGURE 12. OPEN LOOP FREQUENCY RESPONSE FOR VARIOUS VALUES OF CAPACITORS FROM COMPENSATION PIN TO GROUND

Typical Performance Curves $V_S = \pm 15V$, $T_A = 25^\circ C$. Unless Otherwise Specified (Continued)

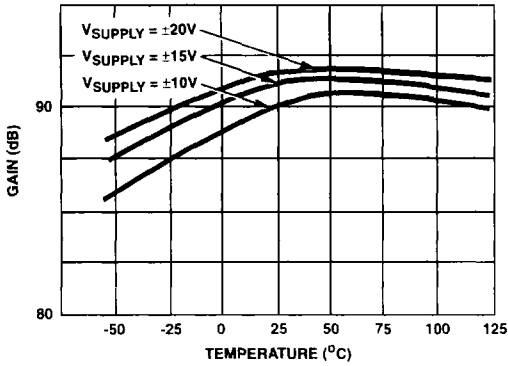

FIGURE 13. OPEN LOOP VOLTAGE GAIN vs TEMPERATURE

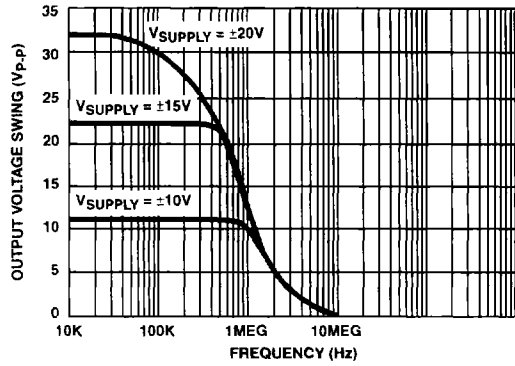

FIGURE 14. OUTPUT VOLTAGE SWING vs FREQUENCY

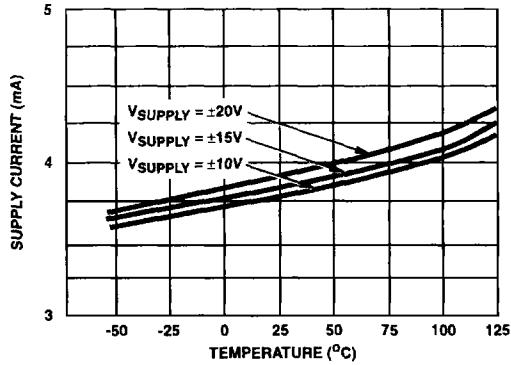

FIGURE 15. POWER SUPPLY CURRENT vs TEMPERATURE

HA-2500, HA-2502, HA-2505

Die Characteristics

DIE DIMENSIONS:

57 mils x 65 mils x 19 mils
1450 μ m x 1650 μ m x 483 μ m

METALLIZATION:

Type: Al, 1% Cu
Thickness: 16k \AA \pm 2k \AA

PASSIVATION:

Type: Nitride (Si₃N₄) over Silox (SiO₂, 5% Phos.)
Silox Thickness: 12k \AA \pm 2k \AA
Nitride Thickness: 3.5k \AA \pm 1.5k \AA

SUBSTRATE POTENTIAL (Powered Up):

Unbiased

TRANSISTOR COUNT:

40

PROCESS:

Bipolar Dielectric Isolation

Metallization Mask Layout

HA-2500, HA-2502

