

LOW DROPOUT VOLTAGE REGULATOR

■ GENERAL DESCRIPTION

The NJU7777 is a 150mA output low dropout voltage regulator with ON/OFF control.

Advanced CMOS technology achieves high ripple rejection and low quiescent current.

Small packaging and 1 μ F small decoupling capacitor make the NJU7777 suitable for space conscious applications.

■ PACKAGE OUTLINE



NJU7777F4

■ FEATURES

- High Ripple Rejection 65dB typ. (f=1kHz,Vo=3.0V version)
- Low quiescent Current Iq=18 μ A (Io=0mA)
- Output Current Io(max.)=150mA
- High Precision Output Vo \pm 1.0%
- Output capacitor with 1.0 μ F ceramic capacitor (Vo \geq 2.1V version)
- Low Dropout Voltage 0.13V typ. (Io=100mA,Vo=3.0V)
- ON/OFF Control
- Internal Short Circuit Current Limit
- Internal Thermal Overload Protection
- CMOS Technology
- Package Outline SC-82AB

■ PIN CONFIGURATION

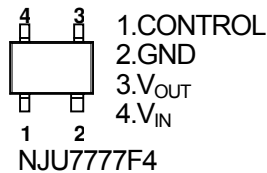

■ EQUIVALENT CIRCUIT

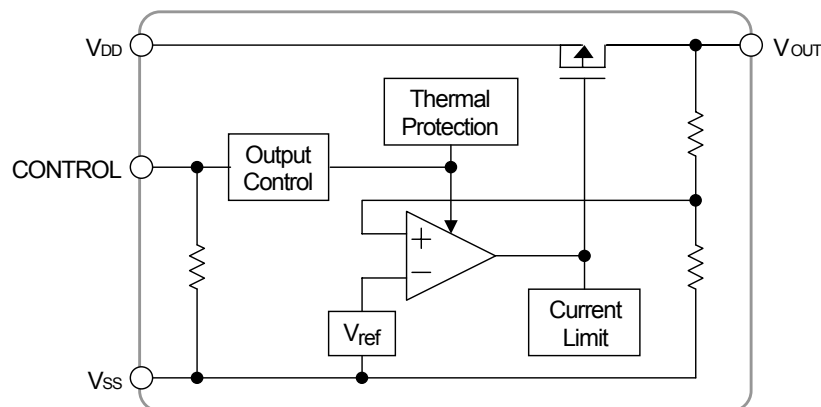

NJU7777

■ OUTPUT VOLTAGE RANK LIST

Device Name	V _{OUT}	Device Name	V _{OUT}
NJU7777F4-15	1.5V	NJU7777F4-33	3.3V
NJU7777F4-18	1.8V	NJU7777F4-05	5.0V
NJU7777F4-21	2.1V		
NJU7777F4-24	2.4V		
NJU7777F4-03	3.0V		

■ ABSOLUTE MAXIMUM RATINGS

(Ta=25°C)

PARAMETER	SYMBOL	RATINGS	UNIT
Input Voltage	V _{IN}	+9	V
Control Voltage	V _{CONT}	+9(*1)	V
Power Dissipation	P _D	250(*2)	mW
Operating Temperature	T _{opr}	-40 ~ +85	°C
Storage Temperature	T _{stg}	-40 ~ +125	°C

(*1) : When input voltage is less than +9V, the absolute maximum control voltage is equal to the input voltage.

(*2) : Mounted on glass epoxy board based on EIA/JEDEC. (114.3x76.2x1.6mm: 2Layers)

■ Operating voltage

V_{IN}=+2.3 ~ +8V (In case of Vo<2.1V version)

■ ELECTRICAL CHARACTERISTICS (V_{IN}=Vo+1V, C_{IN}=0.1μF, Co=1.0μF(Co=2.2μF: Vo≤2.0V), Ta=25°C)

PARAMETER	SYMBOL	TEST CONDITION	MIN.	TYP.	MAX.	UNIT	
Output Voltage	V _o	I _o =30mA	-1.0%	-	+1.0%	V	
Input Voltage	V _{IN}		2.3	-	8	V	
Quiescent Current	I _Q	I _o =0mA, V _{CONT} =V _{IN}	-	18	35	μA	
Quiescent Current at Control OFF	I _{Q(OFF)}	V _{CONT} =0V	-	0.1	1.0	μA	
Output Current	I _o	V _o -0.1V (Vo≤2.0V Version) V _o -0.3V (Vo≥2.1V Version)	150	-	-	mA	
Short Current Limit	I _{LIM}	V _o =0V	-	40	-	mA	
Line Regulation	ΔV _o /ΔV _{IN}	V _{IN} =Vo+1V ~ Vo+6.0V (Vo<2.0V Version) V _{IN} =Vo+1V ~ 8.0V (Vo≥2.0V Version), I _o =30mA	-	-	0.20	%/V	
Load Regulation	ΔV _o /ΔI _o	I _o =0 ~ 100mA	-	-	0.03	%/mA	
Dropout Voltage(*3)	ΔV _{I-O}	I _o =100mA	2.1V≤Vo≤2.4V	-	0.17	0.22	V
			2.5V≤Vo≤2.7V	-	0.15	0.20	V
			2.8V≤Vo≤3.3V	-	0.13	0.18	V
			3.4V≤Vo≤5.0V	-	0.11	0.16	V
Ripple Rejection	RR	e _{in} =200mVrms, f=1kHz, I _o =10mA, Vo=3.0V Version	-	65	-	dB	
Average Temperature Coefficient of Output Voltage	ΔV _o /ΔTa	Ta=0 ~ 85°C, I _o =10mA	-	±100	-	ppm/°C	
Output Noise Voltage	V _{NO}	f=10Hz ~ 80kHz, I _o =0mA, Vo=3.0V Version	-	75	-	μVrms	
Pull-down Resistance	R _{CONT}		2	5	10	MΩ	
Control Voltage for ON-state	V _{CONT(ON)}		1.6	-	-	V	
Control Voltage for OFF-state	V _{CONT(OFF)}		-	-	0.3	V	

(*3): Except output voltage less than 2.1V.

The above specification is a common specification for all output voltages.

Therefore, it may be different from the individual specification for a specific output voltage.

TEST CIRCUIT

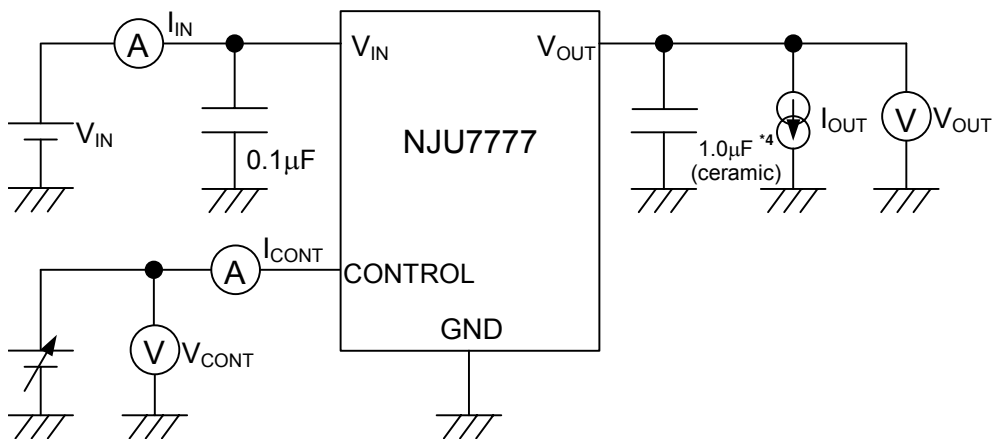

*4 $V_o \leq 2.0V$ version: $C_o = 2.2\mu F$ (ceramic)

POWER DISSIPATION vs. AMBIENT TEMPERATURE

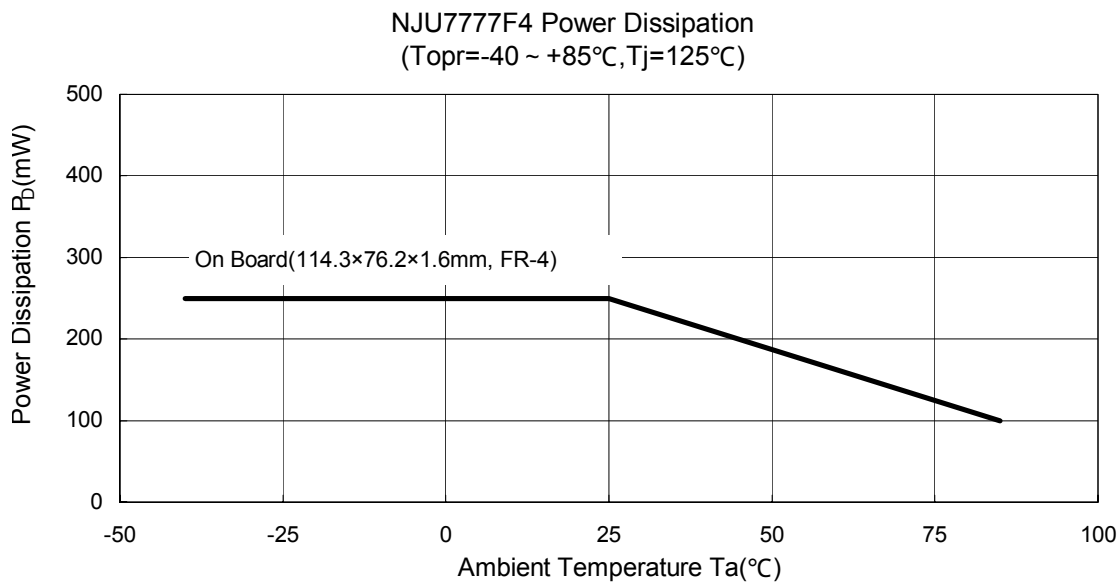

NJU7777

■ TYPICAL APPLICATION

① In case that ON/OFF Control is not required:

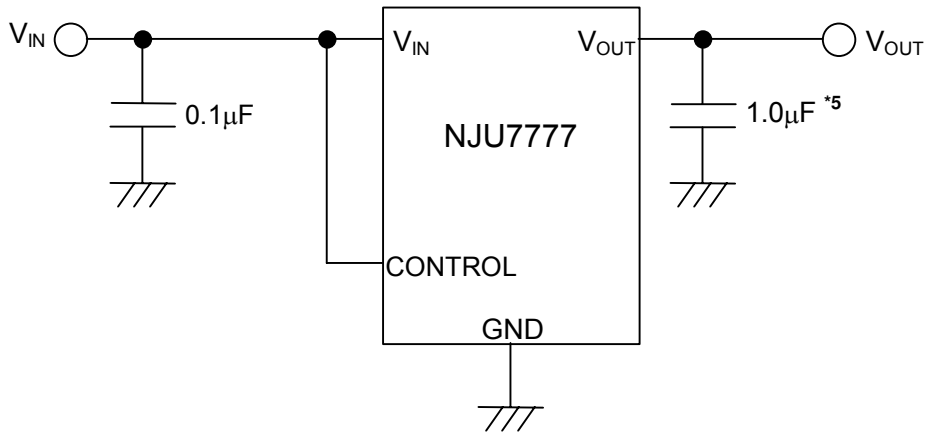

*5 $V_o \leq 2.0\text{V}$ version: $C_o = 2.2\mu\text{F}$

Connect control terminal to V_{IN} terminal.

② In use of ON/OFF Control

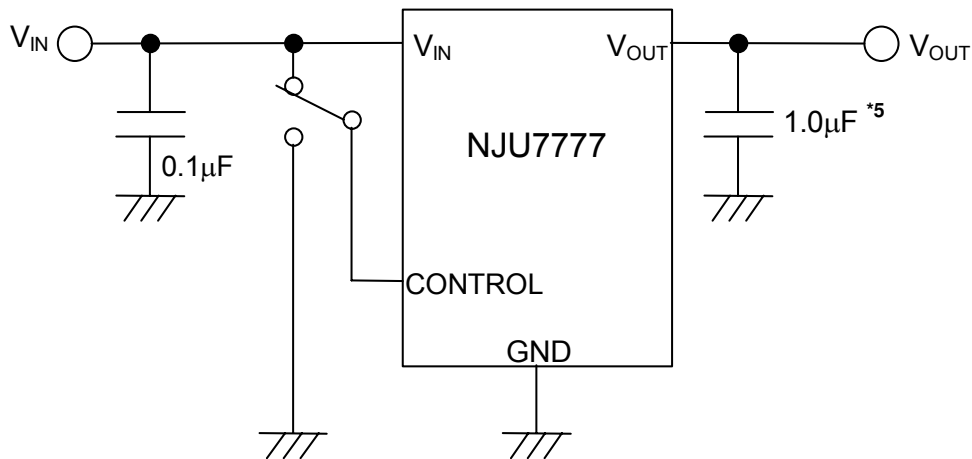

*5 $V_o \leq 2.0\text{V}$ version: $C_o = 2.2\mu\text{F}$

State of control terminal:

- "H" → output is enabled.
- "L" or "open" → output is disabled.

■ TYPICAL CHARACTERISTICS

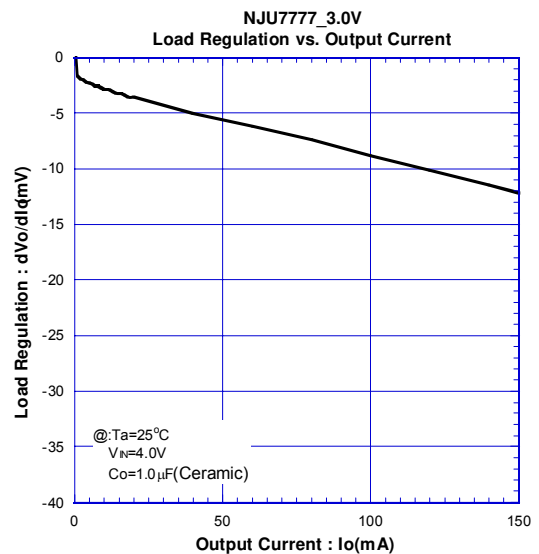
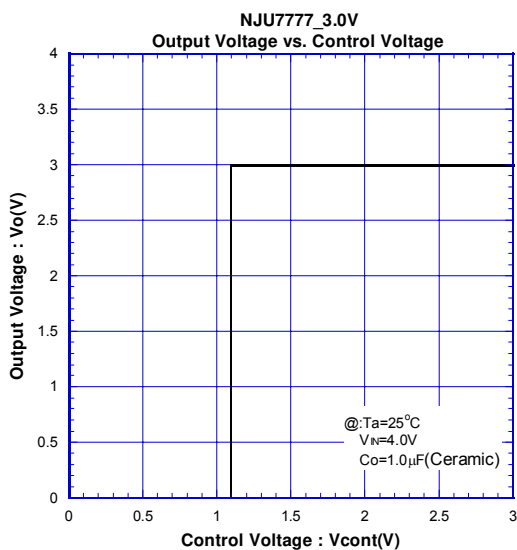
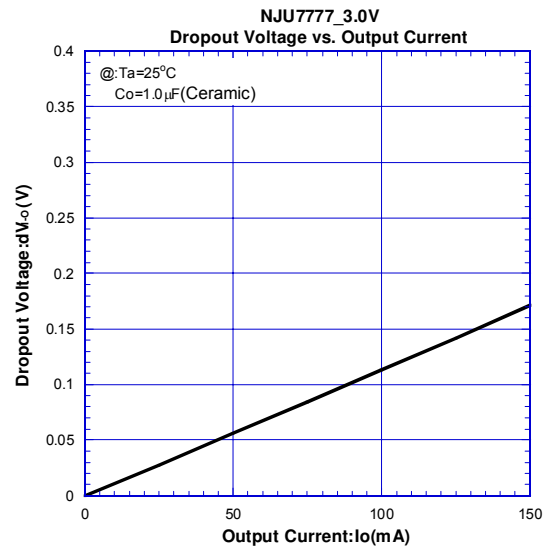
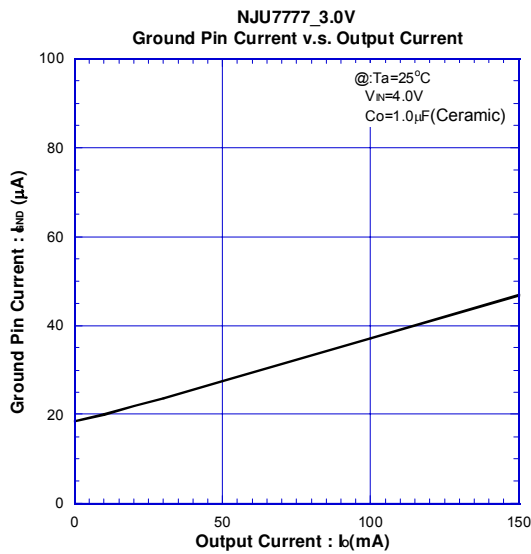
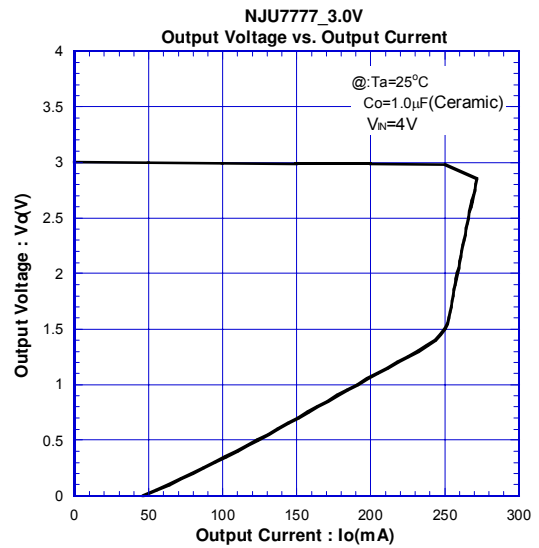
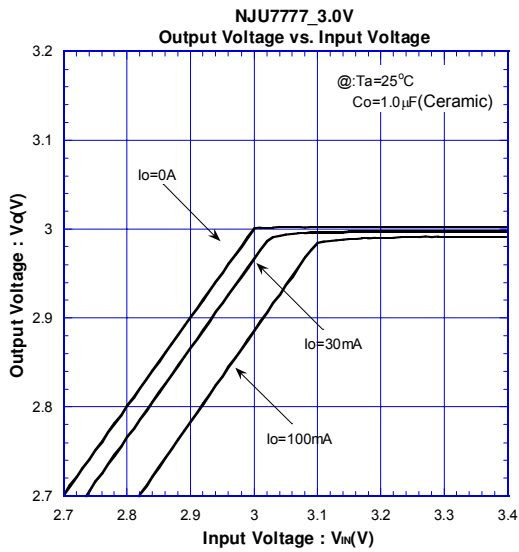

NJU7777

■ TYPICAL CHARACTERISTICS

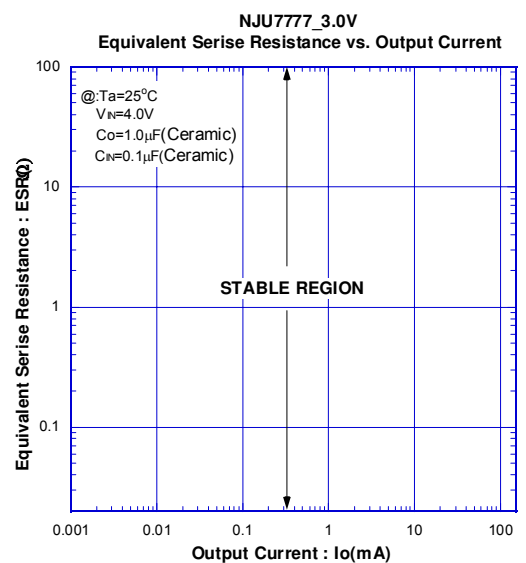
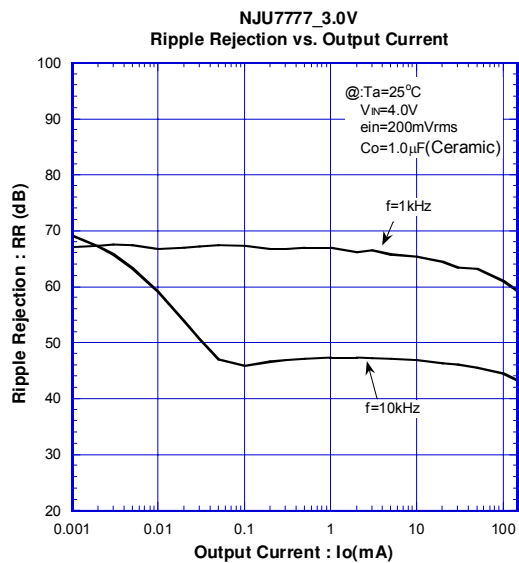
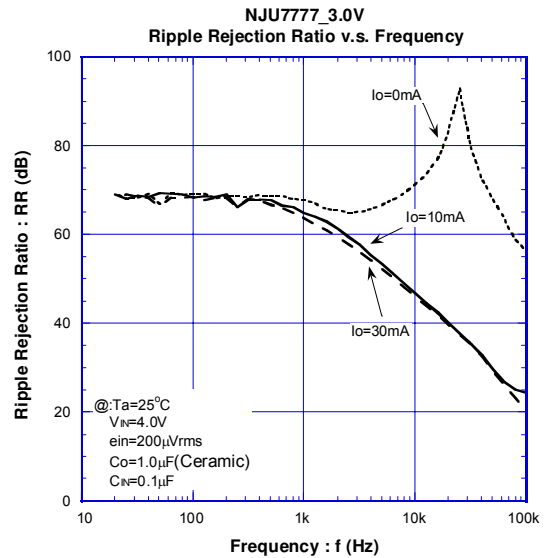
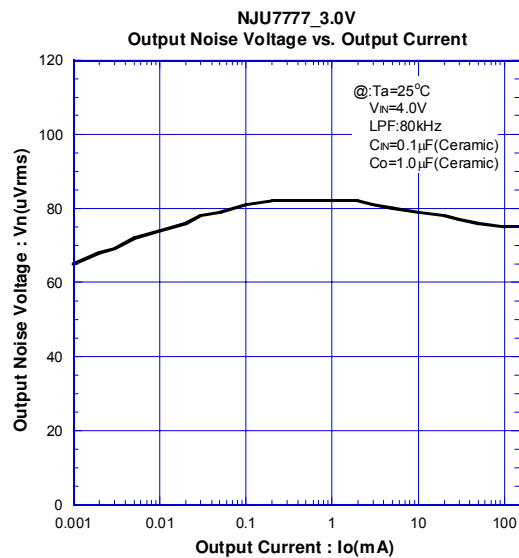
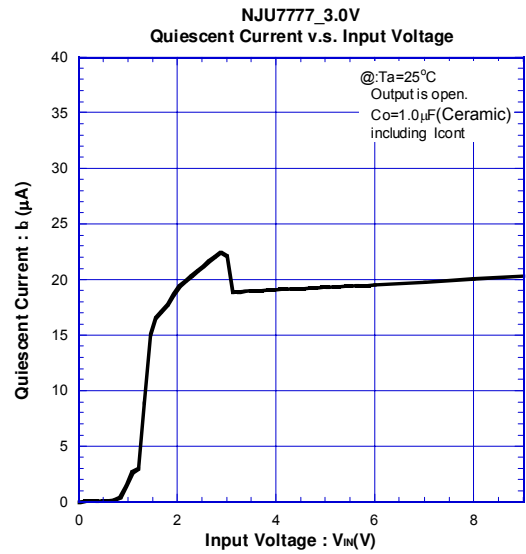
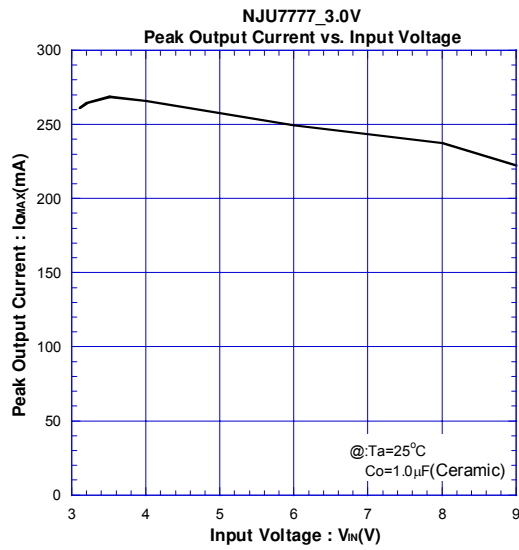

■ TYPICAL CHARACTERISTICS

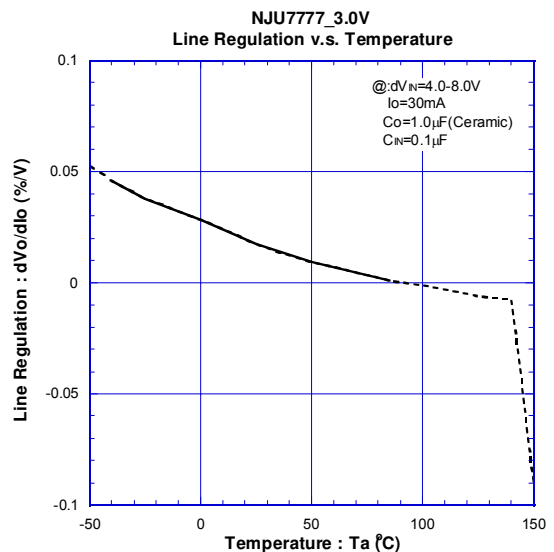
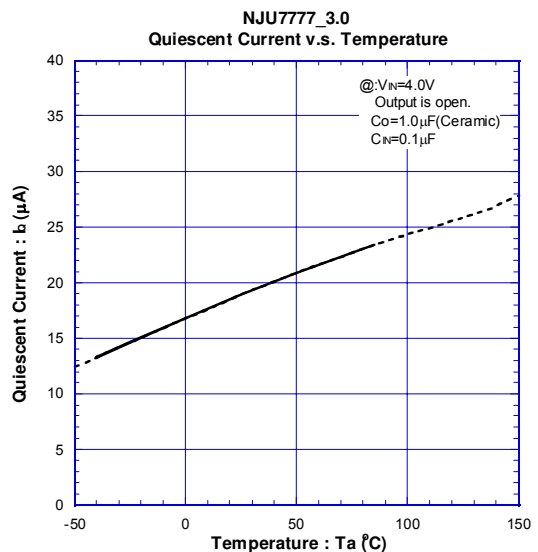
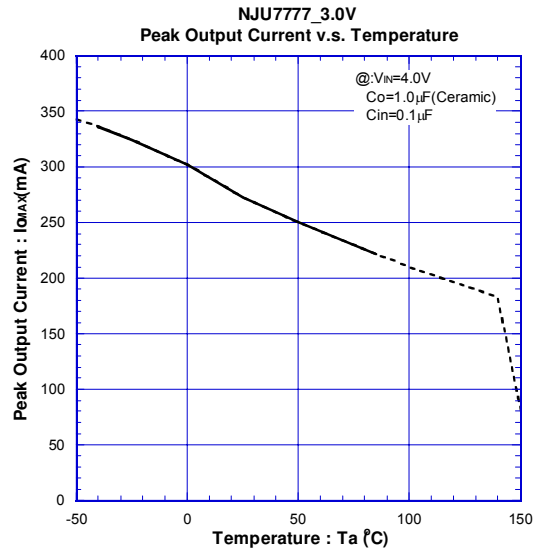
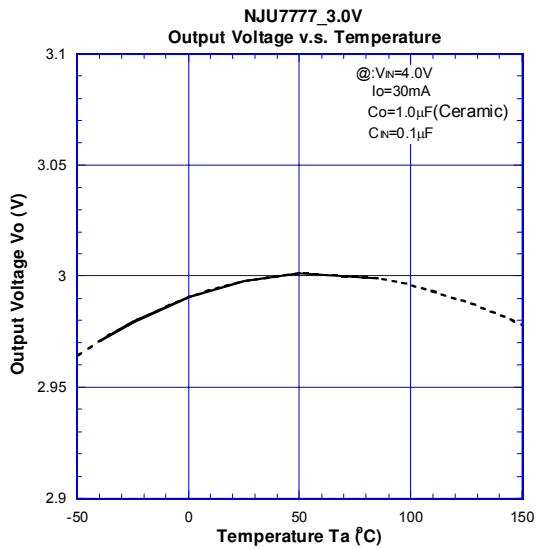
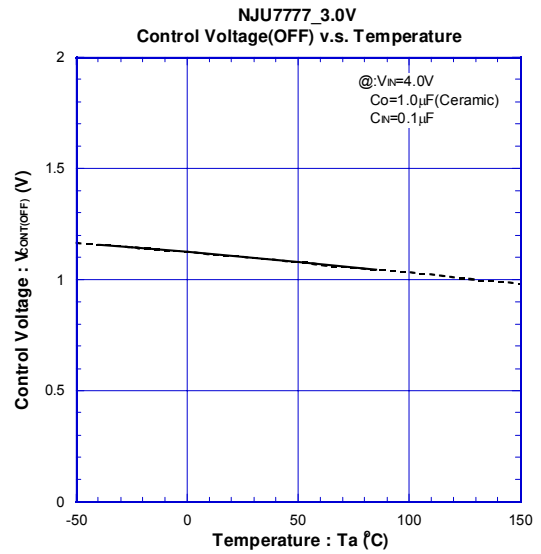
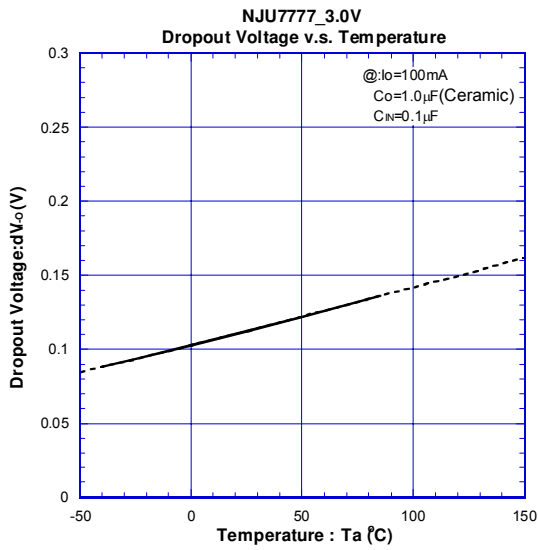

■ TYPICAL CHARACTERISTICS

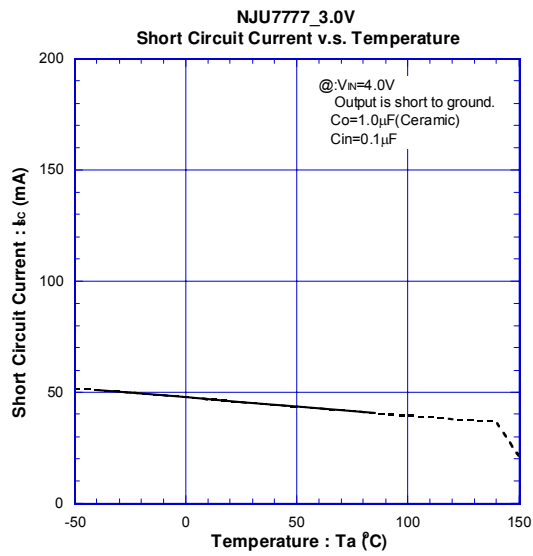
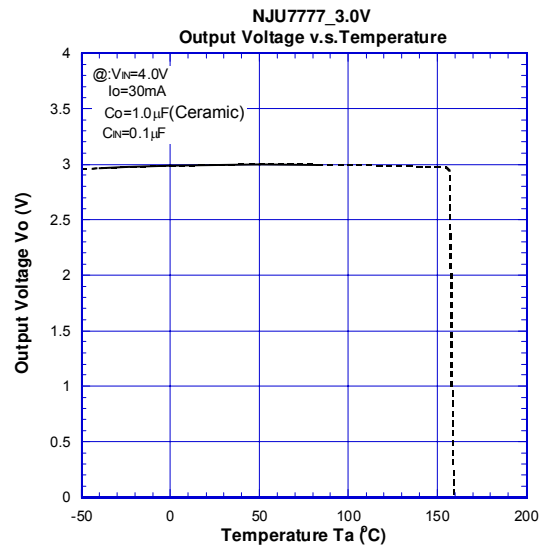
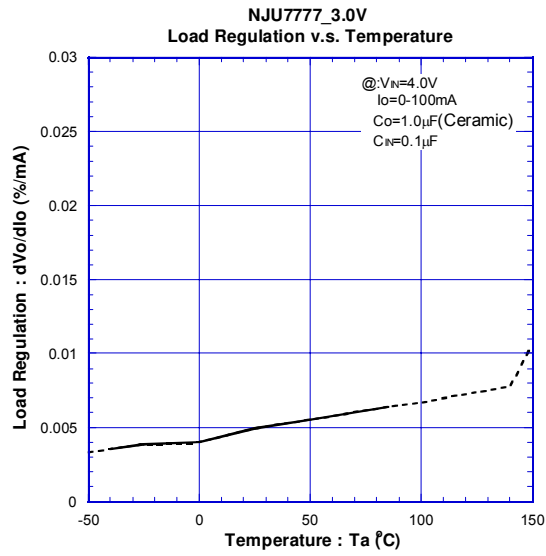

■ TYPICAL CHARACTERISTICS

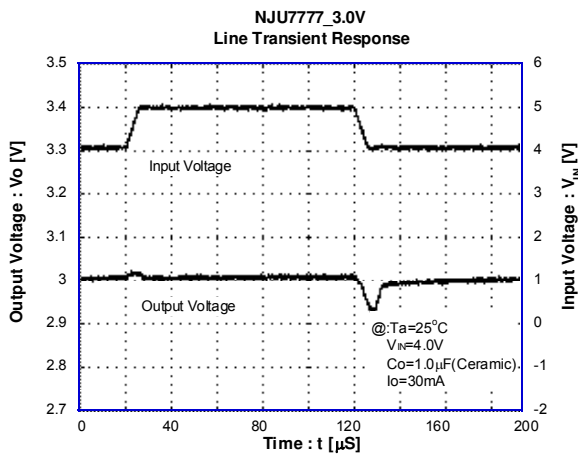
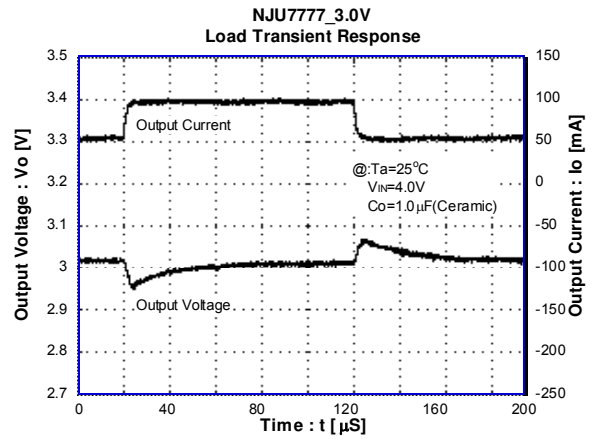
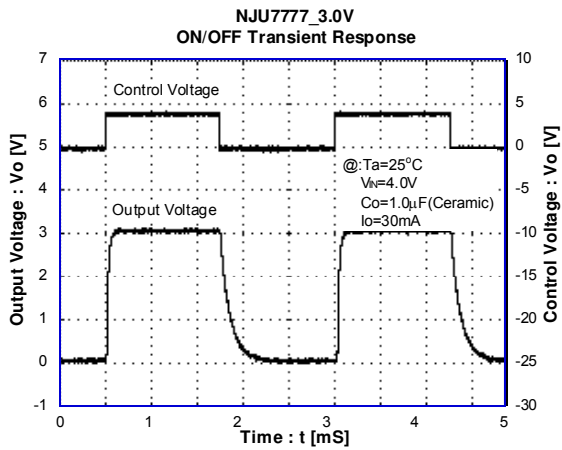

[CAUTION]
The specifications on this databook are only given for information, without any guarantee as regards either mistakes or omissions. The application circuits in this databook are described only to show representative usages of the product and not intended for the guarantee or permission of any right including the industrial rights.