

MATERIALS AND FINISHES:

BODY: ZINC/BRASS
PLATED NICKEL

CENTER CONTACT: BRASS
PLATED GOLD

OUTER CASING: PLASTIC
KEYING: SEE TABLE
COLOR: SEE TABLE

INSULATOR: TEFLON

RETENTION SPECIFICATION:
THE FAKRA CONNECTOR WILL WITHSTAND
A LONGITUDINAL FORCE OF 110 N(24.75 LBS)

FAKRA
CONNECTOR
KEYING
CODE D

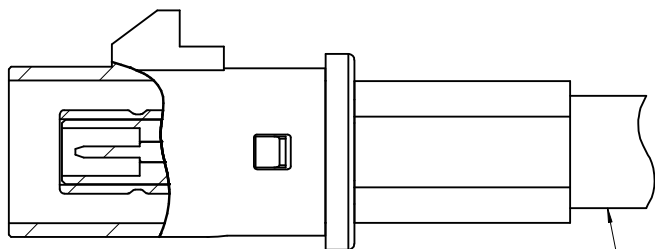

RG58 CABLE

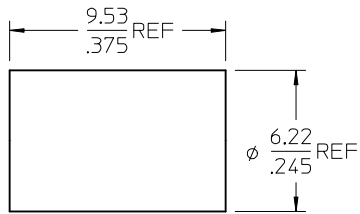
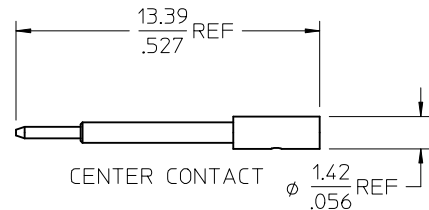
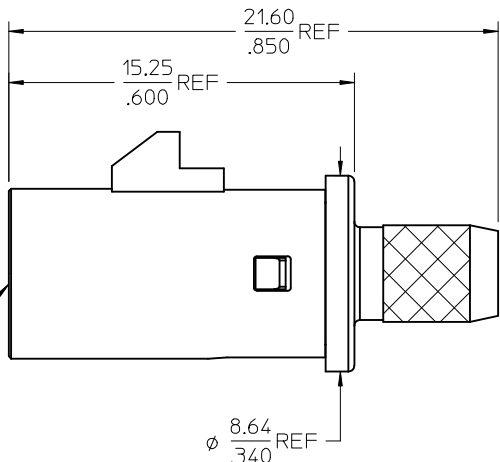
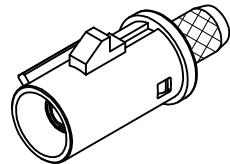

CRIMP TUBE

AS-89678-750	ASSEMBLY INSTRUCTIONS
MIL-STD-348A, FIG. 311.1	INTERFACE
SPECIFICATION	DESCRIPTION

CHG: REDREW IN SD
CHANGED ALL DIMS
FROM IN/MM TO MM/IN
ADDED P/N
73404-0581 THRU
-0583
ADDED RIGHT VIEW
TO SHEET 1
ADDED SHEET 2
AND 3

EC NO: URF2007-0200
DRAWN BY: DRWINTELALHERY 2006/11/10
CHKD:SSHAH 2006/11/10
APPR:WIENER 2006/11/10

QUALITY SYMBOLS

 DESCRIPTION
 REV

GENERAL TOLERANCES (UNLESS SPECIFIED)

	mm	INCH
4 PLACES	± .005	± .0005
3 PLACES	± .003	± .0003
2 PLACES	± .002	± .0002
1 PLACE	± .001	± .0001

ANGULAR ± 2 °

DRAFT WHERE APPLICABLE
MUST REMAIN
WITHIN DIMENSIONS

DIMENSION STYLE
MM/IN

DRAWN BY	DATE
SSS	2001/07/20
CHECKED BY	DATE
TEF	2001/07/20
APPROVED BY	DATE
GMH	2001/07/20

MATERIAL NO.
SEE SHEET 3

SCALE
DESIGN UNITS
METRIC

THIRD ANGLE PROJECTION

TITLE
SMB JACK, STR, RG58,
FAKRA, 50 OHMS
SMB-JC

MOLEX INCORPORATED

DOCUMENT NO.
SD-73404-057

SHEET NO.
1 OF 3

THIS DRAWING CONTAINS INFORMATION THAT IS PROPRIETARY TO MOLEX INCORPORATED AND SHOULD NOT BE USED WITHOUT WRITTEN PERMISSION

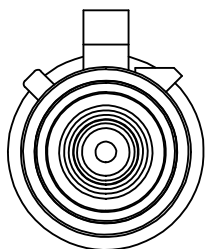

CODE - A

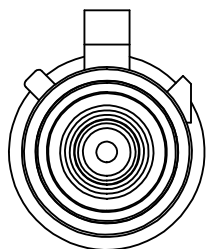

CODE - B

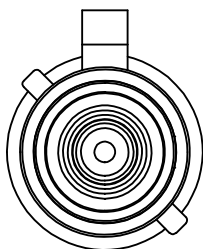

CODE - C

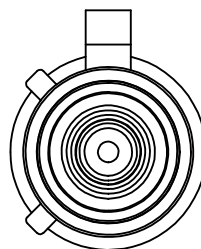

CODE - D

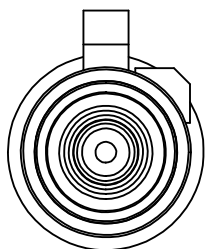

CODE - E

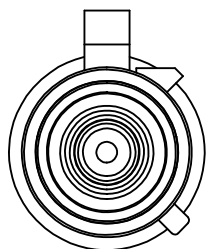

CODE - F

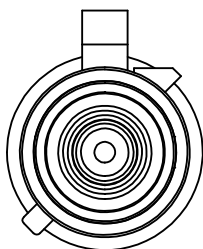

CODE - G

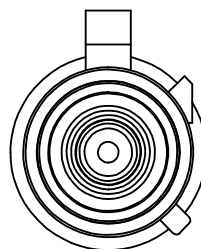

CODE - H

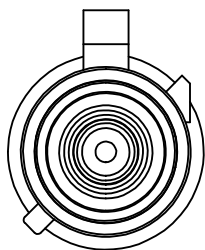

CODE - I

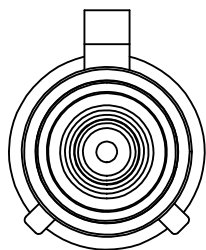

CODE - K

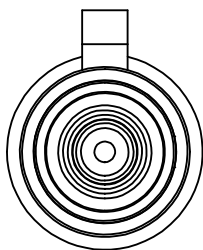

CODE - Z

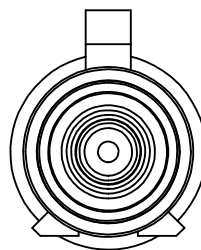

CODE - L

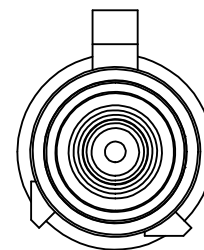

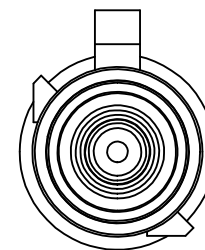

CODE - M



CODE - N

CHG: SEE SHEET 1
 EC NO: URF2007-0200
 DRWN:FLAHERTY 2006/11/10
 CHKD:SSHAH 2006/11/10
 APPR:JWIENER 2006/11/10

QUALITY SYMBOLS
 = 0
 = 0

GENERAL TOLERANCES (UNLESS SPECIFIED)

	mm	INCH
4 PLACES	± .005	± .0004
3 PLACES	± .005	± .0004
2 PLACES	± .005	± .0004
1 PLACE	± .005	± .0004

ANGULAR ± 2 °

DRAFT WHERE APPLICABLE
 MUST REMAIN
 WITHIN DIMENSIONS

DIMENSION STYLE
MM/IN

DRAWN BY	DATE
SSS	2001/07/20
CHECKED BY	DATE
TEF	2001/07/20
APPROVED BY	DATE
GMH	2001/07/20

MATERIAL NO.
SEE SHEET 3

SCALE
METRIC

DESIGN UNITS
METRIC

THIRD ANGLE PROJECTION

TITLE
**SMB JACK, STR, RG58,
 FAKRA, 50 OHMS
 SMB-JC**

 **MOLEX INCORPORATED**

DOCUMENT NO.
SD-73404-057

SHEET NO.
2 OF 3

THIS DRAWING CONTAINS INFORMATION THAT IS PROPRIETARY TO MOLEX INCORPORATED AND SHOULD NOT BE USED WITHOUT WRITTEN PERMISSION

N	PASTEL GREEN	73404-0583
M	PASTEL ORANGE	73404-0582
L	CARMINE RED	73404-0581
Z	WATER BLUE	73404-0580
K	CURRY YELLOW	73404-0579
I	BEIGE	73404-0578
H	VIOLET	73404-0577
G	GRAY	73404-0576
F	BROWN	73404-0575
E	GREEN	73404-0574
D	BORDEAUXVIOLET	73404-0573
C	BLUE	73404-0572
B	CREAM WHITE	73404-0571
A	BLACK	73404-0570
KEYING CODE	COLOR	PART NO.

CHG: SEE SHEET 1 EC NO: URF2007-0200 DRWN: TELAHERTY 2006/11/10 CHKD: SSSHAH 2006/11/10 APPR: JWIENER 2006/11/10	QUALITY SYMBOLS =0 =0	GENERAL TOLERANCES (UNLESS SPECIFIED) <table border="1"> <tr> <td></td> <td>mm</td> <td>INCH</td> </tr> <tr> <td>4 PLACES</td> <td>± ---</td> <td>± ---</td> </tr> <tr> <td>3 PLACES</td> <td>± ---</td> <td>± ---</td> </tr> <tr> <td>2 PLACES</td> <td>± ---</td> <td>± ---</td> </tr> <tr> <td>1 PLACE</td> <td>± ---</td> <td>± ---</td> </tr> </table>		mm	INCH	4 PLACES	± ---	± ---	3 PLACES	± ---	± ---	2 PLACES	± ---	± ---	1 PLACE	± ---	± ---	DIMENSION STYLE MM/IN DRAWN BY DATE SSS 2001/07/20 CHECKED BY DATE TEF 2001/07/20 APPROVED BY DATE GMH 2001/07/20	SCALE DESIGN UNITS METRIC THIRD ANGLE PROJECTION	TITLE SMB JACK, STR, RG58, FAKRA, 50 OHMS SMB-JC
		mm	INCH																	
	4 PLACES	± ---	± ---																	
	3 PLACES	± ---	± ---																	
2 PLACES	± ---	± ---																		
1 PLACE	± ---	± ---																		
DRAFT WHERE APPLICABLE MUST REMAIN WITHIN DIMENSIONS	MATERIAL NO. SEE TABLE	DOCUMENT NO. SD-73404-057	SHEET NO. 3 OF 3																	
SIZE 	THIS DRAWING CONTAINS INFORMATION THAT IS PROPRIETARY TO MOLEX INCORPORATED AND SHOULD NOT BE USED WITHOUT WRITTEN PERMISSION																			
A2																				

MATERIALS AND FINISHES:

BODY: ZINC/BRASS
PLATED NICKEL

CENTER CONTACT: BRASS
PLATED GOLD

OUTER CASING: PLASTIC
KEYING: SEE TABLE
COLOR: SEE TABLE

INSULATOR: TEFLON

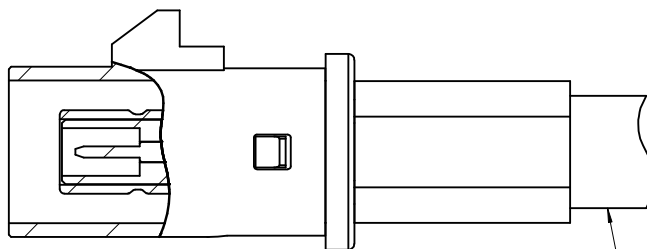

RG58 CABLE

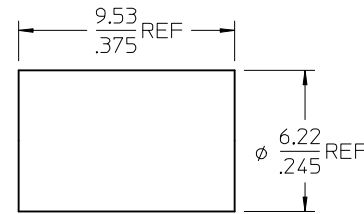
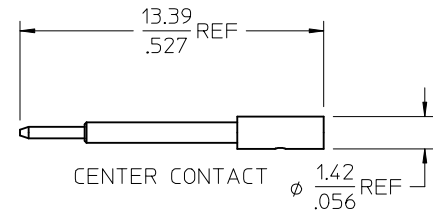
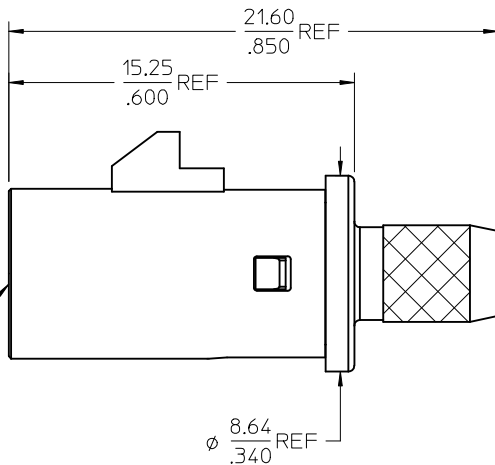
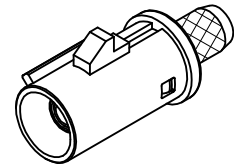

CRIMP TUBE

RETENTION SPECIFICATION:

THE FAKRA CONNECTOR WILL WITHSTAND
A LONGITUDINAL FORCE OF 110 N(24.75 LBS)

FAKRA
CONNECTOR
KEYING
CODE D

AS-89678-750	ASSEMBLY INSTRUCTIONS
MIL-STD-348A, FIG. 311.1	INTERFACE
SPECIFICATION	DESCRIPTION

CHG: REDREW IN SD
CHANGED ALL DIMS
FROM IN/MM TO MM/IN
ADDED P/N
73404-0581 THRU
-0583
ADDED RIGHT VIEW
TO SHEET 1
ADDED SHEET 2
AND 3

EC NO: URF2007-0200
DRAWN BY: DRWINTELALHERY 2006/11/10
CHECKED BY: CHKD:SSHAH 2006/11/10
APPR: WIENER 2006/11/10

QUALITY SYMBOLS

 DESCRIPTION
 REV

GENERAL TOLERANCES (UNLESS SPECIFIED)

	mm	INCH
4 PLACES	± .005	± .0005
3 PLACES	± .003	± .0003
2 PLACES	± .002	± .0002
1 PLACE	± .001	± .0001

ANGULAR ± 2 °

DRAFT WHERE APPLICABLE
MUST REMAIN
WITHIN DIMENSIONS

DIMENSION STYLE
MM/IN

DRAWN BY	DATE
SSS	2001/07/20
CHECKED BY	DATE
TEF	2001/07/20
APPROVED BY	DATE
GMH	2001/07/20

MATERIAL NO.
SEE SHEET 3

SCALE
DESIGN UNITS
METRIC

THIRD ANGLE PROJECTION

TITLE
SMB JACK, STR, RG58,
FAKRA, 50 OHMS
SMB-JC

MOLEX INCORPORATED

DOCUMENT NO.
SD-73404-057

SHEET NO.
1 OF 3

THIS DRAWING CONTAINS INFORMATION THAT IS PROPRIETARY TO MOLEX INCORPORATED AND SHOULD NOT BE USED WITHOUT WRITTEN PERMISSION

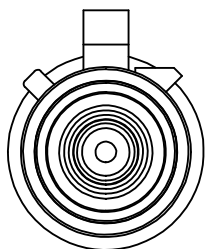

CODE - A

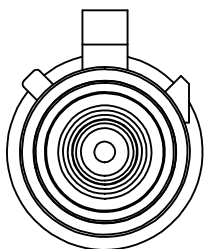

CODE - B

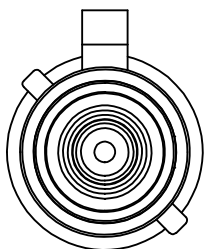

CODE - C

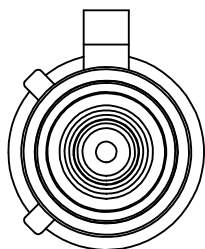

CODE - D

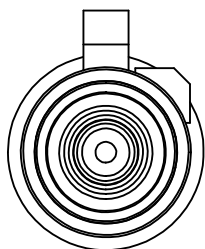

CODE - E

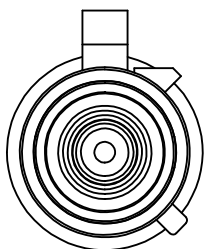

CODE - F

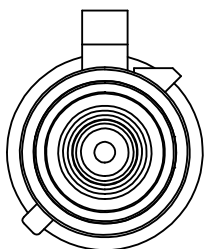

CODE - G

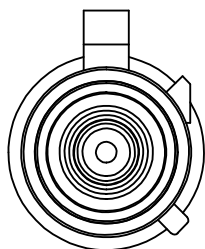

CODE - H

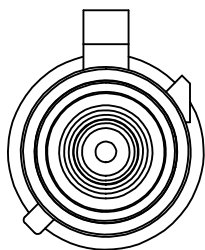

CODE - I

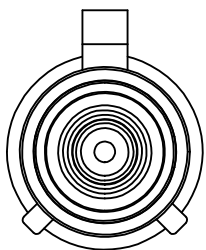

CODE - K

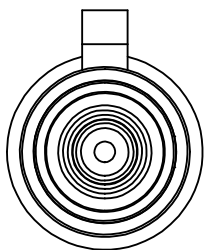

CODE - Z

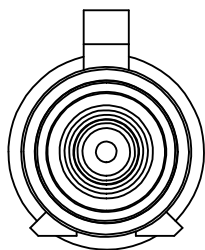

CODE - L

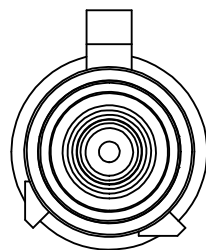

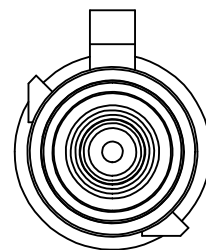

CODE - M



CODE - N

CHG: SEE SHEET 1
 EC NO: URF2007-0200
 DRWN:FLAHERTY 2006/11/10
 CHKD:SSHAH 2006/11/10
 APPR:JWIENER 2006/11/10

QUALITY SYMBOLS
 = 0
 = 0

GENERAL TOLERANCES (UNLESS SPECIFIED)

	mm	INCH
4 PLACES	± .005	± .0005
3 PLACES	± .005	± .0005
2 PLACES	± .005	± .0005
1 PLACE	± .005	± .0005

ANGULAR ± 2 °

DRAFT WHERE APPLICABLE
 MUST REMAIN
 WITHIN DIMENSIONS

DIMENSION STYLE
MM/IN

DRAWN BY	DATE
SSS	2001/07/20
CHECKED BY	DATE
TEF	2001/07/20
APPROVED BY	DATE
GMH	2001/07/20

MATERIAL NO.
SEE SHEET 3

SIZE

SCALE
METRIC

DESIGN UNITS
METRIC

THIRD ANGLE PROJECTION

TITLE
**SMB JACK, STR, RG58,
 FAKRA, 50 OHMS
 SMB-JC**

 **MOLEX INCORPORATED**



DOCUMENT NO.
SD-73404-057

SHEET NO.
2 OF 3

THIS DRAWING CONTAINS INFORMATION THAT IS PROPRIETARY TO MOLEX INCORPORATED AND SHOULD NOT BE USED WITHOUT WRITTEN PERMISSION

N	PASTEL GREEN	73404-0583
M	PASTEL ORANGE	73404-0582
L	CARMINE RED	73404-0581
Z	WATER BLUE	73404-0580
K	CURRY YELLOW	73404-0579
I	BEIGE	73404-0578
H	VIOLET	73404-0577
G	GRAY	73404-0576
F	BROWN	73404-0575
E	GREEN	73404-0574
D	BORDEAUXVIOLET	73404-0573
C	BLUE	73404-0572
B	CREAM WHITE	73404-0571
A	BLACK	73404-0570
KEYING CODE	COLOR	PART NO.

CHG: SEE SHEET 1
 EC NO: URF2007-0200
 DRWN: TELAHERTY 2006/11/10
 CHKD: SSHAH 2006/11/10
 APPR: JWIENER 2006/11/10

QUALITY SYMBOLS
 =0
 =0

GENERAL TOLERANCES (UNLESS SPECIFIED)

	mm	INCH
4 PLACES	± .005	± .0004
3 PLACES	± .005	± .0004
2 PLACES	± .005	± .0004
1 PLACE	± .005	± .0004

ANGULAR ± 2 °

DRAFT WHERE APPLICABLE MUST REMAIN WITHIN DIMENSIONS

DIMENSION STYLE
MM/IN

DRAWN BY DATE
 SSS 2001/07/20

CHECKED BY DATE
 TEF 2001/07/20

APPROVED BY DATE
 GMH 2001/07/20

MATERIAL NO.
SEE TABLE

SIZE

SCALE
 DESIGN UNITS
METRIC

THIRD ANGLE PROJECTION

TITLE
SMB JACK, STR, RG58, FAKRA, 50 OHMS SMB-JC

 **MOLEX INCORPORATED**

DOCUMENT NO.
SD-73404-057

SHEET NO.
3 OF 3

THIS DRAWING CONTAINS INFORMATION THAT IS PROPRIETARY TO MOLEX INCORPORATED AND SHOULD NOT BE USED WITHOUT WRITTEN PERMISSION