

LOC		DIST		REVISIONS			
AD	00	REV	DATE	DATE	DWN	APVD	
		B	REVIS PER ECO-11-025276	04JAN12	KH	DY	

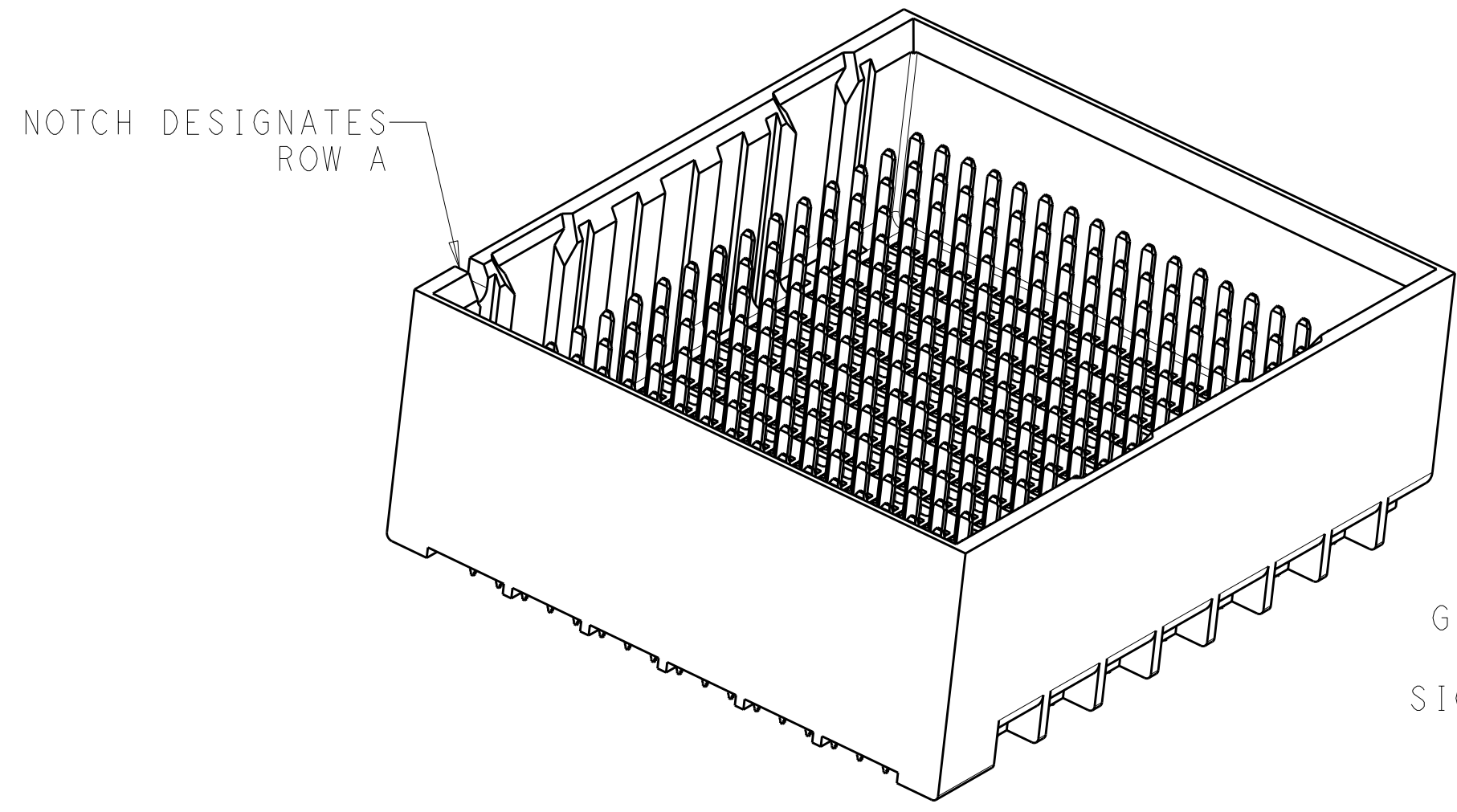

- 1 MATERIAL:
HOUSING: LCP, GLASS FILLED, UL94V-0.
TERMINALS: HIGH PERFORMANCE COPPER ALLOY.
- 2 FINISH:
30μ" MIN GOLD IN CONTACT AREA. SELECTIVE TIN
ON PCB TAILS, NICKEL OVERALL.
- 3 FINISH:
30μ" MIN GOLD IN CONTACT AREA. SELECTIVE TIN-LEAD
ON PCB TAILS, NICKEL OVERALL.

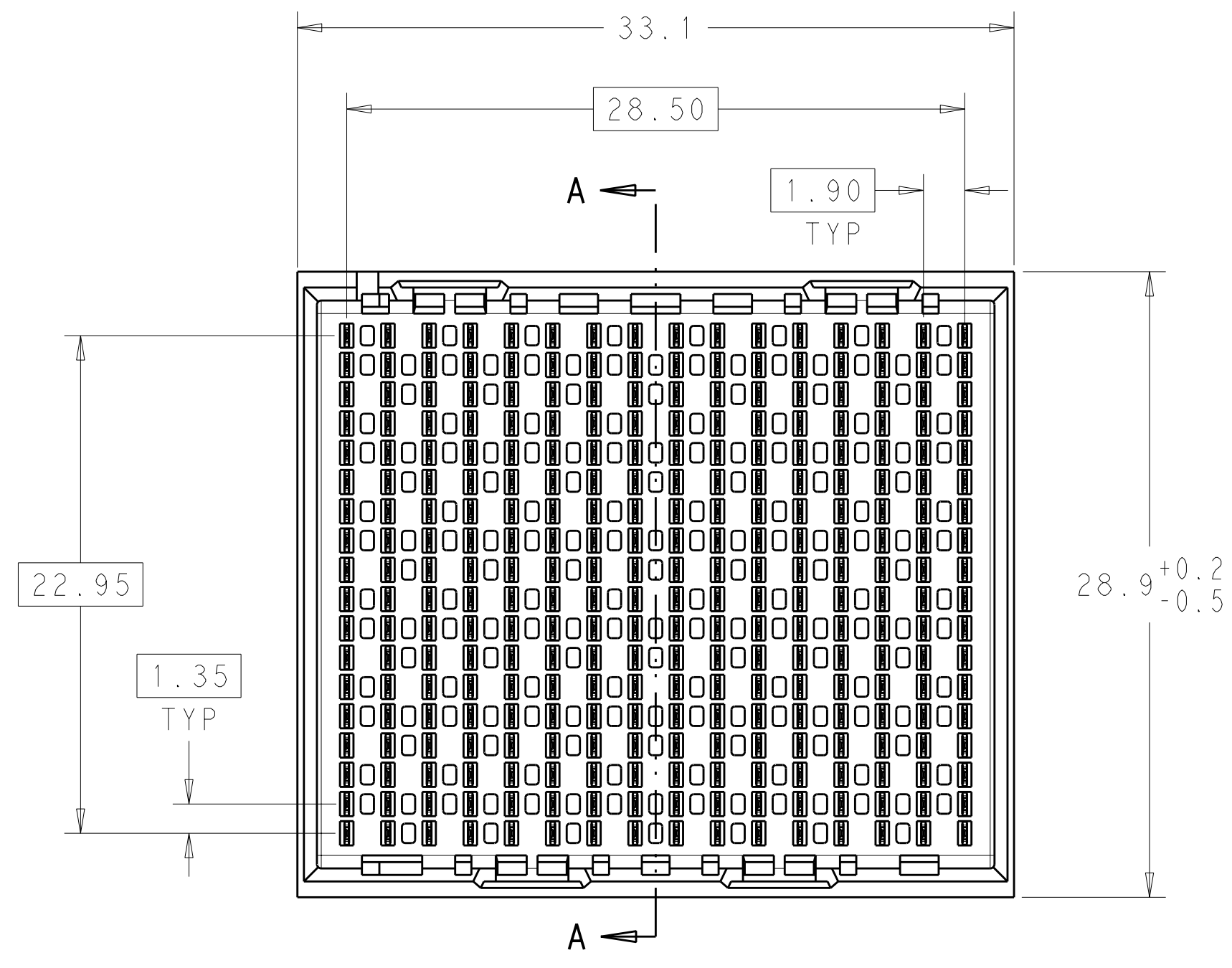
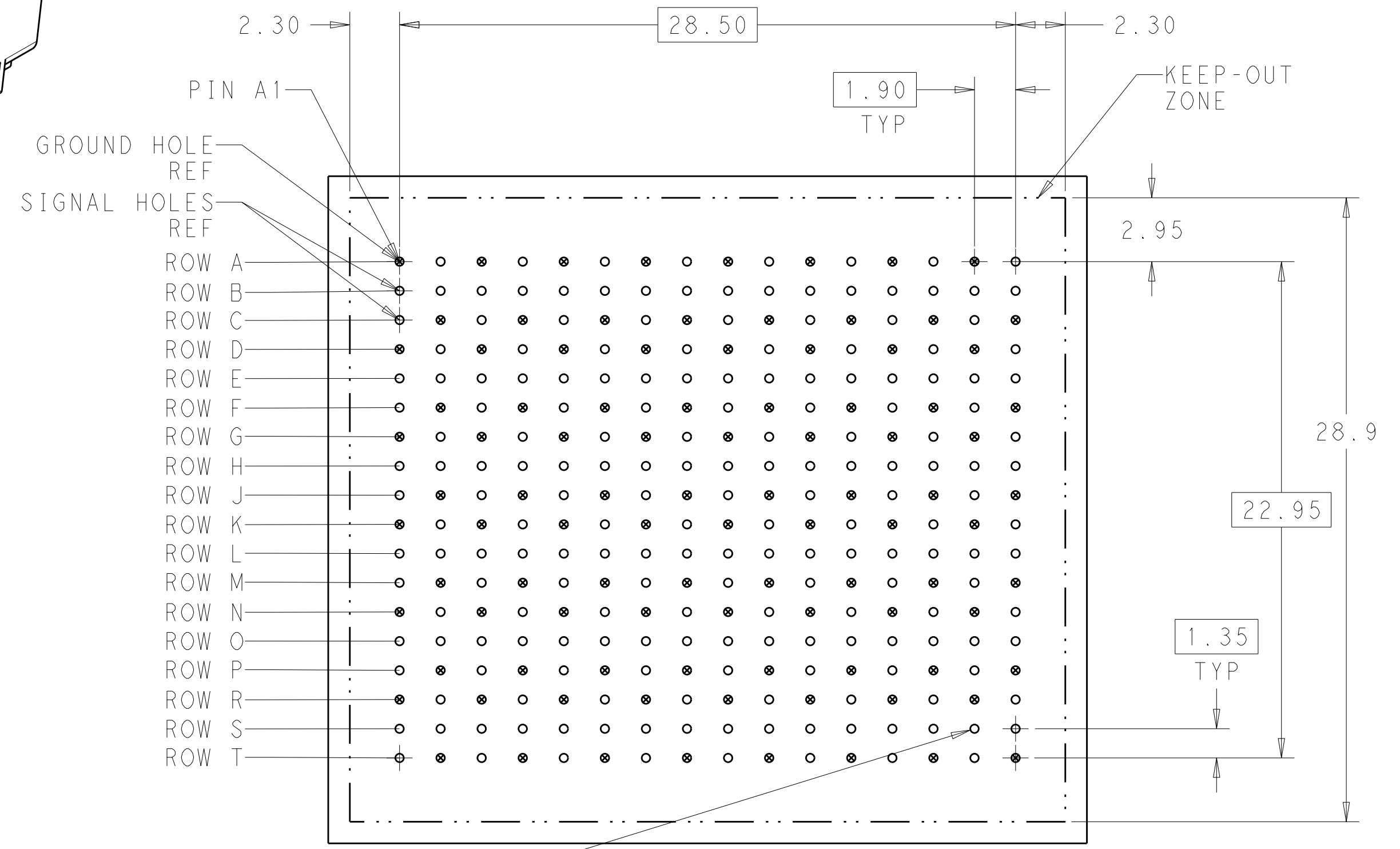

288X Ø0.39±0.05
 Ⓢ Ø0.10
 PLATED THRU HOLE

UNGUIDED
 BACKPLANE HOLE PATTERN
 (CONNECTOR SIDE)

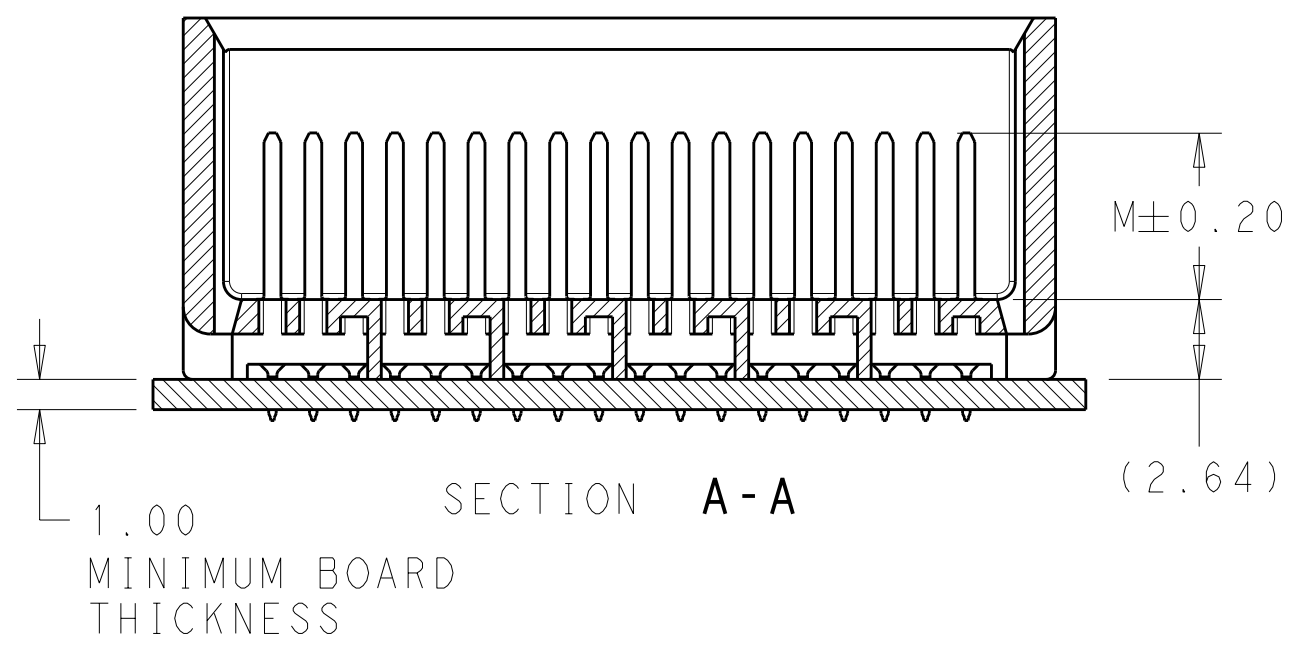
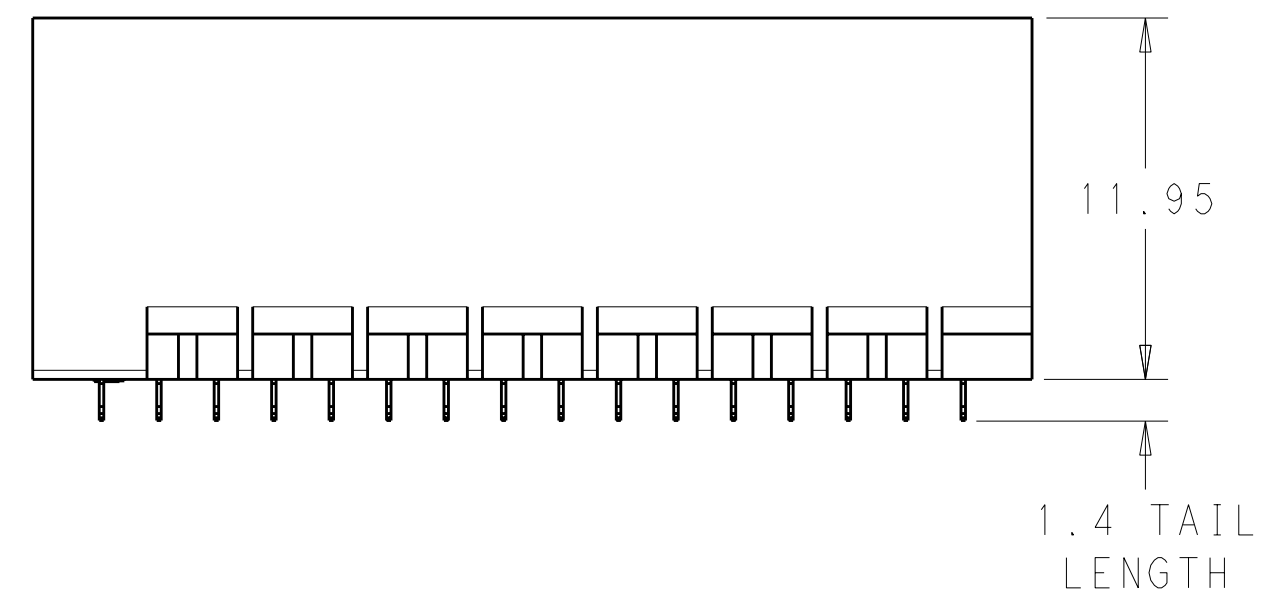

THIS DRAWING IS A CONTROLLED DOCUMENT.		DWN J. K. SHOBER 25JAN2011	TE Connectivity
DIMENSIONS: mm		CHK J. EABY 25JAN2011	
TOLERANCES UNLESS OTHERWISE SPECIFIED:		APVD J. EABY 25JAN2011	NAME IMPACT, 6 PAIR, 16 COLUMN, HEADER
0 PLC ±	1 PLC ±0.25	PRODUCT SPEC	UNGUIDED, DUAL END WALL
2 PLC ±0.13	3 PLC ±	APPLICATION SPEC	SIGNAL MODULE, 0.39 PTH
4 PLC ±	ANGLES ±	WEIGHT	SIZE CAGE CODE DRAWING NO RESTRICTED TO
MATERIAL	FINISH SEE TABLE	CUSTOMER DRAWING	A1100779C=2007902
		SCALE 4:1	SHEET 1 OF 2 REV B

THIS DRAWING IS UNPUBLISHED. RELEASED FOR PUBLICATION 20
 © COPYRIGHT 20 . . . ALL RIGHTS RESERVED.

LOC	DIST	REVISIONS					
AD	00	P	LTB	DESCRIPTION	DATE	DWN	APVD
		-	-	SEE SHEET 1	-	-	-

FINISH	DIM M	PART NUMBER
\triangle_3	5.5	2007902-6
\triangle_3	4.9	2007902-5
\triangle_3	4.5	2007902-4
\triangle_2	5.5	2007902-3
\triangle_2	4.9	2007902-2
\triangle_2	4.5	2007902-1

REFER TO WWW.TE.COM
FOR PRODUCT AVAILABILITY

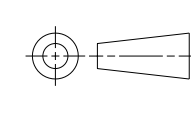
THIS DRAWING IS A CONTROLLED DOCUMENT.		DWN J. K. SHOBER 25JAN2011	 TE Connectivity	
DIMENSIONS: mm		CHK J. EABY 25JAN2011		
		TOLERANCES UNLESS OTHERWISE SPECIFIED: 9 PLC ± 7 PLC ±0.25 5 PLC ±0.13 4 PLC ± ANGLES ± FINISH ±		NAME IMPACT, 6 PAIR, 16 COLUMN, HEADER UNGUIDED, DUAL END WALL SIGNAL MODULE, 0.39 PTH
MATERIAL -		APVD J. EABY 25JAN2011 PRODUCT SPEC - APPLICATION SPEC - WEIGHT - CUSTOMER DRAWING		SIZE CAGE CODE DRAWING NO A100779C=2007902 RESTRICTED TO -
		SCALE 5:1		SHEET 2 OF 2 REV B