



# PLCC4 SMD Top View Package LED SMTL4-BC-RB, RED/BLUE



## Absolute Maximum Ratings

$T_A = 25^\circ\text{C}$  unless otherwise noted

Power Dissipation	Red - 72 mW Blue - 100 mW
Continuous Forward Current	Red - 30 mA Blue - 25 mA
Peak Forward Current <sup>1</sup>	100 mA
Reverse Voltage	5 V
Electrostatic Discharge Classification (HBM)	2000 V
Derating Linear From 25°C	0.4 mA/°C
Operating Temperature Range	-40 ~ +85°C
Storage Temperature Range	-40 ~ +100°C
Soldering Temperature <sup>2</sup>	260°C

Notes: 1. 10% Duty Cycle, Pulse Width  $\leq 0.1$  msec.  
2. Solder time less than 5 seconds at temperature extreme.

## Electrical Characteristics

$T_A = 25^\circ\text{C}$  &  $I_F = 20$  mA unless otherwise noted

Emitting Color	Forward Voltage (V) <sup>1</sup>		Recommend Forward Current (mA)	Reverse Current ( $\mu\text{A}$ ) $V_R=5\text{V}$	Dominant Wavelength (nm) <sup>2</sup>	Luminous Intensity (mcd) <sup>3</sup>		Viewing Angle $2\theta_{1/2}$ (deg)
	TYP	MAX	TYP	MAX	TYP	MIN	TYP	TYP
Red	1.85	2.3	20	10	640	18	36	120
Blue	3.3	4.2	20	10	466	20	50	

Notes: 1. Tolerance of Forward Voltage :  $\pm 0.05\text{V}$ .  
2. Tolerance of Dominant Wavelength :  $\pm 0.1\text{nm}$ .  
3. Tolerance of Luminous Intensity :  $\pm 15\%$ .

## Directivity Radiation

$T_A = 25^\circ\text{C}$  unless otherwise noted

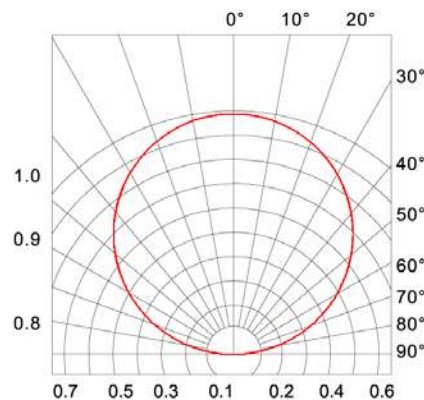

Radiation Diagram

Bivar reserves the right to make changes at any time without notice.

# PLCC4 SMD Top View Package LED SMTL4-BC-RB, RED/BLUE



## Typical Electrical / Optical Characteristics Curves

$T_A = 25^\circ\text{C}$  unless otherwise noted

Relative Spectrum Emission  $I_{rel} = f(\lambda)$ ,  $T_A = 25^\circ\text{C}$ ,  $I_f = 20\text{ mA}$   
 $V(\lambda)$  = Standard eye response curve

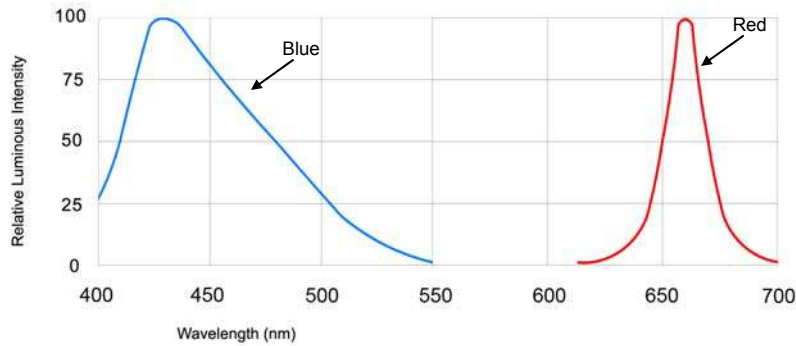

Fig.1 Relative Luminous Intensity vs. Wavelength

Relative Luminous Intensity  $I_v/I_v(20\text{ mA}) = f(I_f)$   
 $T_A = 25^\circ\text{C}$

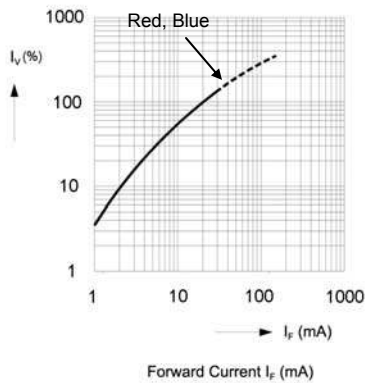

Fig.2 Relative Luminous Intensity vs. Forward Current

Ambient Temperature vs. Allowable Forward Current

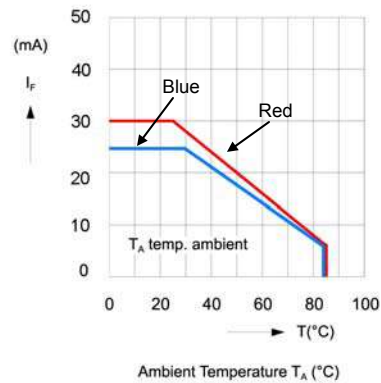

Fig.3 Forward Current vs. Ambient Temperature

Forward Current  $I_f = f(V_f)$   
 $T_A = 25^\circ\text{C}$

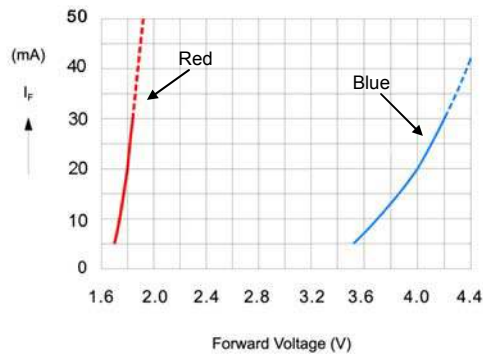

Fig.4 Forward Current vs. Forward Voltage

Bivar reserves the right to make changes at any time without notice.

# PLCC4 SMD Top View Package LED SMTL4-BC-RB, RED/BLUE



## Recommended Soldering Conditions

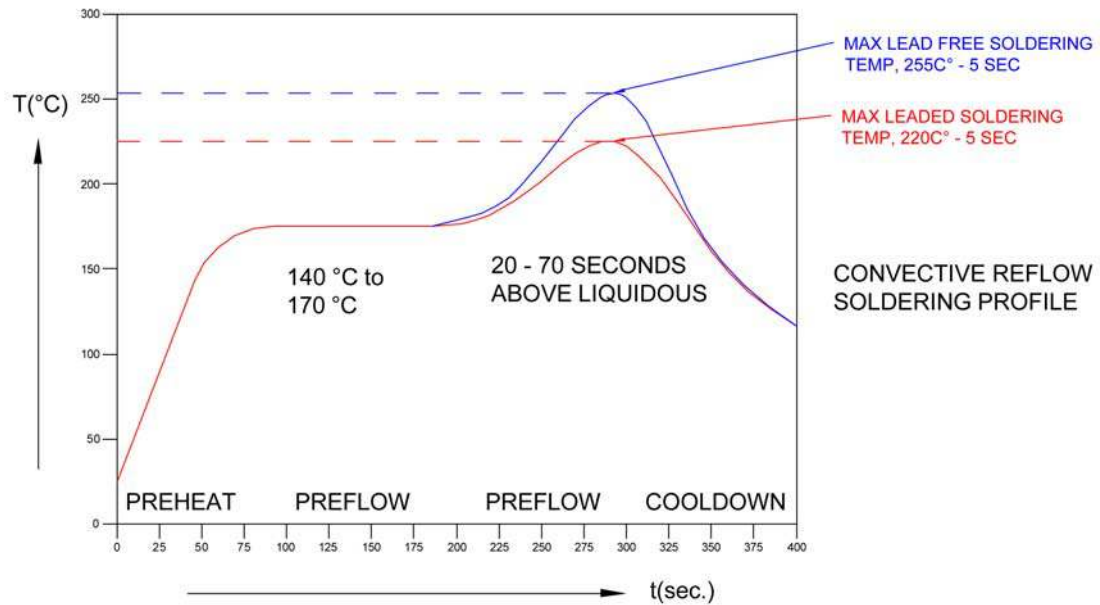

## Tape and Reel Dimensions

Note: 2000 pcs/Reel

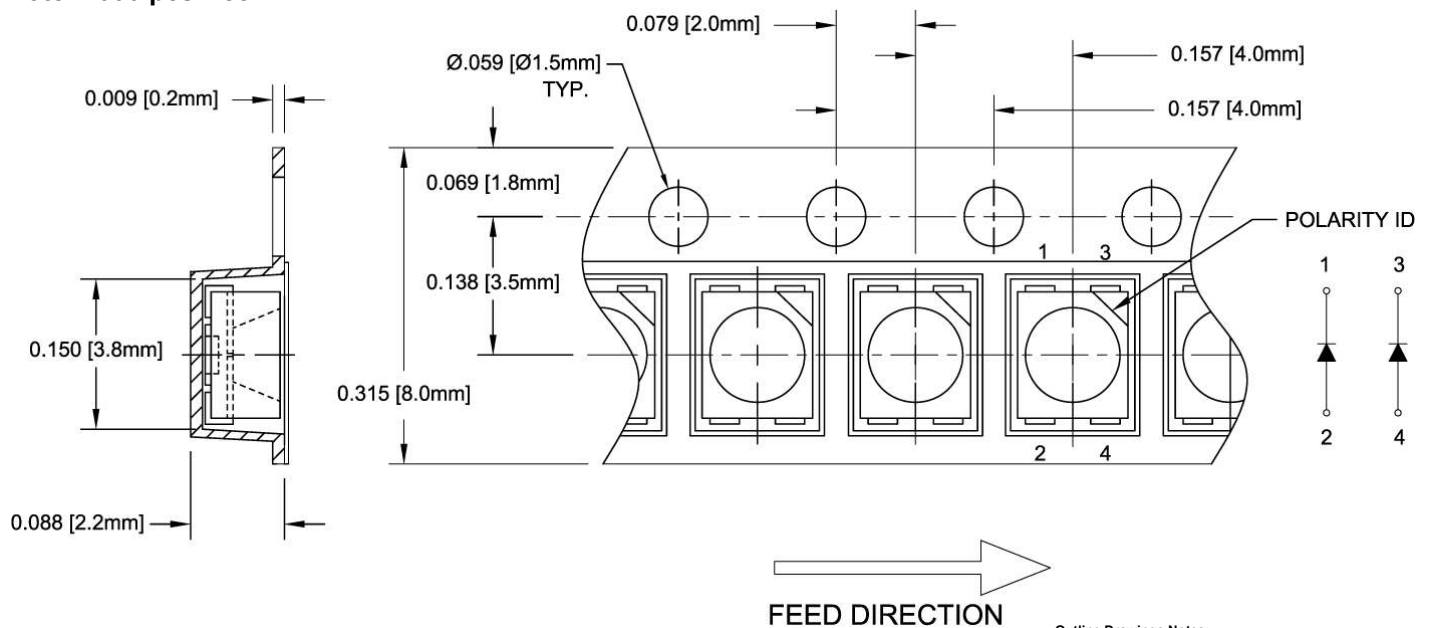

Outline Drawings Notes:  
 1. All dimensions are in inches [millimeters].  
 2. Standard tolerance:  $\pm 0.010$  unless otherwise noted.

Bivar reserves the right to make changes at any time without notice.

# PLCC4 SMD Top View Package LED SMTL4-BC-RB, RED/BLUE

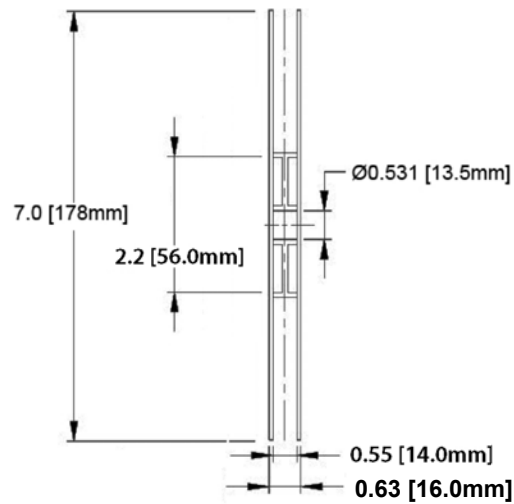
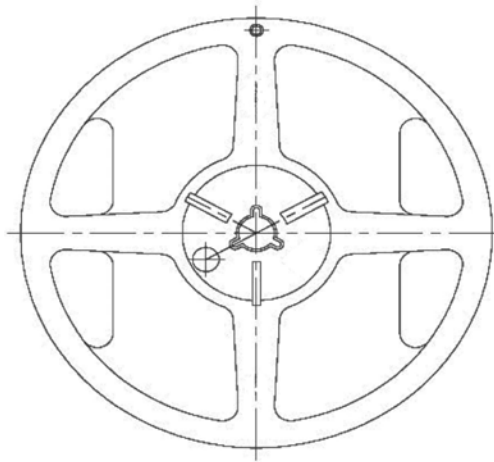

### Outline Drawings Notes:

1. All dimensions are in inches [millimeters].
2. Standard tolerance unless otherwise noted: X.XXX ± 0.010"  
X.X ± 0.1"

## Packaging and Labeling Plan

Note: 1 Reel / Bag

Sealed ESD and Moisture Barrier Bag

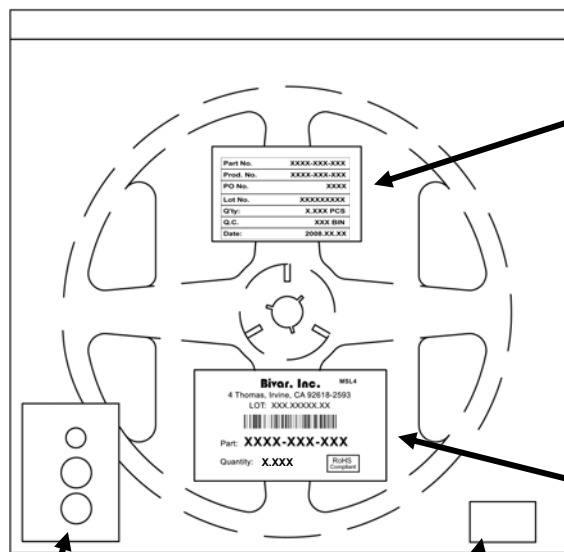

Humidity Indicator Card

Desiccant

Part No.	XXXX-XXX-XXX
Prod. No.	XXXX-XXX-XXX
PO No.	XXXX
Lot No.	XXXXXXXXXX
Q'ty:	X.XXX PCS
Q.C.	XXX BIN
Date:	2008.XX.XX

Internal Quality Control Label



Bivar Standard Packaging Label

Bivar reserves the right to make changes at any time without notice.