

### Features

- 3.0 X 1.0 X 1.5mm right angle SMD LED
- Ideal for indication on hand held products
- Low current operation
- Standard Package: 2,000pcs/ Reel
- MSL (Moisture Sensitivity Level): 3
- RoHS compliant



**ATTENTION**  
OBSERVE PRECAUTIONS  
FOR HANDLING  
ELECTROSTATIC  
DISCHARGE  
SENSITIVE  
DEVICES

### Package Schematics

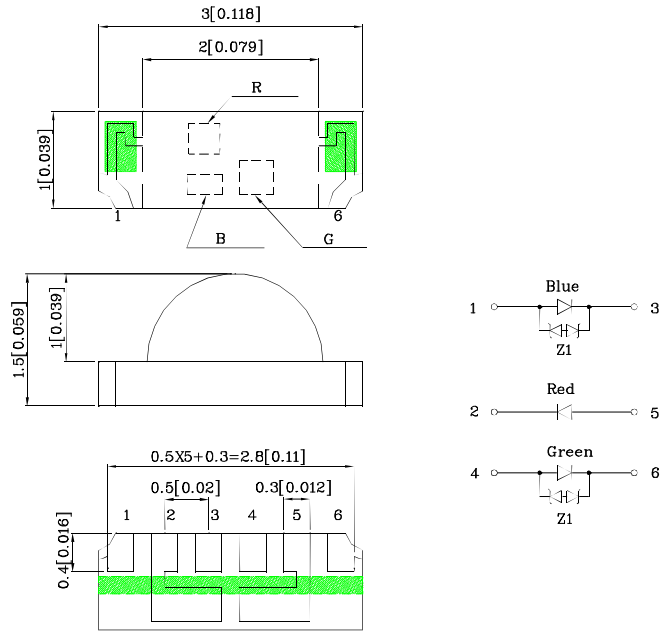

#### Notes:

1. All dimensions are in millimeters (inches).
2. Tolerance is  $\pm 0.2(0.008)$  unless otherwise noted.
3. Specifications are subject to change without notice.

Part Number	Emitting Color	Emitting Material	Lens-color	Luminous Intensity CIE127-2007* ( $I_F=20mA$ ) mcd		$I_v$ (mcd) [2] @B:R:G=16.5mA: 12.2mA:20mA	Dice Chroma- ticity Coordinates		Wavelength CIE127-2007* nm $\lambda_P$	Viewing Angle 2 $\theta$ 1/2
				min.	typ.		X(Typ.)	Y(Typ.)		
XZFBZEBM2DGZ157W	Blue	InGaN	Water Clear	80*	148*	1335*	0.3	0.3	465*	150°
	Red	AlGaInP		400*	657*				631*	
	Green	InGaN		500*	775*				520*	

\*Luminous intensity value and wavelength are in accordance with CIE127-2007 standards.

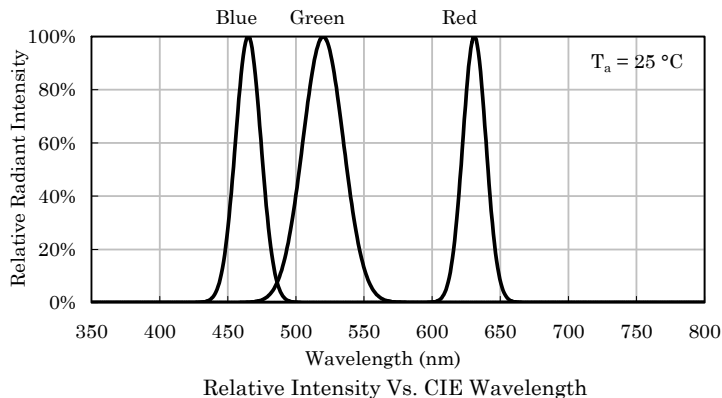

**Electrical / Optical Characteristics at T<sub>A</sub>=25°C**

Parameter	Condition	Symbol	Value			Unit
			Blue	Red	Green	
Wavelength at Peak emission CIE127-2007*	I <sub>F</sub> =20mA	λ <sub>peak</sub>	465*	631*	520*	nm
Dominant Wavelength CIE127-2007*	I <sub>F</sub> =20mA	λ <sub>dom</sub>	470*	624*	525*	nm
Spectral bandwidth at 50%Φ <sub>REL MAX</sub>	I <sub>F</sub> =20mA	Δλ	22	20	35	nm
Forward Voltage	I <sub>F</sub> =20mA	V <sub>F</sub> [typ.] V <sub>F</sub> [max.]	3.3 4	2.1 2.5	3.2 4	V
Reverse Current	V <sub>R</sub> =5V	I <sub>R</sub> [max.]	50	10	50	uA

Note:

\* Wavelength value is in accordance with CIE127-2007 standards.

**Absolute Maximum Ratings at T<sub>A</sub>=25°C**

Parameter	Symbol	Value			Unit
		Blue	Red	Green	
Operating Temperature	Top	-40 To +85			°C
Storage Temperature	T <sub>stg</sub>	-40 To +85			°C
Junction Temperature	T <sub>J</sub>	115	125	115	°C
Power dissipation	P <sub>D</sub>	120	75	120	mW
Total Power dissipation [3]	P total	240			mW
DC Forward Current [1]	I <sub>F</sub>	30	30	30	mA
Peak Forward Current [2]	I <sub>FM</sub>	100	200	100	mA
Reverse Voltage	V <sub>R</sub>	5	5	5	V
Junction/ambient 1 chip on	R <sub>thj-a</sub>	415	325	400	°C/W
Junction/ambient 3 chip on	R <sub>thj-a</sub>	675	460	685	°C/W
Electrostatic Discharge Threshold (HBM)		8000	3000	8000	V

Notes:

1. Single-color light
2. 1/10 Duty Cycle, 0.1ms Pulse Width.
3. Value for total power dissipation when two and more chips are lit simultaneously.
4. A Relative Humidity between 40% and 60% is recommended in ESD-protected work areas to reduce static build up during assembly process (Reference JEDEC/JESD625-A and JEDEC/J-STD-033)

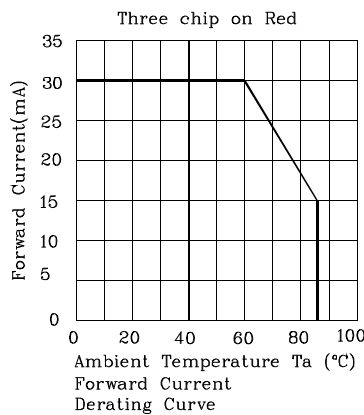
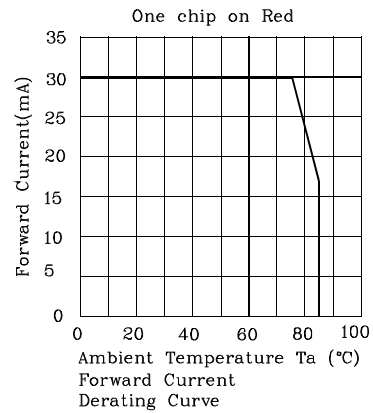
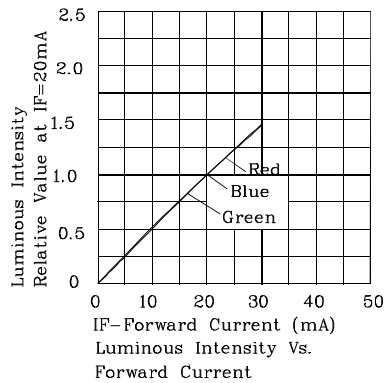
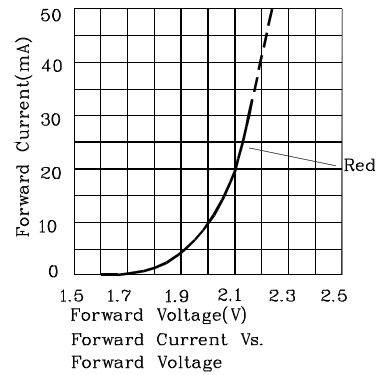
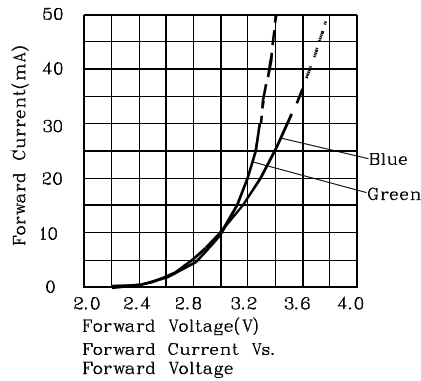
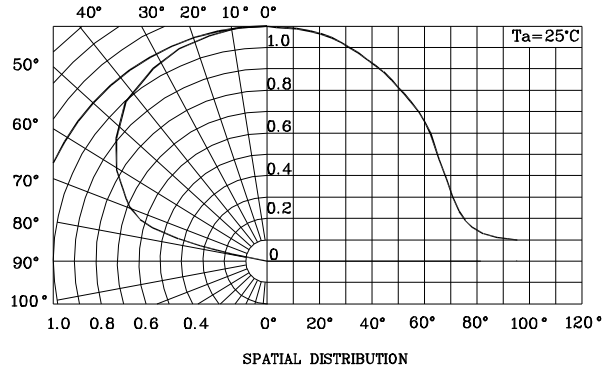

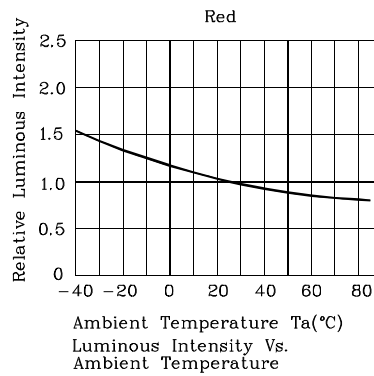
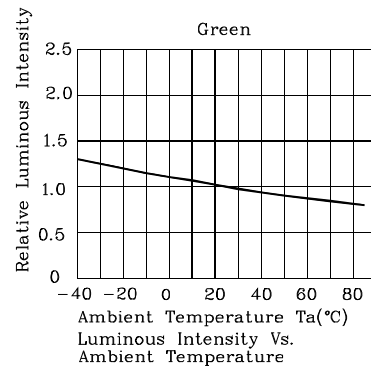
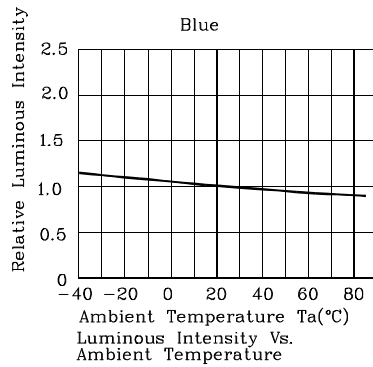
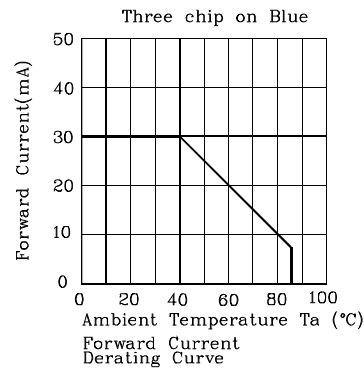
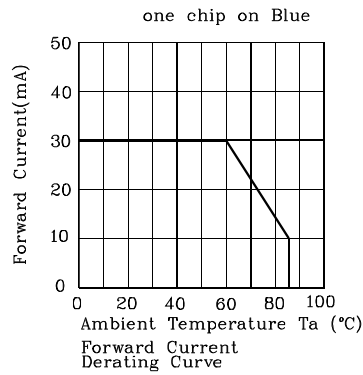
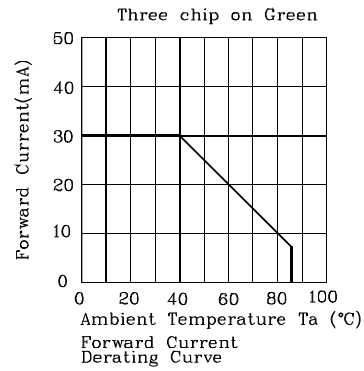
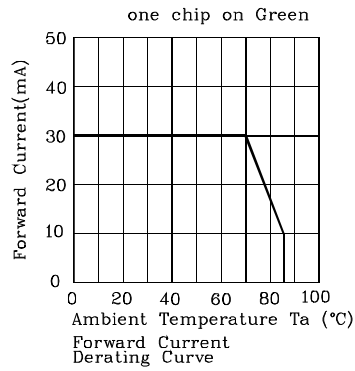

Full color (White Rank)

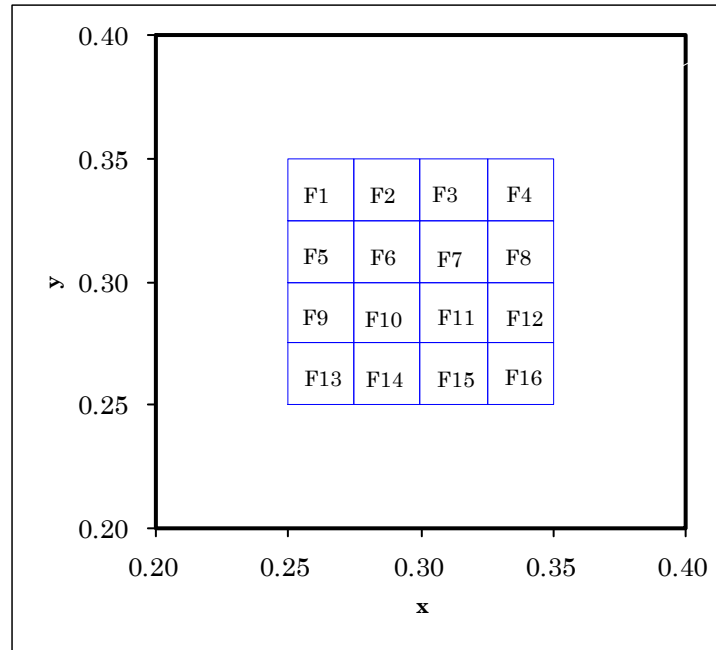

F1		F2		F3		F4	
x	y	x	y	x	y	x	y
0.250	0.325	0.275	0.325	0.300	0.325	0.325	0.325
0.275	0.325	0.300	0.325	0.325	0.325	0.350	0.325
0.275	0.350	0.300	0.350	0.325	0.350	0.350	0.350
0.250	0.350	0.275	0.350	0.300	0.350	0.325	0.350
F5		F6		F7		F8	
x	y	x	y	x	y	x	y
0.250	0.300	0.275	0.300	0.300	0.300	0.325	0.300
0.275	0.300	0.300	0.300	0.325	0.300	0.350	0.300
0.275	0.325	0.300	0.325	0.325	0.325	0.350	0.325
0.250	0.325	0.275	0.325	0.300	0.325	0.325	0.325
F9		F10		F11		F12	
x	y	x	y	x	y	x	y
0.250	0.275	0.275	0.275	0.300	0.275	0.325	0.275
0.275	0.275	0.300	0.275	0.325	0.275	0.350	0.275
0.275	0.300	0.300	0.300	0.325	0.300	0.350	0.300
0.250	0.300	0.275	0.300	0.300	0.300	0.325	0.300
F13		F14		F15		F16	
x	y	x	y	x	y	x	y
0.250	0.250	0.275	0.250	0.300	0.250	0.325	0.250
0.275	0.250	0.300	0.250	0.325	0.250	0.350	0.250
0.275	0.275	0.300	0.275	0.325	0.275	0.350	0.275
0.250	0.275	0.275	0.275	0.300	0.275	0.325	0.275

Notes:  
Shipment may contain more than one chromaticity regions.  
Orders for single chromaticity region are generally not accepted.  
Measurement tolerance of the chromaticity coordinates is  $\pm 0.01$ .

❖ LED is recommended for reflow soldering and soldering profile is shown below.

Reflow Soldering Profile for SMD Products (Pb-Free Components)

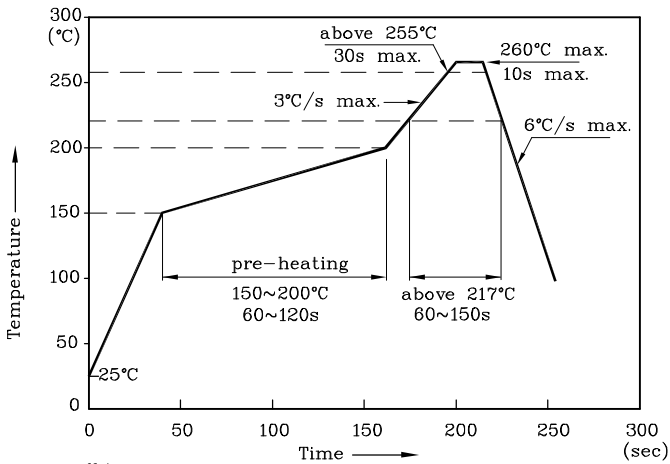

Notes:

1. All temperatures refer to the center of the package, measured on the package body surface facing up during reflow.
2. Do not apply any stress to the LED during high temperature conditions.
3. Maximum number of soldering passes: 2

❖ The device has a single mounting surface. The device must be mounted according to the specifications.

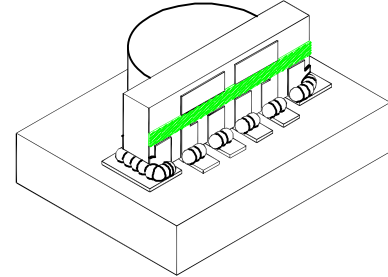

❖ Reel Dimension

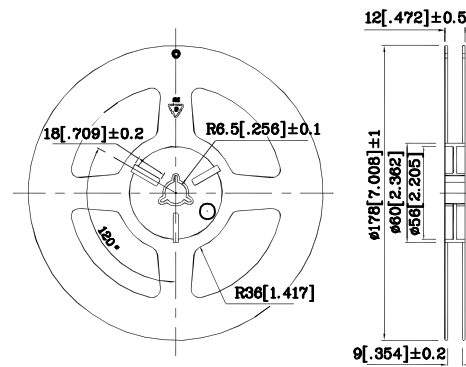

❖ Recommended Soldering Pattern (Units : mm; Tolerance: ± 0.1)

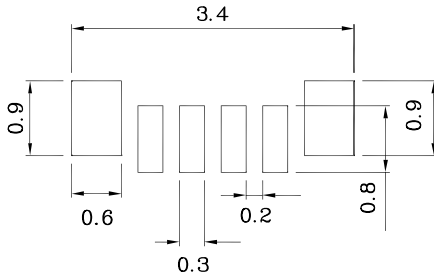

❖ Tape Specification (Units : mm)

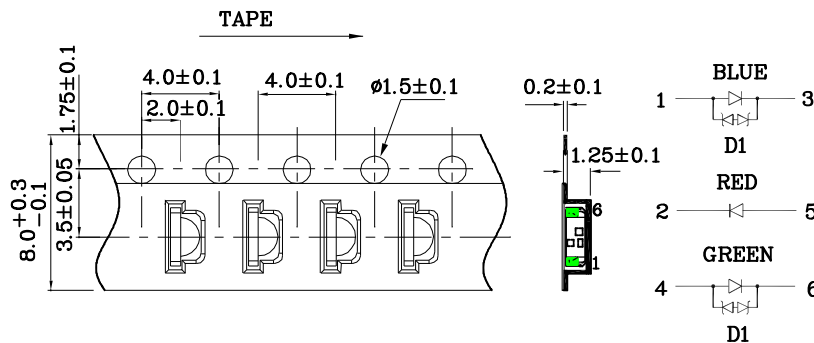

Remarks:

If special sorting is required (e.g. binning based on forward voltage, Luminous intensity / luminous flux, or wavelength), the typical accuracy of the sorting process is as follows:

1. Wavelength: +/-1nm
2. Luminous intensity / luminous flux: +/-15%
3. Forward Voltage: +/-0.1V

Note: Accuracy may depend on the sorting parameters.

**PACKING & LABEL SPECIFICATIONS**

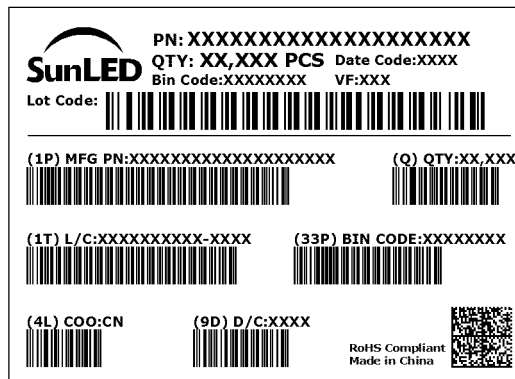
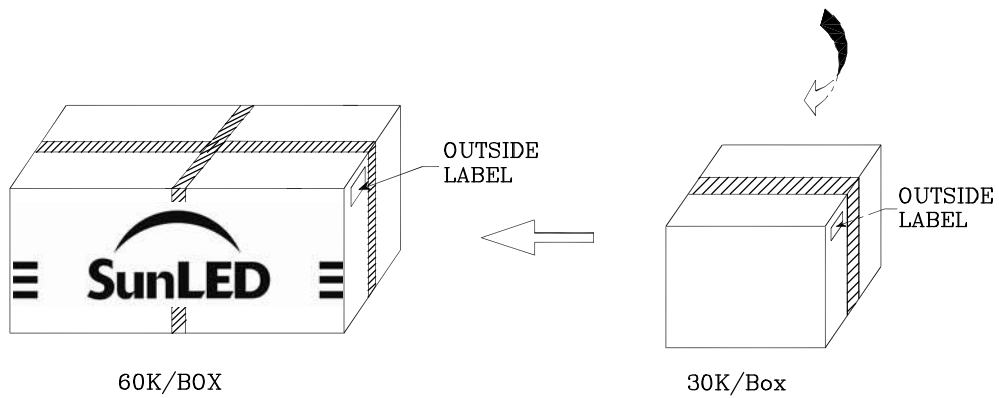
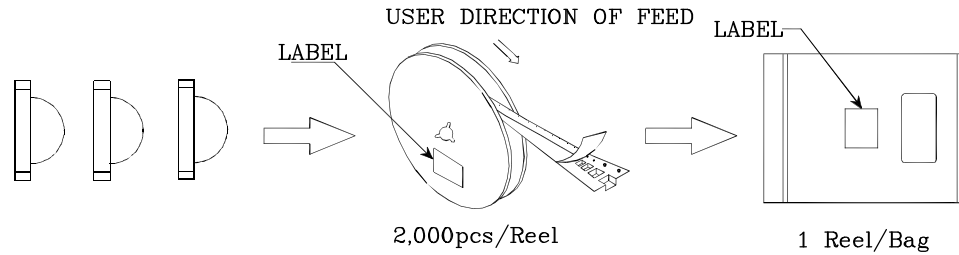

**TERMS OF USE**

1. Data presented in this document reflect statistical figures and should be treated as technical reference only.
2. Contents within this document are subject to improvement and enhancement changes without notice.
3. The product(s) in this document are designed to be operated within the electrical and environmental specifications indicated on the datasheet. User accepts full risk and responsibility when operating the product(s) beyond their intended specifications.
4. The product(s) described in this document are intended for electronic applications in which a person's life is not reliant upon the LED. Please consult with a SunLED representative for special applications where the LED may have a direct impact on a person's life.
5. The contents within this document may not be altered without prior consent by SunLED.
6. Additional technical notes are available at <http://www.SunLEDusa.com/TechnicalNotes.asp>