

GMVSTBW 2,5/11-STF-7,62 EX - PCB connector



1810094

<https://www.phoenixcontact.com/us/products/1810094>

Please be informed that the data shown in this PDF document is generated from our online catalog. Please find the complete data in the user documentation. Our general terms of use for downloads are valid.



PCB connector, nominal cross section: 2.5 mm², color: green, nominal current: 12 A, contact surface: Tin, contact connection type: Socket, number of potentials: 11, number of rows: 1, number of positions: 11, number of connections: 11, product range: GMVSTBW 2,5/..-STF-EX, pitch: 7.62 mm, connection method: Screw connection with tension sleeve, screw head form: L Slotted, conductor/PCB connection direction: -90 °, locking clip: - Locking clip, plug-in system: COMBICON MSTB 2,5 EX, locking: Screw locking mechanism, mounting: Screw flange, type of packaging: packed in cardboard

Your advantages

- Well-known connection principle allows worldwide use
- Satisfies the more stringent safety requirements of "Ex eb" protection according to IEC 60079-7 for potentially explosive areas
- Screwable flange for superior mechanical stability
- Low temperature rise, thanks to maximum contact force

Commercial data

Item number	1810094
Packing unit	1 pc
Minimum order quantity	50 pc
Note	Made to order (non-returnable)
Sales key	AA03
Product key	AACAMK
Catalog page	Page 379 (C-1-2013)
GTIN	4046356706124
Weight per piece (including packing)	29.29 g
Weight per piece (excluding packing)	29.29 g
Customs tariff number	85366990
Country of origin	DE

GMVSTBW 2,5/11-STF-7,62 EX - PCB connector



1810094

<https://www.phoenixcontact.com/us/products/1810094>

Technical data

Product properties

Type	Standard
Product line	COMBICON Connectors M
Product type	PCB connector
Product family	GMVSTBW 2,5/..-STF-EX
Number of positions	11
Pitch	7.62 mm
Number of connections	11
Number of rows	1
Mounting flange	Screw flange
Number of potentials	11

Electrical properties

Nominal current I_N	12 A
Nominal voltage U_N	352 V
Rated current / conductor cross section	12 A/2.5 mm ²
Degree of pollution	3

Ex data

Ex approval

Identification	0344Ⓢ II 2GD / Ex eb IIC Gb
EU-type examination certificate	KEMA 10ATEX0196 U
IECEx certificate	IECEx KEM 10.0093U

Connection data

Connection technology

Type	Standard
Connector system	COMBICON MSTB 2,5 EX
Nominal cross section	2.5 mm ²
Contact connection type	Socket

Interlock

Locking type	Screw locking mechanism
Mounting flange	Screw flange
Tightening torque	0.3 Nm

Conductor connection

Connection method	Screw connection with tension sleeve
Conductor/PCB connection direction	-90 °
Conductor cross section rigid	0.2 mm ² ... 2.5 mm ²
Conductor cross section flexible	0.2 mm ² ... 2.5 mm ²

GMVSTBW 2,5/11-STF-7,62 EX - PCB connector



1810094

<https://www.phoenixcontact.com/us/products/1810094>

Conductor cross section AWG	24 ... 12
Conductor cross section flexible, with ferrule without plastic sleeve	0.25 mm ² ... 2.5 mm ²
Conductor cross section, flexible, with ferrule, with plastic sleeve	0.25 mm ² ... 2.5 mm ²
2 conductors with same cross section, solid	0.2 mm ² ... 1 mm ²
2 conductors with same cross section, flexible	0.2 mm ² ... 1.5 mm ²
2 conductors with same cross section, flexible, with ferrule without plastic sleeve	0.25 mm ² ... 1 mm ²
2 conductors with the same cross section, flexible, with TWIN ferrule with plastic sleeve	0.5 mm ² ... 1 mm ²
Cylindrical gauge a x b / diameter	2.8 mm x 2.0 mm / 2.4 mm
Stripping length	7 mm
Tightening torque	0.5 Nm ... 0.6 Nm

Material specifications

Material data - contact

Note	WEEE/RoHS-compliant, free of whiskers according to IEC 60068-2-82/JEDEC JESD 201
Contact material	Cu alloy
Surface characteristics	hot-dip tin-plated
Metal surface terminal point (top layer)	Tin (4 - 8 µm Sn)
Metal surface contact area (top layer)	Tin (4 - 8 µm Sn)

Material data - housing

Color (Housing)	green (6021)
Insulating material	PA
Insulating material group	I
CTI according to IEC 60112	600
Flammability rating according to UL 94	V0
Glow wire flammability index GWFI according to EN 60695-2-12	850
Glow wire ignition temperature GWIT according to EN 60695-2-13	775
Temperature for the ball pressure test according to EN 60695-10-2	125 °C

Dimensions

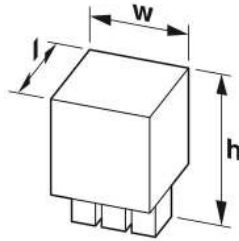
Dimensional drawing	
Pitch	7.62 mm
Width [w]	81.78 mm

GMVSTBW 2,5/11-STF-7,62 EX - PCB connector



1810094

<https://www.phoenixcontact.com/us/products/1810094>

Height [h]	26 mm
Length [l]	12.52 mm

Mounting

Drive form screw head	Slotted (L)
Connection method	Screw connection with tension sleeve
Drive form screw head	Slotted (L)

Flange

Tightening torque	0.3 Nm
-------------------	--------

Notes

Notes on operation	In accordance with IEC 61984, COMBICON connectors have no switching power (COC). During designated use, they must not be plugged in or disconnected when carrying voltage or under load.
--------------------	--

Environmental and real-life conditions

Ambient conditions

Ambient temperature (operation)	-60 °C ... 110 °C
Ambient temperature (storage/transport)	-40 °C ... 70 °C
Relative humidity (storage/transport)	30 % ... 70 %
Ambient temperature (assembly)	-5 °C ... 100 °C

Packaging specifications

Type of packaging	packed in cardboard
-------------------	---------------------

GMVSTBW 2,5/11-STF-7,62 EX - PCB connector



1810094

<https://www.phoenixcontact.com/us/products/1810094>

Drawings

Dimensional drawing

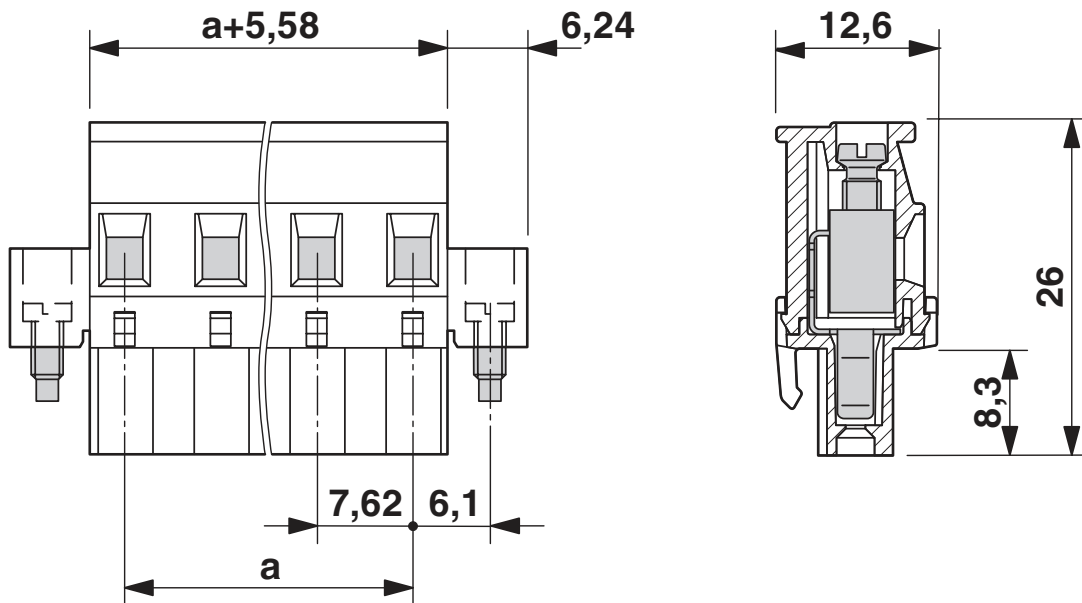

GMVSTBW 2,5/11-STF-7,62 EX - PCB connector





1810094

<https://www.phoenixcontact.com/us/products/1810094>

Approvals

To download certificates, visit the product detail page: <https://www.phoenixcontact.com/us/products/1810094>

 ATEX Approval ID: KEMA 10ATEX0196 U				
	Nominal voltage U_N	Nominal current I_N	Cross section AWG	Cross section mm^2
	352 V	12 A	-	0.2 - 2.5

 IECEX Approval ID: IECEX KEM 10.0093U				
	Nominal voltage U_N	Nominal current I_N	Cross section AWG	Cross section mm^2
	352 V	12 A	-	0.2 - 2.5

 EAC Ex Approval ID: B.00065/19				
---	--	--	--	--

 CCC Approval ID: 2021122313114375				
---	--	--	--	--

GMVSTBW 2,5/11-STF-7,62 EX - PCB connector



1810094

<https://www.phoenixcontact.com/us/products/1810094>

Classifications

ECLASS

ECLASS-11.0	27460202
ECLASS-12.0	27460202
ECLASS-13.0	27460202

ETIM

ETIM 8.0	EC002638
----------	----------

UNSPSC

UNSPSC 21.0	39121400
-------------	----------

GMVSTBW 2,5/11-STF-7,62 EX - PCB connector



1810094

<https://www.phoenixcontact.com/us/products/1810094>

Environmental product compliance

China RoHS	Environmentally friendly use period: unlimited = EFUP-e
	No hazardous substances above threshold values

GMVSTBW 2,5/11-STF-7,62 EX - PCB connector



1810094

<https://www.phoenixcontact.com/us/products/1810094>

Accessories

CP-MSTB - Coding profile

1734634

<https://www.phoenixcontact.com/us/products/1734634>

Coding profile, is inserted into the slot on the plug or inverted header, red insulating material



MPS-MT - Test plugs

0201744

<https://www.phoenixcontact.com/us/products/0201744>

Test plugs, with solder connection up to 1 mm² conductor cross section, number of positions: 1, color: gray



GMVSTBW 2,5/11-STF-7,62 EX - PCB connector

1810094

<https://www.phoenixcontact.com/us/products/1810094>



RPS - Reducing plug

0201647

<https://www.phoenixcontact.com/us/products/0201647>



Reducing plug, number of positions: 1, color: gray

SZS 0,6X3,5 - Screwdriver

1205053

<https://www.phoenixcontact.com/us/products/1205053>



Actuation tool, for ST terminal blocks, insulated, also suitable for use as a bladed screwdriver, size: 0.6 x 3.5 x 100 mm, 2-component grip, with non-slip grip

GMVSTBW 2,5/11-STF-7,62 EX - PCB connector



1810094

<https://www.phoenixcontact.com/us/products/1810094>

SK 5,08/3,8:FORTL.ZAHLEN - Marker card

0804293

<https://www.phoenixcontact.com/us/products/0804293>



Marker card, white, labeled, horizontal: consecutive numbers 1 ... 10, 11 ... 20, etc. up to 91 ... (99)100, mounting type: adhesive, for terminal block width: 5.08 mm, lettering field size: 5.08 x 3.8 mm

SK 5,08/3,8:UNBEDRUCKT - Marker card

0805412

<https://www.phoenixcontact.com/us/products/0805412>



Marker card, Din A4, white, unlabeled, can be labeled with: Marker pen: without print, mounting type: adhesive, for terminal block width: 5.08 mm, lettering field size: 5.08 x 3.8 mm, Number of individual labels: 1

GMVSTBW 2,5/11-STF-7,62 EX - PCB connector

1810094

<https://www.phoenixcontact.com/us/products/1810094>



B-STIFT - Marker pen

1051993

<https://www.phoenixcontact.com/us/products/1051993>



Marker pen, for manual labeling of unprinted Zack strips, smear-proof and waterproof, line thickness 0.5 mm

GMSTB 2,5/11-GF-7,62 EX - PCB header

1795970

<https://www.phoenixcontact.com/us/products/1795970>



PCB headers, nominal cross section: 2.5 mm², color: green, nominal current: 12 A, contact surface: Tin, contact connection type: Pin, number of potentials: 11, number of rows: 1, number of positions: 11, number of connections: 11, product range: GMSTB 2,5/..-GF-EX, pitch: 7.62 mm, mounting: Wave soldering, pin layout: Linear pinning, solder pin [P]: 3.2 mm, number of solder pins per potential: 1, plug-in system: COMBICON MSTB 2,5 EX, Pin connector pattern alignment: Standard, locking: Screw locking mechanism, mounting: Threaded flange, type of packaging: packed in cardboard

GMVSTBW 2,5/11-STF-7,62 EX - PCB connector



1810094

<https://www.phoenixcontact.com/us/products/1810094>

GMSTBV 2,5/11-GF-7,62 EX - PCB header

1796759

<https://www.phoenixcontact.com/us/products/1796759>



PCB headers, nominal cross section: 2.5 mm², color: green, nominal current: 12 A, contact surface: Tin, contact connection type: Pin, number of potentials: 11, number of rows: 1, number of positions: 11, number of connections: 11, product range: GMSTBV 2,5/..-GF-EX, pitch: 7.62 mm, mounting: Wave soldering, pin layout: Linear pinning, solder pin [P]: 3.9 mm, number of solder pins per potential: 1, plug-in system: COMBICON MSTB 2,5, Pin connector pattern alignment: Standard, locking: Screw locking mechanism, mounting: Threaded flange, type of packaging: packed in cardboard

Phoenix Contact 2023 © - all rights reserved

<https://www.phoenixcontact.com>

Phoenix Contact USA
586 Fulling Mill Road
Middletown, PA 17057, United States
(+717) 944-1300
info@phoenixcon.com