

## ONBOARD-89

### Features

- High Performance SMD Antenna
- 860-870/902-928MHz
- Total Efficiency > 66%  
(-1.8dB)
- Return Loss <-10dB: <-6dB
- Impedance 50 ohm
- Measures 34 x 12 x 5mm
- Supplied Tape and Reel
- -40 to +85°C



### Applications

- General Purpose Lower Power Radio
- Space Saving Applications
- M2M Industrial

### Description

A Proant ONBOARD miniature Antenna for general ISM Band applications provides a high performance surface mounting Component Antenna.

Integrated antenna are a trade off of different aspects of RF design. This antenna provides a significantly higher performance over many embedded antennas whilst having a marginally larger footprint.

### Ordering Information

Part No	Description
ONBOARD-89	Mini antenna GPS
ONBOARD-89EVAL	Evaluation Board

## General Design Considerations

### 1. General

This document is a guideline for implementation of the OnBoard SMD 868/915 antenna. The antenna is a combination of small size, low cost and high performance. Integration of embedded antennas is a task that involves tradeoff of different aspects, and this document aims to help when optimizing the performance of the antenna solution.

### 2. Intended applications

The antenna is optimized for the 860 – 870 MHz and 902 - 928 MHz license free bands. This application note covers 860 - 870 MHz operation. The frequency optimization to each band is performed by tuning components.

ZigBee	IEEE 802.15.4	868.0-868.6 MHz
Z-Wave		868 MHz
EnOcean	ISO/IEC 14543-3-10	868 MHz
Sigfox		868 MHz
Wireless M-Bus	EN 13757-4:2013 mode S	868.0-868.6 MHz
	EN 13757-4:2013 mode T	868.0-869.2 MHz
	EN 13757-4:2013 mode R2	868.0-868.6 MHz
	EN 13757-4:2013 mode C	868.7-869.65 MHz

Frequency <sup>1</sup>	860 - 870 MHz
Impedance <sup>1</sup>	50 Ω
Return loss <sup>1</sup>	<-10 dB
Total efficiency <sup>1</sup>	> 65% (-1.8dB)
Dimensions (LxBxH)	34 x 11.6 x 5.0 mm (1.34 x 0.46 x 0.20 in)
Assembly	Pick and place
Soldering	Reflow or equivalent
Packing	Tape and reel
Temperature	-40 to +125° C
Mechanical resistance <sup>2</sup>	Immunity to vibrations IEC/EN 60068-2-6, Fc test Immunity to shock IEC/EN 60068-2-27, Ea test

1) Measured on the evaluation board 860 - 870 MHz, ONBOARD-89EVAL

2) The product has been tested according to the standard IEC 60721-3-5 – Class 5M3 (road vehicles in areas without well-developed road systems, light-weighted vehicles, tracked vehicles and self propelled machines)

## Antenna Footprint

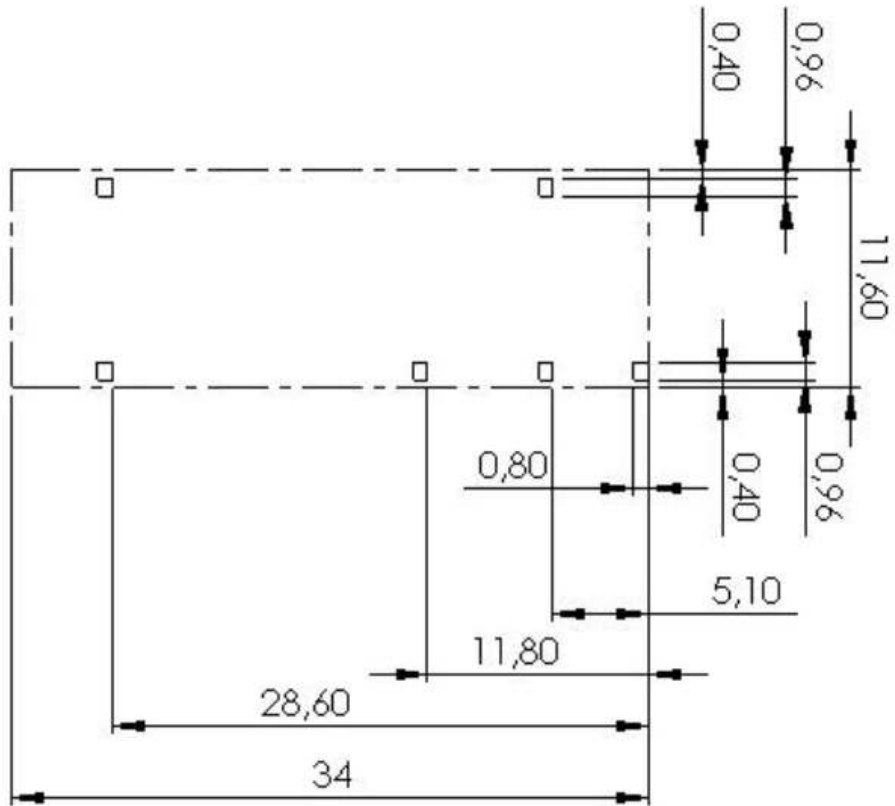

The sketch shows the antenna footprint and keep-out block. Above dimensions are mm.

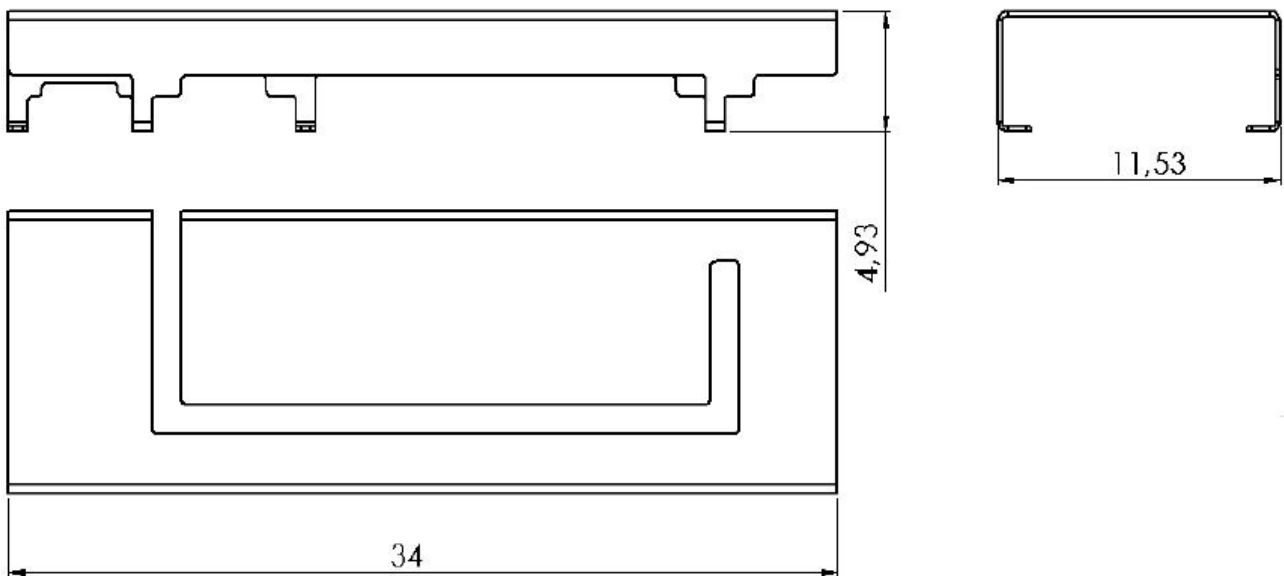

## PCB Layout

This antenna is designed for optimum performance when PCB mounted on a ground plane. All empty space in the layout should be flooded with Copper. No ground cutout area is required under the antenna. If there are several layers in the pcb, there is an advantage to add via holes for interconnection of the ground areas. It is also very important that there is a ground clearance around the NC pads, through all layers of the pcb. Otherwise there will be capacitive coupling which may detune the antenna.

## PCB Layout (as implemented on Evaluation Board)

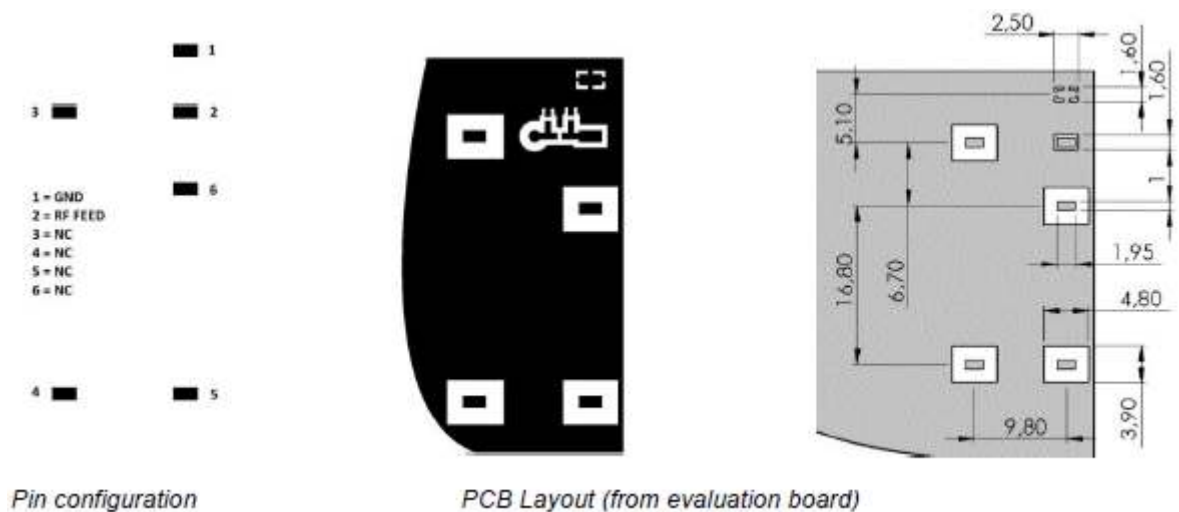

Pin configuration

PCB Layout (from evaluation board)

The antenna is preferably positioned along one side of the PCB ground plane, where pin 1 shall be as close as possible to the layout corner.

It is also recommended to implement a pi-matching network as seen in the PCB layout to compensate for eventual mismatch due to the practical implementation. The components can be positioned below the antenna next to the feed pad. See chapter 8 for more details.

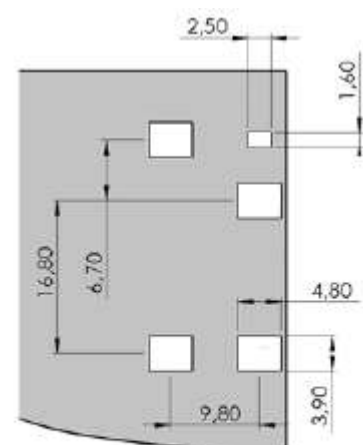

Clearance through all layers

## 6. Electrical performance

All results are measured with the antenna mounted on the evaluation board.

### Smith chart

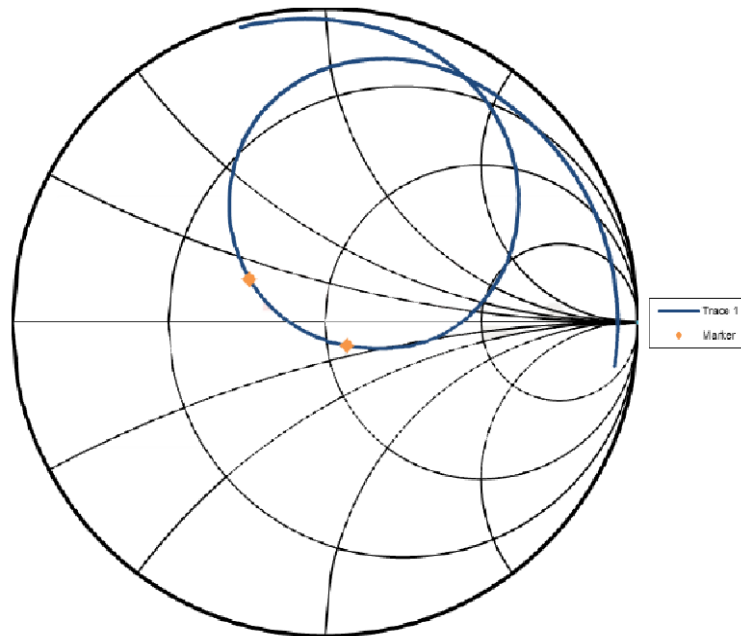

### Return Loss

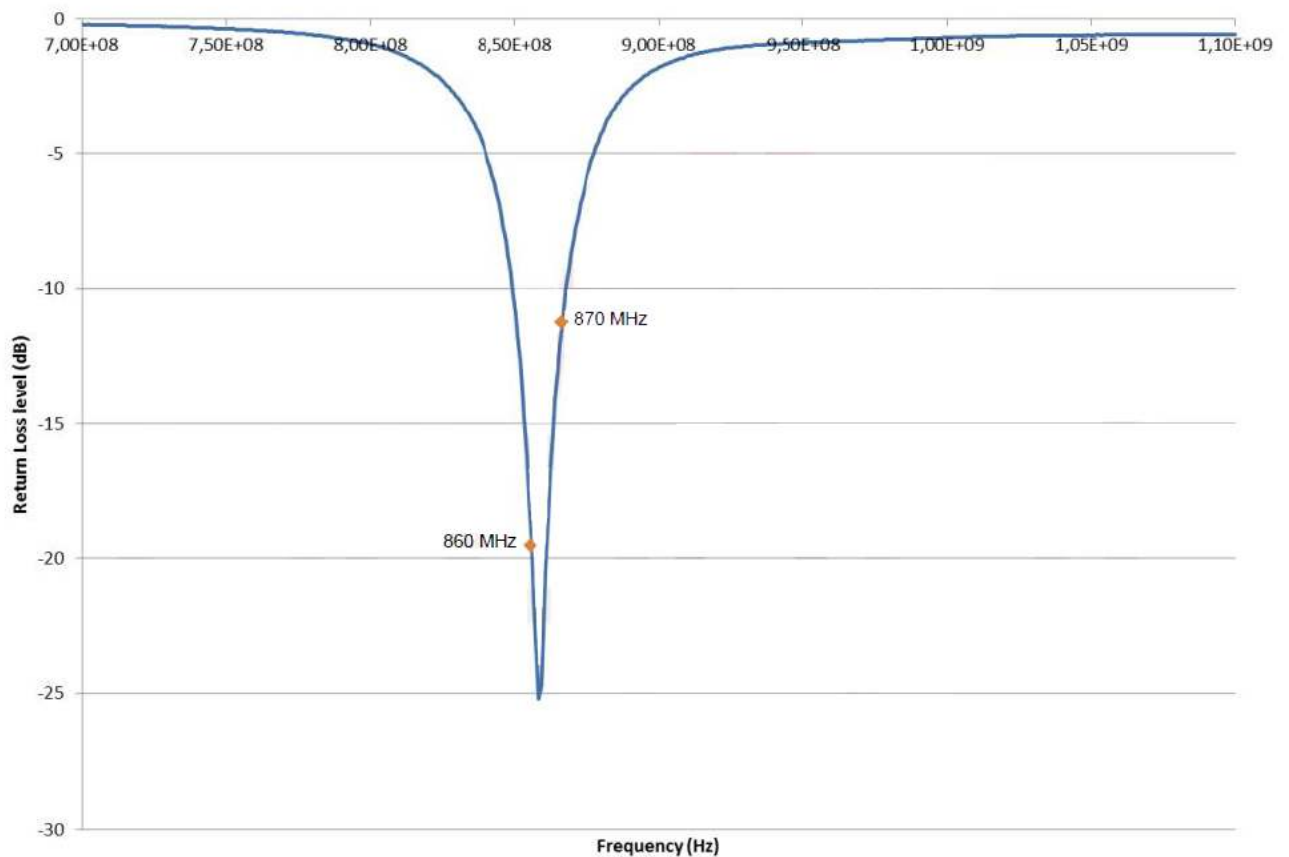

## Total efficiency

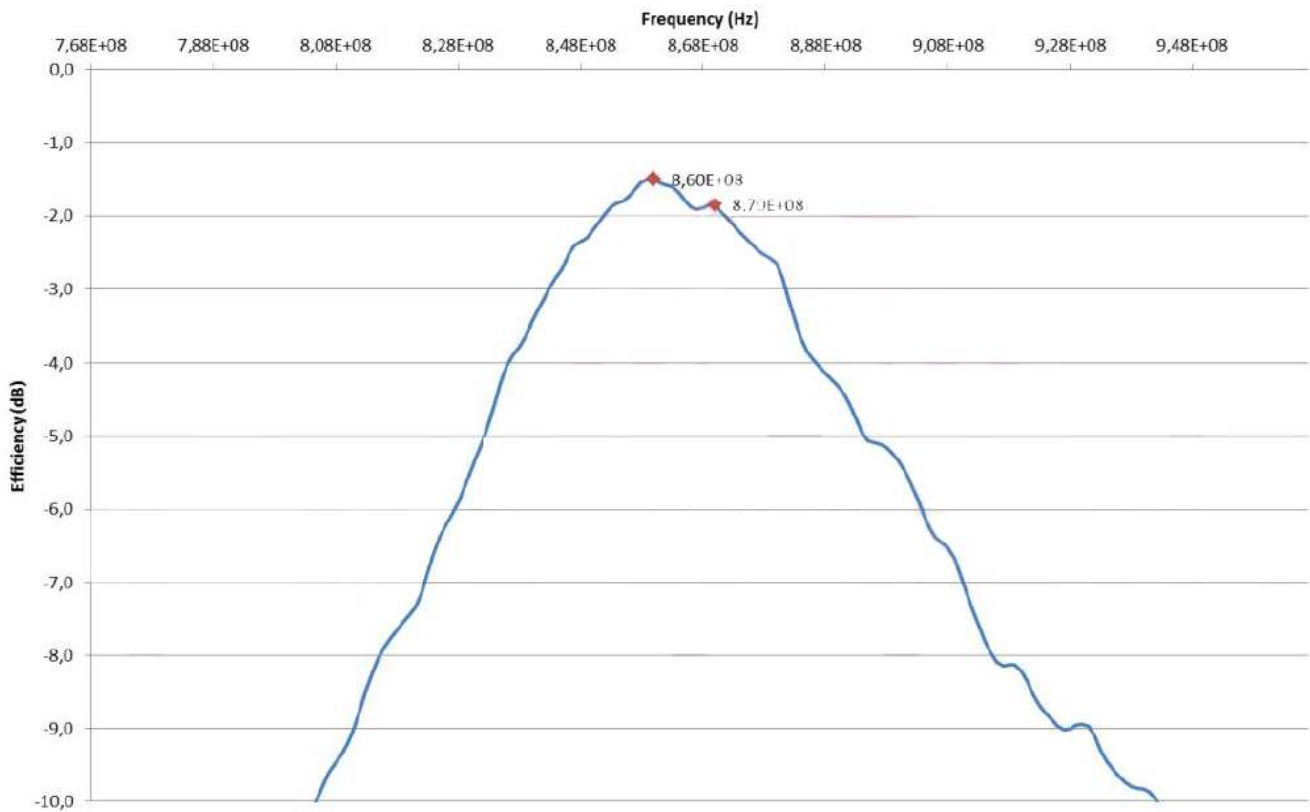

## Maximum gain

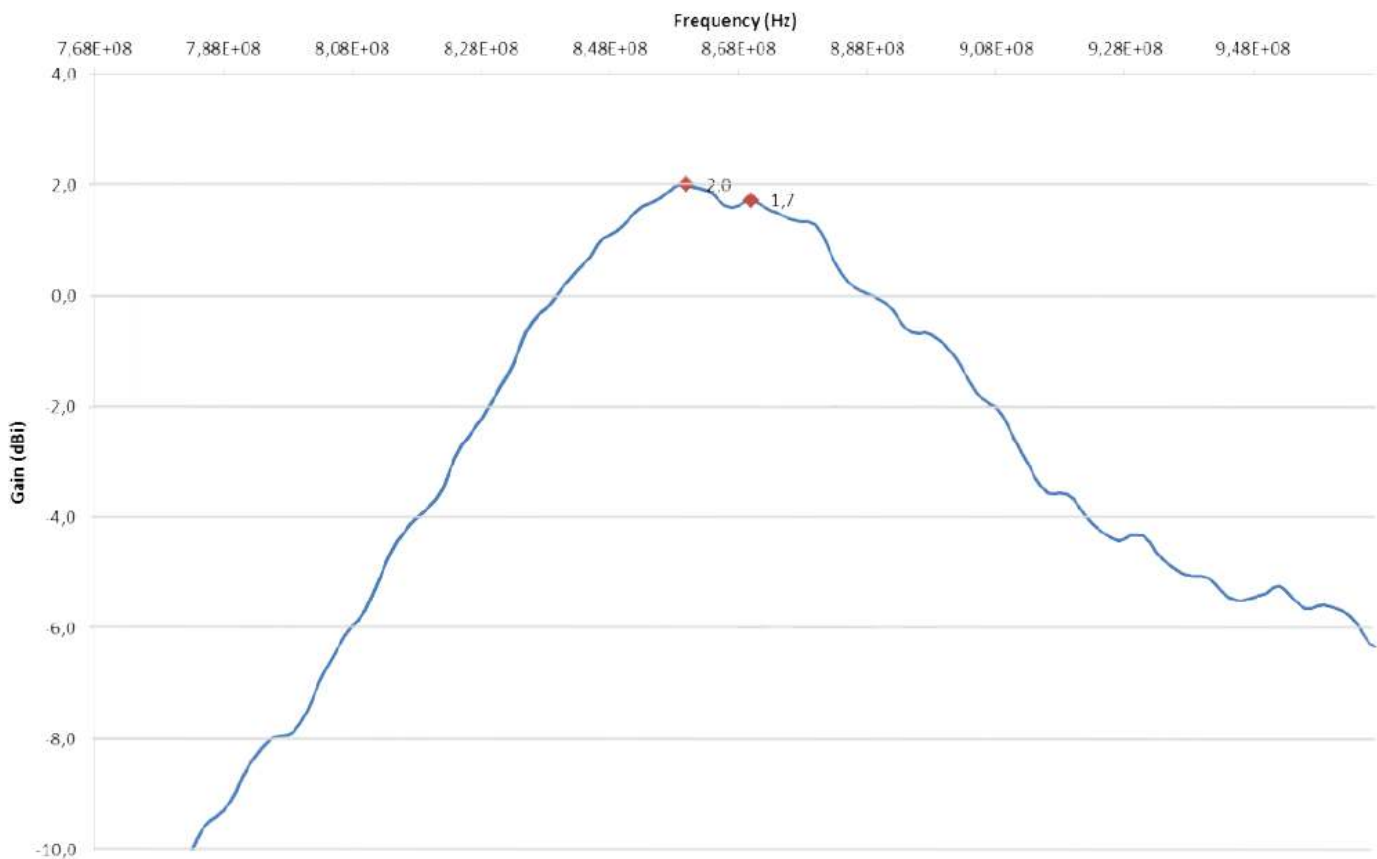

## Radiation pattern

All results are measured at 868 MHz with antenna mounted on the evaluation board. The figure to the right shows the corresponding antenna position for each chart. Gain values are given in dBi.

VP = Vertical Polarization, HP = Horizontal Polarization

### H plane

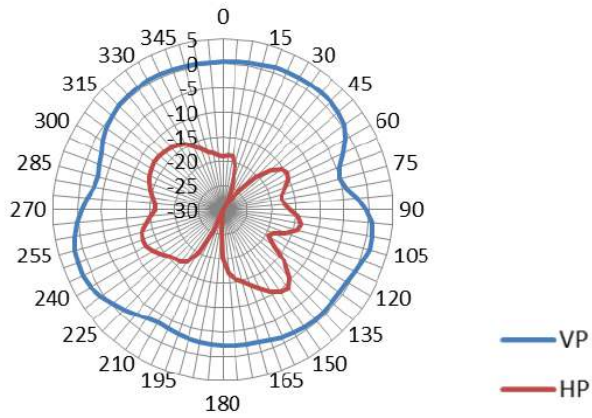

### V0 plane

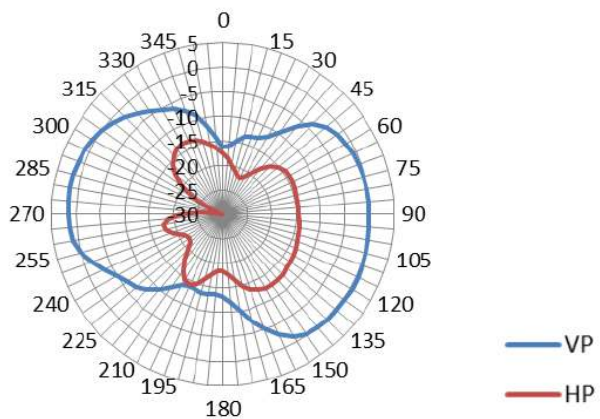

### V90 plane

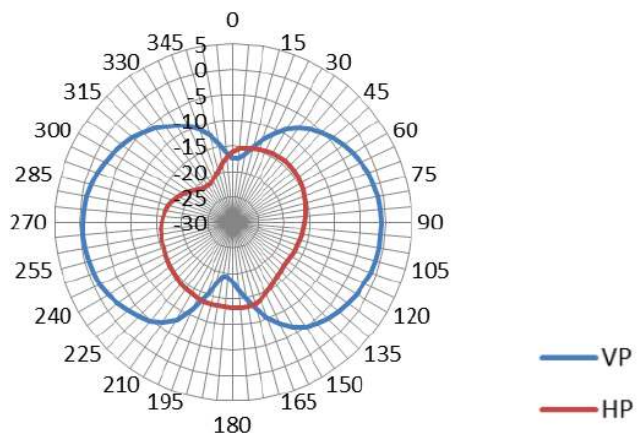

## OnBoard SMD 868 Evaluation board

The evaluation board is developed to simplify antenna testing and evaluation. It has an arbitrary size of 120 x 50 mm and includes an SMA connector. The purpose is to give a reference design for an optimal antenna implementation. The evaluation board can also be used to test other implementations by cutting and soldering the PCB into any device.

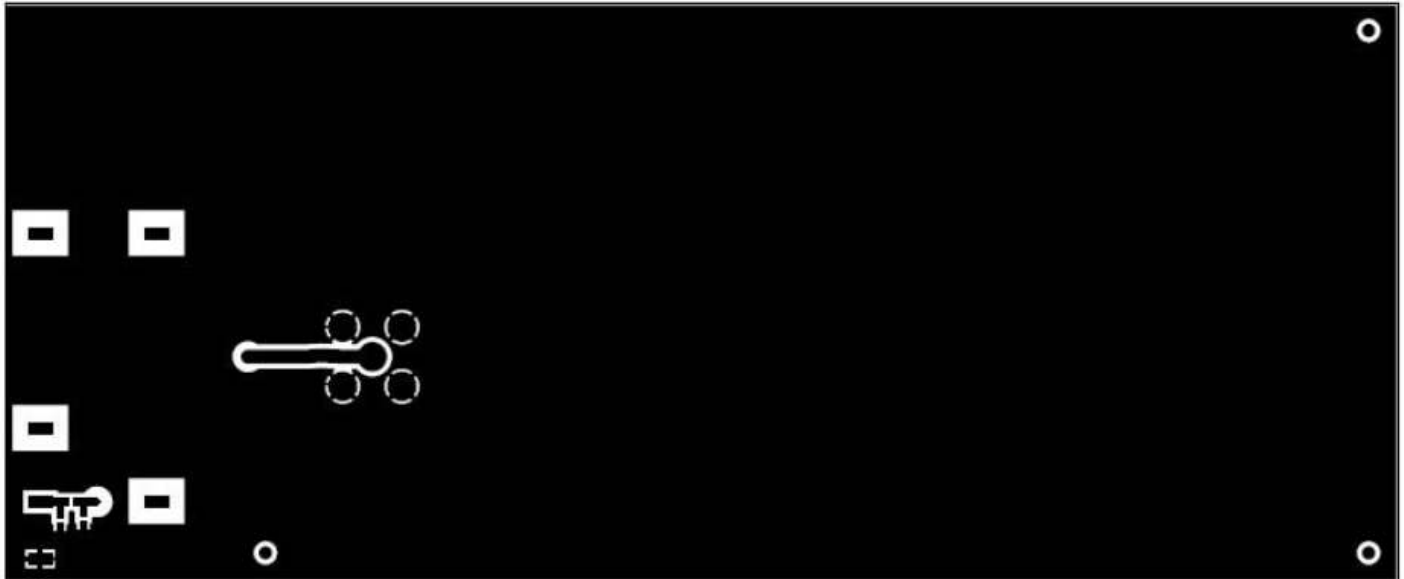

### Evaluation board outline

The evaluation board has a matching circuit implemented next to the antenna. This is aimed to enable optimization possibilities for the user. The component positions are sized for 0402 (1005 metric) SMD components.

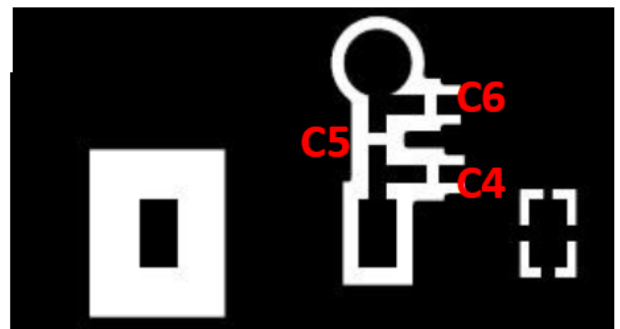
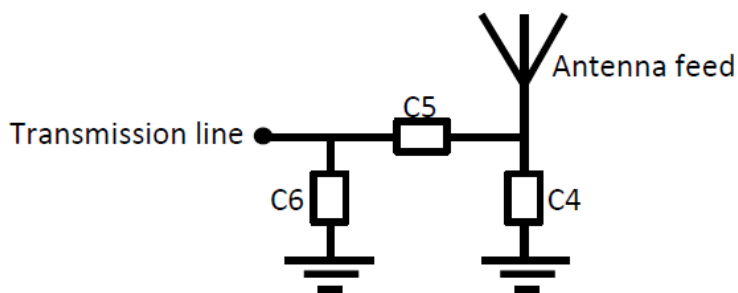

### Matching circuit

The antenna needs a matching circuit to adjust the resonant frequency balance. When delivered, the evaluation board is tuned for optimum balance at the 860-870 MHz frequency band. The component values for this setup are:

C4 = N/A C5 = 5.6 pF (Murata GRM1555C1H5R6DZ01) C6 = 2.2 pF (Murata GRM1555C1H2R2CZ01).

However, it is common that the resonant frequency will shift during implementation in an arbitrary device. Therefore this matching may be changed for compensation of such effects. This is further described in chapter 9.



## Design Considerations

The antenna can be positioned in different ways, although there are some positions which are more beneficial. Below picture shows a typical pcb with two possible antenna positions. We have arranged the positions according to the general best fit.

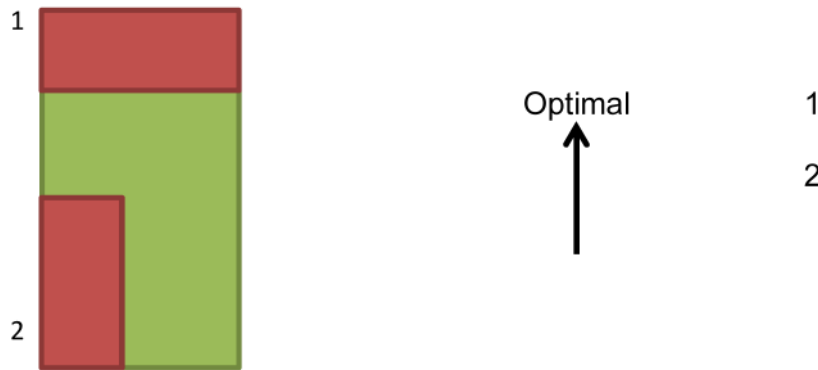

The antenna should be aligned with the pcb edge if possible. It is also important to align pin 1, 2, 3 and 4 along the outer side of the pcb, and ideally close to a corner.

The antenna enables that small electrical components are mounted inside the antenna keep-out block. This is a space-efficient solution which has very little influence on the performance. It may have an impact on the antenna tuning, but is possible if there is limited space on the pcb. Another general aspect on surface mounted antennas is regarding the pcb population. If other electrical components are positioned in the surrounding area of the antenna, some impact on the antenna tuning and radiated performance may be expected. It is recommended that such components are distributed below a topographical slope that starts on pcb level at the antenna keep-out block, and slowly increases the height.

It shall also be highlighted that plastic and metal parts in the near proximity of antennas may influence the antenna tuning and/or impedance. This aspect should be noted as a general guideline for all antennas. The effects are difficult to estimate without detailed information, but it is common that a plastic housing above the antenna shifts the frequency tuning lower. It is recommended to measure the antenna in the actual device after implementation.

## Tape and Reel Packaging Data

The antenna is delivered on tape and reel according to following specifications. The quantity per 13" reel is 250 pcs.

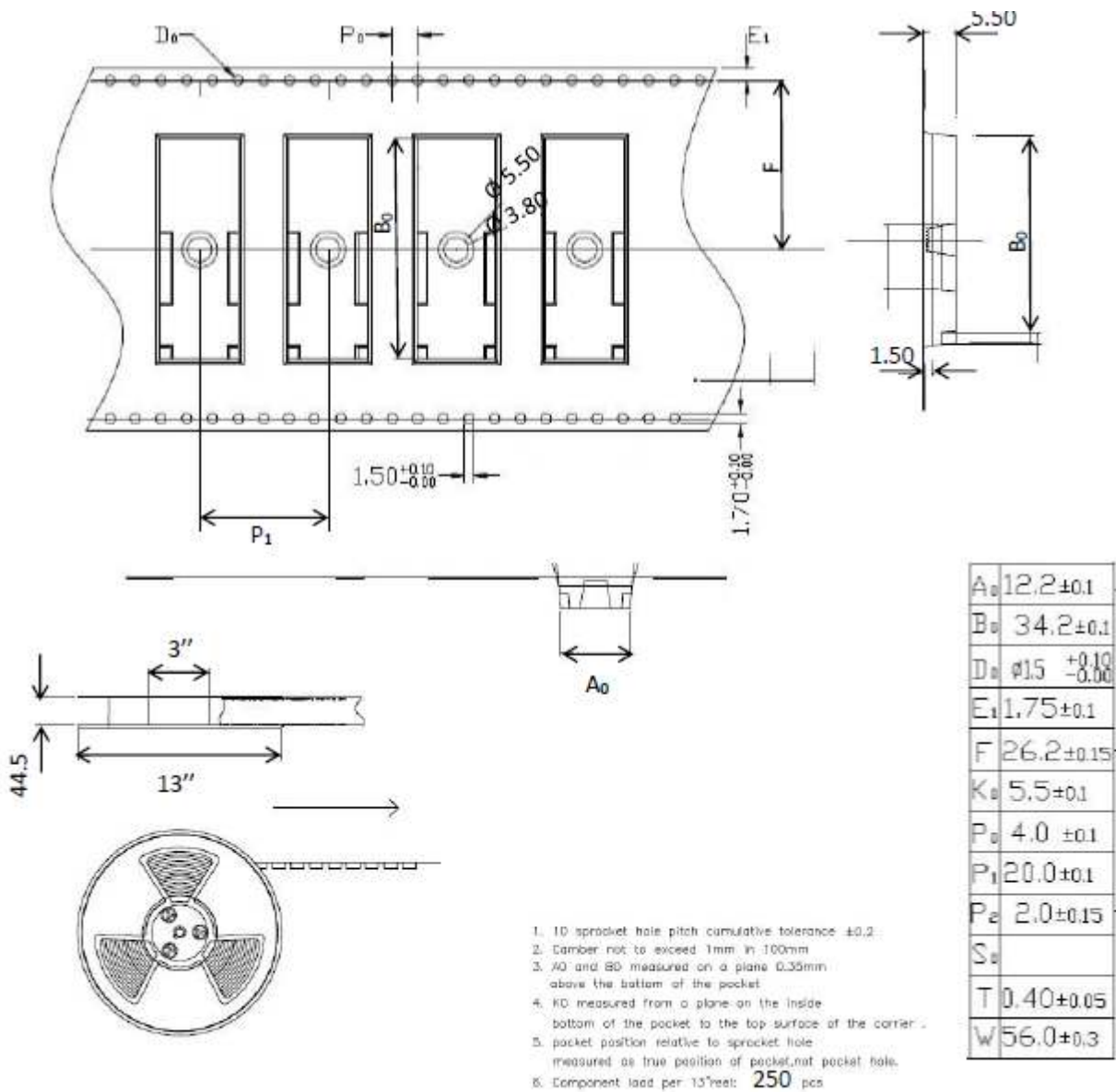

## Part marking

The top marking of the antenna is arranged according to the following illustration.

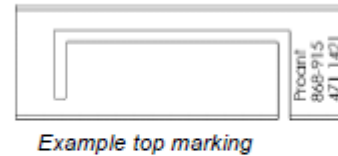
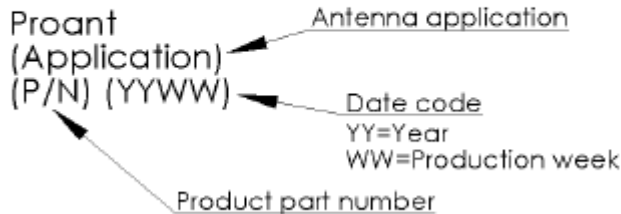

### RF Solutions Ltd. Recycling Notice

Meets the following EC Directives:

#### DO NOT

Discard with normal waste, please recycle.

#### ROHS Directive 2011/65/EU and amendment 2015/863/EU

Specifies certain limits for hazardous substances.

#### WEEE Directive 2012/19/EU

Waste electrical & electronic equipment. This product must be disposed of through a licensed WEEE collection point. RF Solutions Ltd., fulfills its WEEE obligations by membership of an approved compliance scheme.

Environment Agency producer registration number: **WEE/JB0104WV**.

### Waste Batteries and Accumulators Directive 2006/66/EC

Where batteries are fitted, before recycling the product, the batteries must be removed and disposed of at a licensed collection point.

#### Disclaimer:

Whilst the information in this document is believed to be correct at the time of issue, RF Solutions Ltd does not accept any liability whatsoever for its accuracy, adequacy or completeness. No express or implied warranty or representation is given relating to the information contained in this document. RF Solutions Ltd reserves the right to make changes and improvements to the product(s) described herein without notice. Buyers and other users should determine for themselves the suitability of any such information or products for their own particular requirements or specification(s). RF Solutions Ltd shall not be liable for any loss or damage caused as a result of user's own determination of how to deploy or use RF Solutions Ltd's products. Use of RF Solutions Ltd products or components in life support and/or safety applications is not authorised except with express written approval. No licences are created, implicitly or otherwise, under any of RF Solutions Ltd's intellectual property rights. Liability for loss or damage resulting or caused by reliance on the information contained herein or from the use of the product (including liability resulting from negligence or where RF Solutions Ltd was aware of the possibility of such loss or damage arising) is excluded. This will not operate to limit or restrict RF Solutions Ltd's liability for death or personal injury resulting from its negligence.