









- enclosure:
-  2x fixing bolt
 -  1x sealing ring
 -  1x blind grommet
 -  3x blind grommet
 -  3x blind grommet
 -  2x tapping screw

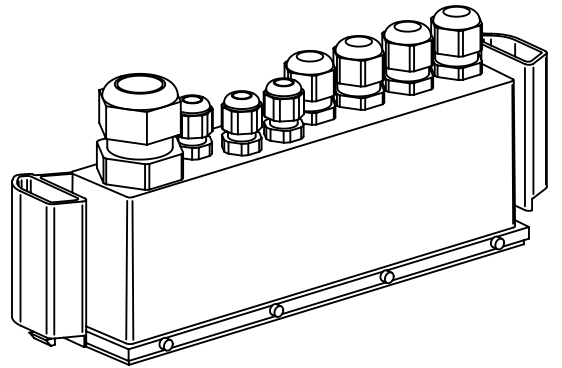

	All Dimensions in mm Original Size DIN A4		Scale 1:2	Free size tol.		Ref. Sub. 20 93 901 0101 v. 08.07.11	
	All rights reserved Department EL PD - DE		Created by WULF	Inspected by STICKFORTH	Standardisation TIEMANNA	Date 2015-07-13	State Final Release
HARTING Electric GmbH & Co. KG D-32339 Espelkamp			Title Protect Cover RF-R500			Doc-Key / ECM-Nr. 100214613/UGD/002/B 500000091576	
			Type TB	Number 20 93 901 0101		Rev. B	Page 1/1