

## EQD075 Series (Eighth-Brick)DC-DC Converter Power Modules

**18- 60Vdc Input; 3.3 to 5.0Vdc Output; 75W**

### RoHS Compliant



### Applications

- Distributed power architectures
- Wireless Networks
- Optical and Access Network Equipment
- Enterprise Networks

### Options

- Positive logic, Remote On/Off
- Auto restart after fault protection shutdown
- Pin length

### Description

The EQD075 series DC-DC converters are a new generation of open-frame DC/DC power modules designed to support a 3:1 input voltage range, that allows operation in both 24V or 48V nominal input voltage systems, thus eliminating the need for separate power modules for each input voltage range. These single output DC-DC converters operate over an input voltage range of 18 to 60 Vdc. The series is also designed to provide a wide output voltage set/trim range of 3.0 to 5.5Vdc, with output current up to 20A at 3.3Vdc or 15A at 5.0Vdc in an industry standard eighth brick package. The output is isolated from the input, allowing versatile polarity configurations and grounding connections. Built in filtering for both input and output minimizes the need for external filtering.

### Features

- Compliant to RoHS EU Directive 2002/95/EC (-Z versions)
- Compliant to RoHS EU Directive 2002/95/EC with lead solder exemption (non-Z versions)
- High efficiency – 92% at 5.0V<sub>o</sub>, full load, 24V<sub>in</sub>
- Industry standard Eighth brick footprint and pin out  
57.9 mm x 22.8 mm x 8.5 mm  
(2.28 in. x 0.90 in. x 0.335 in.)
- 3:1 Input voltage range: 18 - 60 Vdc
- Input under/overvoltage protection
- Output overcurrent/voltage protection
- Over-temperature protection
- Tightly regulated output
- Remote sense
- No reverse current during output shutdown
- Negative logic, Remote On/Off
- Output voltage programmable from 3.0 Vdc to 5.5Vdc
- Input-to-output isolation (Basic Insulation: 1500V)
- Wide operating temperature range (-40°C to 85°C)
- Meets conducted emissions requirements of FCC/EN55022 Class A without external filter  
Within FCC and VDE Class A Radiated Limits
- *UL*\* 60950-1 Recognized, *CSA*† C22.2 No. 60950-1-03 Certified, and *VDE*‡ 0805:2001-12 (EN60950-1) Licensed
- Meets the voltage and current requirements for ETSI 300-132-2 and complies with and licensed for Basic insulation rating per EN60950-1
- ISO\*\* 9001 and ISO 14001 certified manufacturing facilities

\* *UL* is a registered trademark of Underwriters Laboratories, Inc.

† *CSA* is a registered trademark of Canadian Standards Association.

‡ *VDE* is a trademark of Verband Deutscher Elektrotechniker e.V.

\*\* ISO is a registered trademark of the International Organization of Standards

## Absolute Maximum Ratings

Stresses in excess of the absolute maximum ratings can cause permanent damage to the device. These are absolute stress ratings only, functional operation of the device is not implied at these or any other conditions in excess of those given in the operations sections of the data sheet. Exposure to absolute maximum ratings for extended periods can adversely affect the device reliability.

Parameter	Device	Symbol	Min	Max	Unit
Input Voltage					
Continuous	A	$V_{IN}$	-0.3	60	Vdc
Transient (100 ms)		$V_{IN, trans}$	-0.3	75	Vdc
Operating Ambient Temperature (see Thermal Considerations section)	A	$T_A$	-40	85	°C
Storage Temperature	A	$T_{stg}$	-55	125	°C
I/O Isolation (100% factory Hi-Pot tested)					
Input - Output	A			1500	Vdc

## Electrical Specifications

Unless otherwise indicated, specifications apply over all operating input voltage, resistive load, and temperature conditions.

Parameter	Device	Symbol	Min	Typ	Max	Unit
Operating Input Voltage	A	$V_{IN}$	18	24/48	60	Vdc
Maximum Input Current ( $V_{IN}=0$ to $V_{IN, max}$ , $V_o = V_{o, set}$ , $I_o = I_{o, max}$ )	A	$I_{IN, max}$			6	Adc
Input Stand-by Current Module on / off disabled ( $V_{IN} = V_{IN, nom}$ , $V_o = 0$ V)	A	$I_{IN, Stby}$			25	mA
Input No Load Current Module on / off enabled ( $V_{IN} = V_{IN, nom}$ , $I_o = 0$ A)	A	$I_{IN, NL}$			110	mA
Inrush Transient	A	$i^2t$			1	A <sup>2</sup> s
Input Reflected Ripple Current, peak-to-peak (5Hz to 20MHz, 12μH source impedance; $T_a$ 25°C, $C_{in} = 33\mu F$ )	A				30	mAp-p
Input Ripple Rejection (100 - 120Hz)	A		50			dB

**CAUTION: This power module is not internally fused. An input line fuse must always be used.**

This power module can be used in a wide variety of applications, ranging from simple standalone operation to being part of a complex power architecture. To preserve maximum flexibility, internal fusing is not included, however, to achieve maximum safety and system protection, always use an input line fuse. The safety agencies require a very fast acting surface mount fuse with a maximum rating of 6.3 A (see Safety Considerations section). Based on the information provided in this data sheet on inrush energy and maximum dc input current, the same type of fuse with a lower rating can be used. Refer to the fuse manufacturer's data sheet for further information.

Electrical Specifications (continued)

Parameter	Device	Symbol	Min	Typ	Max	Unit
Output Voltage Set-point ( $V_{IN} = V_{IN, min} = 24/48, I_O = I_{O, max}, T_A = 25^\circ C$ )	A	$V_{O, set}$	-1.6		+1.6	% $V_{O, set}$
Output Voltage (Over all line, load, and Temp Conditions Until end of life)	A	$V_O$	-3	-	+3	% $V_O$
Output Regulation Line ( $V_{IN} = V_{IN, min}$ to $V_{IN, max}$ )	A		—	0.05	0.2	% $V_{O, nom}$
Load ( $I_O = I_{O, min}$ to $I_{O, max}$ )	A		—	0.05	0.2	% $V_{O, nom}$
Temperature ( $T_{ref} = T_{A, min}$ to $T_{A, max}$ )	A		—	0.25	1	% $V_{O, nom}$
Output Ripple and Noise on nominal output ( $V_{IN} = V_{IN, nom}$ and $I_O = I_{O, min}$ to $I_{O, max}$ , $C_{out} = 1\mu F$ ceramic // $10\mu F$ Tantalum capacitor) 3.3 to 5.0V output						
RMS (5Hz to 20MHz bandwidth)	A		—	5	20	mV <sub>rms</sub>
Peak-to-Peak (5Hz to 20MHz bandwidth)	A		—	50	80	mV <sub>pk-pk</sub>
External Capacitance ESR $\geq 10$ m $\Omega$	A	$C_O$	0	—	5000	$\mu F$
Output Current @ $V_O = 3.3V$	A	$I_O$	0		20	A dc
@ $V_O = 5V$	A	$I_O$	0		15	A dc
Output Current Limit Inception (Hiccup Mode) ( $V_O = 95\% V_{O, set}$ )	A	$I_{O, lim}$	105	115	150	% $I_{O, max}$
Output Short-Circuit Current $V_O \leq 250$ mV @ $25^\circ C$	A	$I_{O, s/c}$	—	—	150	% $I_{O, max}$
Efficiency $V_{IN} = 24V, T_A = 25^\circ C, I_O = I_{O, max} A$ @ $V_O = 3.3V, I_O = 20A$	A	$\eta$		87		%
@ $V_O = 5V, I_O = 15A$	A	$\eta$		92		%
$V_{IN} = 48V, T_A = 25^\circ C, I_O = I_{O, max} A$ @ $V_O = 3.3V, I_O = 20A$	A	$\eta$		88		%
@ $V_O = 5V, I_O = 15A$	A	$\eta$		90		%
Switching Frequency	A	$f_{sw}$	160	—	—	KHz

### Electrical Specifications (continued)

Parameter	Device	Symbol	Min	Typ	Max	Unit
Dynamic Load Response ( $di_o/dt = 1A / 10\mu s$ ; $V_{IN} = V_{IN, nom}$ ; $T_A = 25^\circ C$ )						
Load Change from $I_o = 50\%$ to $75\%$ of $I_{o, max}$						
Peak Deviation	A	$V_{pk}$	—	2	4	$\%V_o$
Settling Time ( $V_o < 10\%$ peak deviation)		$t_s$	—	80	150	$\mu s$
Load Change from $I_o = 50\%$ to $25\%$ of $I_{o, max}$						
Peak Deviation	A	$V_{pk}$	—	2	4	$\%V_o$
Settling Time ( $V_o < 10\%$ peak deviation)		$t_s$	—	80	150	$\mu s$

### Isolation Specifications

Parameter	Min	Typ	Max	Unit
Isolation Capacitance	—	1000	—	pF
Isolation Resistance	10	—	—	$M\Omega$

### General Specifications

Parameter	Min	Typ	Max	Unit
Calculated MTBF ( $V_{IN} = 24V$ , $I_o = 80\%I_{o, max}$ , $T_A = 40^\circ C$ )		1,677,152		Hours
Weight	—	25.3 (0.89)	—	g (oz.)

## Feature Specifications

Unless otherwise indicated, specifications apply over all operating input voltage, resistive load, and temperature conditions. See Feature Descriptions for additional information.

Parameter	Device	Symbol	Min	Typ	Max	Unit
On/Off Signal interface ( $V_{IN}=V_{IN, min}$ to $V_{IN, max}$ ; Open collector or equivalent, Signal referenced to $V_{IN}(-)$ terminal)						
Logic Low (Module OFF)						
Input low Voltage = 0.0 V	A	$V_{IL}$	-0.7	—	1.2	V
Input low Current = 1 mA	A	$I_{IL}$	—	—	1.0	mA
Logic High (Module ON)						
Input High Voltage = 5.0 V	A	$V_{IH}$	—	—	5	V
Input High Current = 0 mA	A	$I_{IH}$	—	—	50	$\mu$ A
Turn-On Delay and Rise Times ( $I_O=80\% I_{O, max}$ , $T_A = 25^\circ\text{C}$ )						
Case 1: On/Off input is set to Logic High and then input power is applied (delay from instant at which $V_{IN} = V_{IN, min}$ until $V_o=10\%$ of $V_{o, nom}$ )	A	$T_{delay}$	—	15	20	msec
Case 2: Input power is applied for at least one second and then the On/Off input is set to logic high (delay from instant at which $V_{on}/V_{off} = 0.9V$ until $V_o=10\%$ of $V_{o, set}$ )	A	$T_{delay}$	—	5	10	msec
Output voltage Rise time (time for $V_o$ to rise from 10% of $V_{o, nom}$ to 90% of $V_{o, nom}$ ) $V_{o, nom}$ set to 3.3V	A	$T_{rise}$	—	10	15	msec
Output voltage Rise time (time for $V_o$ to rise from 10% of $V_{o, nom}$ to 90% of $V_{o, nom}$ ) $V_{o, nom}$ set to 5.0V	A	$T_{rise}$	—	15	20	msec
Output voltage overshoot – Startup $I_O = 80\%$ of $I_{O, max}$ ; $T_A = 25^\circ\text{C}$				—	1	% $V_{O, set}$
Input Undervoltage Lockout	A	$V_{UVLO}$				
Turn-on Threshold				17	18	V
Turn-off Threshold			14	15.5		V
Hysteresis				1.5		
Input Over voltage Lockout	A	$V_{OVLO}$				
Turn-on Threshold			60	62		V
Turn-off Threshold				64	65	V
Hysteresis				2		
Output Voltage Set point Adjustment						
Output remote sense voltage range (Max voltage drop is 0.5 V)	A	$V_{SENSE}$			10	% $V_{O, nom}$
Output voltage adjustment range (TRIM)	A		3.0		5.5	Vdc
Over voltage protection	A	$V_{OV, set}$	5.7		6.5	Vdc
Over Temperature Protection	A	$T_{ref}$		130		$^\circ\text{C}$

### Characteristic Curves

The following figures provide typical characteristics for EQD075A at  $T_A = 25^\circ\text{C}$

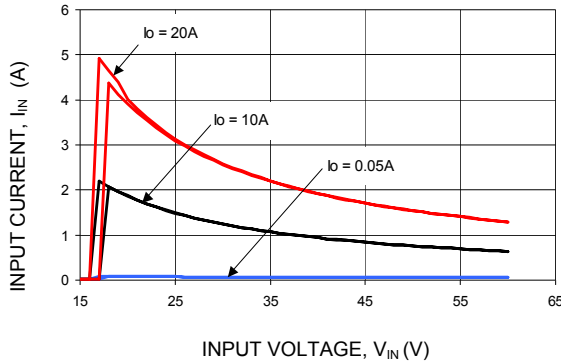

Figure 1. Typical Input characteristics at room temperature ( $V_o = 3.3\text{V}$ ).

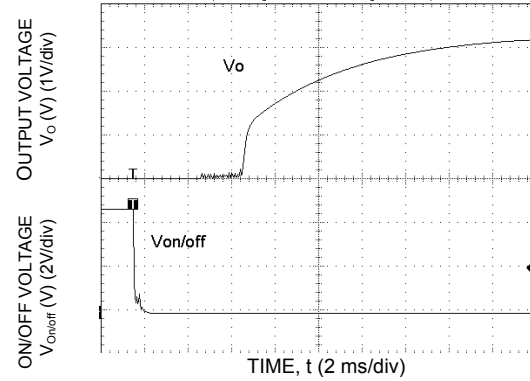

Figure 4. Typical Start-Up Characteristics from Remote ON/OFF ( $V_o = 3.3\text{V}$ ,  $I_o = 20\text{A}$ ,  $V_{in} = 48\text{V}$ ).

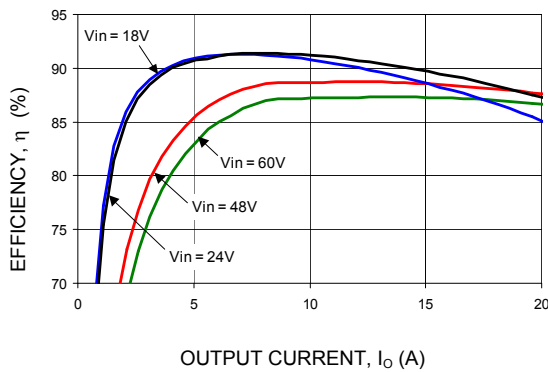

Figure 2. Typical Converter Efficiency versus Output Current at room temperature ( $V_o = 3.3\text{V}$ ).

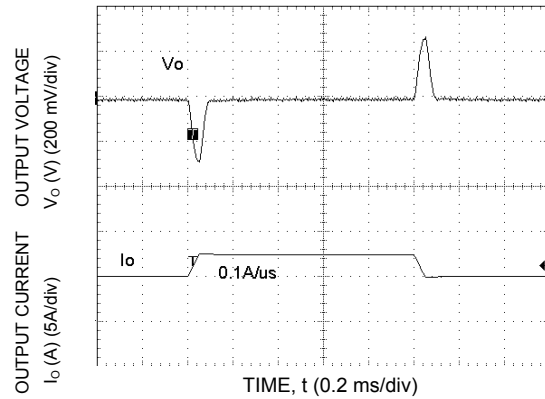

Figure 5. Transient Response to a Dynamic Load Change from 50% to 75% to 50% of full load ( $3.3\text{V}@20\text{A}$ ) at  $V_{in} = 48\text{V}$ .

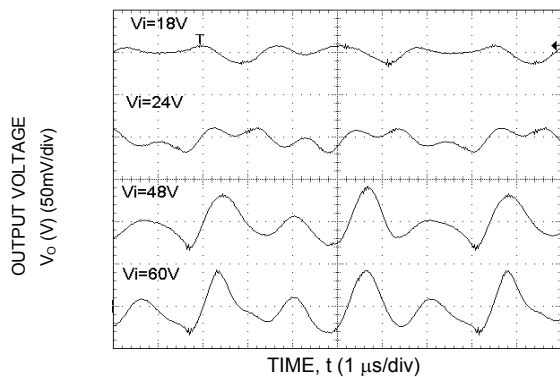

Figure 3. Typical Output Ripple and Noise at  $V_o = 3.3\text{V}$  and  $I_o = 20\text{A}$ .

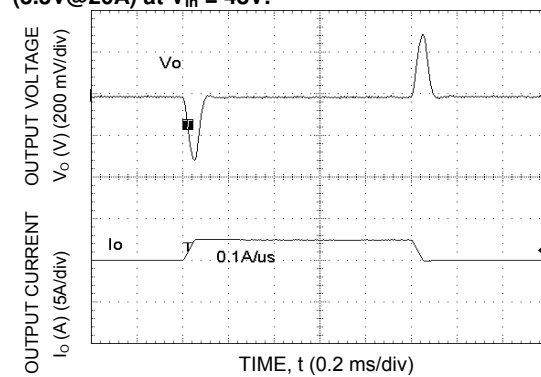

Figure 6. Transient Response to a Dynamic Load Change from 50% to 75% to 50% of full load ( $3.3\text{V}@20\text{A}$ ) at  $V_{in} = 24\text{V}$ .

Characteristic Curves (continued)

The following figures provide typical characteristics for EQD075A at  $T_A = 25^\circ\text{C}$

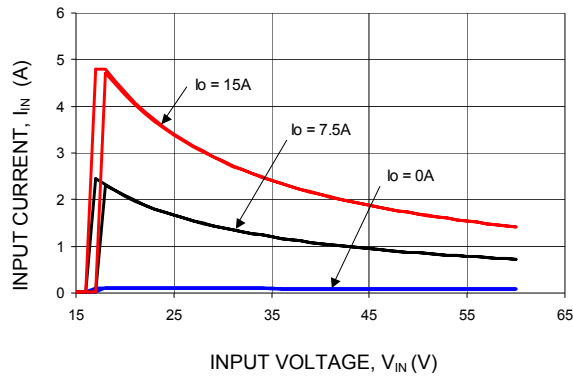

Figure 7. Typical Input characteristics at room temperature ( $V_o = 5\text{V}$ ).

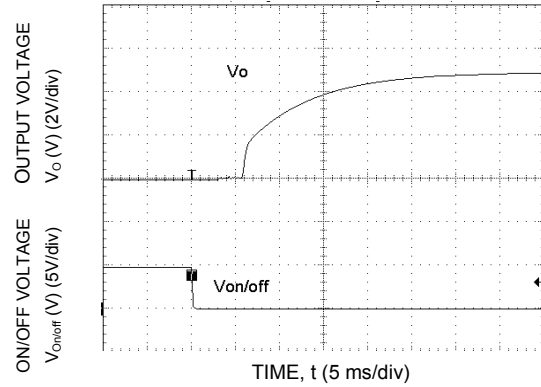

Figure 10. Typical Start-Up Characteristics from Remote ON/OFF ( $V_o = 5\text{V}$ ,  $I_o = 15\text{A}$ ,  $V_{in} = 48\text{V}$ )

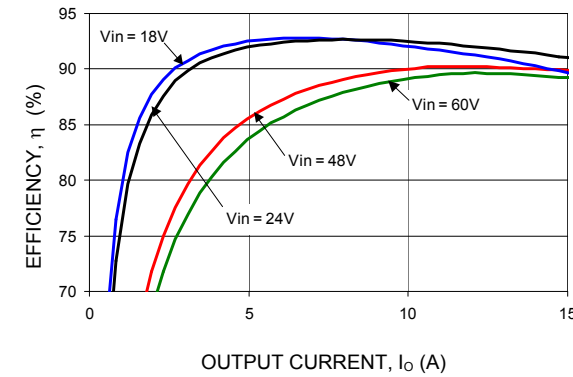

Figure 8. Typical Converter Efficiency versus Output Current at room temperature ( $V_o = 5\text{V}$ ).

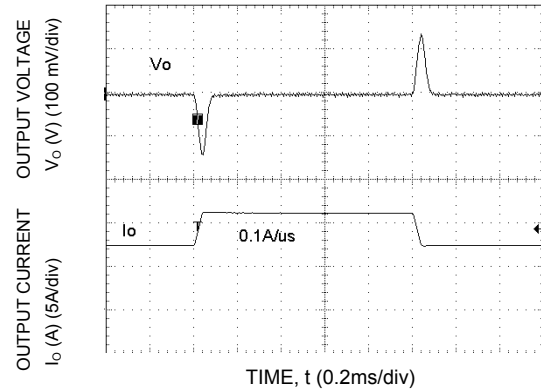

Figure 11. Transient Response to a Dynamic Load Change from 50% to 75% to 50% of full load ( $5\text{V}@15\text{A}$ ) at  $V_{in} = 48\text{V}$ .

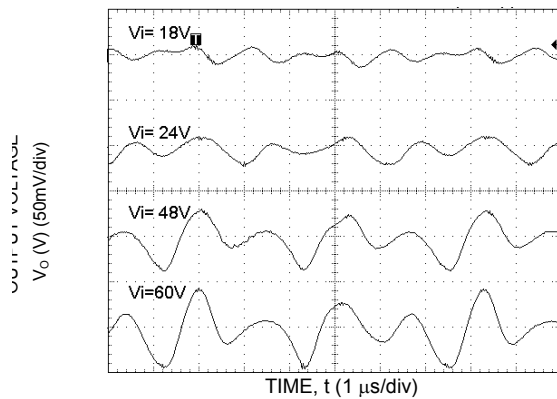

Figure 9. Typical Output Ripple and Noise at  $V_o = 5\text{V}$  and  $I_o = 15\text{A}$ .

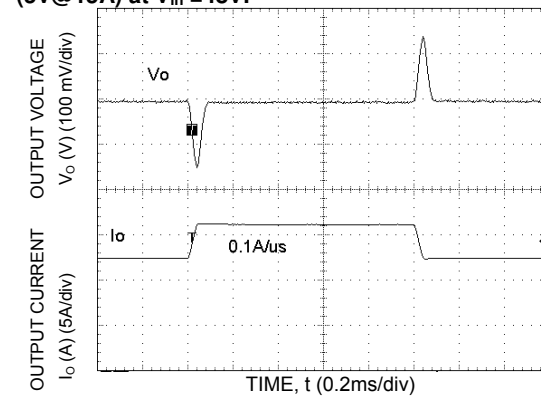
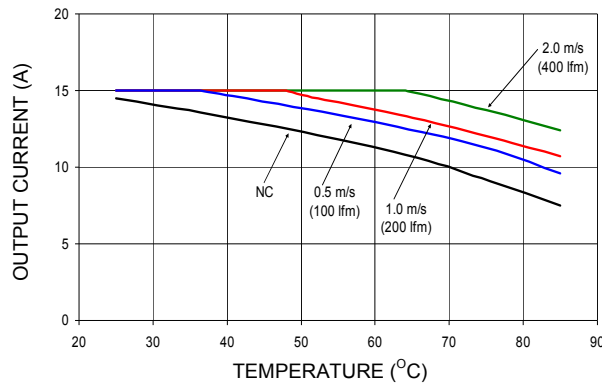

Figure 12. Transient Response to a Dynamic Load Change from 50% to 75% to 50% of full load ( $5\text{V}@15\text{A}$ ) at  $V_{in} = 24\text{V}$ .

**Characteristic Curves (continued)**

The following figures provide typical characteristics for EQD075A at  $T_A = 25^\circ\text{C}$



**Figure 13. Thermal Derating Curves for the EQD075 module at 24Vin and  $V_o=5\text{V}$ .**

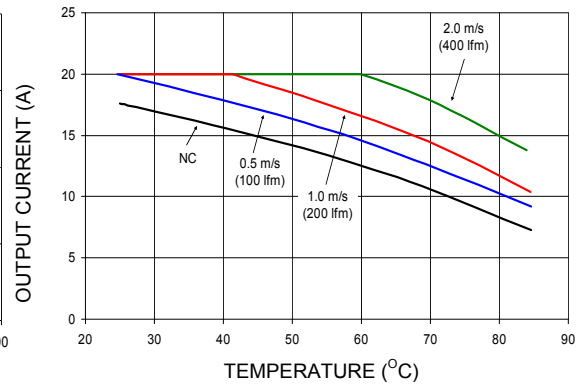

**Figure 16. Thermal Derating Curves for the EQD075 module at 48Vin and  $V_o=3.3\text{V}$ .**

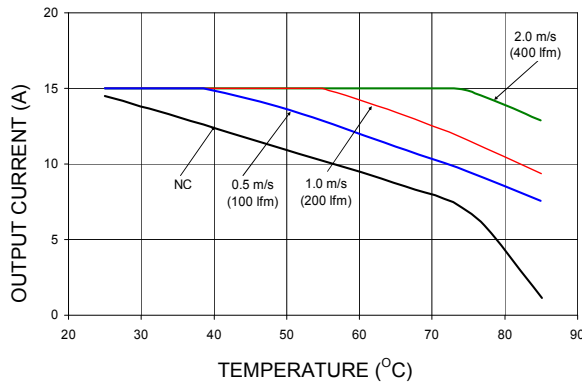

**Figure 14. Thermal Derating Curves for the EQD075 module at 48Vin and  $V_o=5\text{V}$ .**

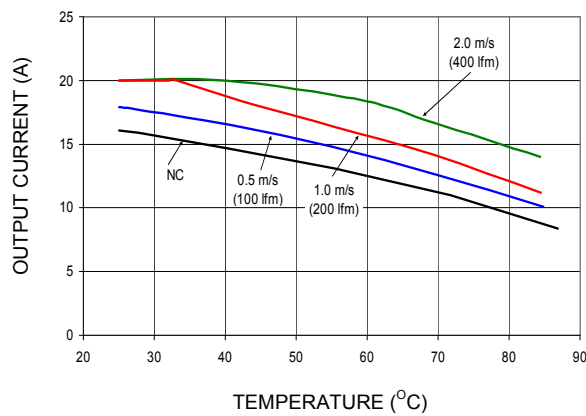

**Figure 15. Thermal Derating Curves for the EQD075 module at 24Vin and  $V_o=3.3\text{V}$ .**



## Test Configurations

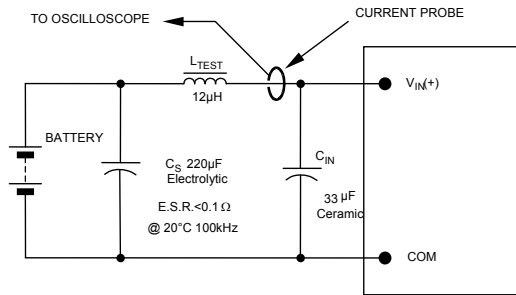

NOTE: Measure input reflected ripple current with a simulated source inductance ( $L_{TEST}$ ) of 12µH. Capacitor  $C_S$  offsets possible battery impedance. Measure current as shown above.

**Figure 17. Input Reflected Ripple Current Test Setup.**

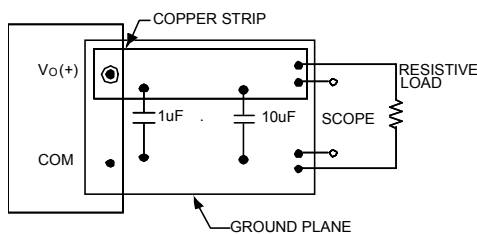

NOTE: All voltage measurements to be taken at the module terminals, as shown above. If sockets are used then Kelvin connections are required at the module terminals to avoid measurement errors due to socket contact resistance.

**Figure 18. Output Ripple and Noise Test Setup.**

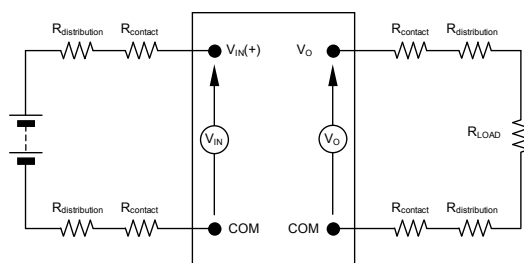

NOTE: All voltage measurements to be taken at the module terminals, as shown above. If sockets are used then Kelvin connections are required at the module terminals to avoid measurement errors due to socket contact resistance.

**Figure 19. Output Voltage and Efficiency Test Setup.**

$$\text{Efficiency } \eta = \frac{V_O \cdot I_O}{V_{IN} \cdot I_{IN}} \times 100 \%$$

## Design Considerations

### Input Filtering

The power module should be connected to a low ac-impedance source. Highly inductive source impedance can affect the stability of the power module. For the test configuration in Figure 17, a 220µF electrolytic capacitor (ESR<0.1Ω at 100 kHz), mounted close to the power module helps ensure the stability of the unit. Consult your sales representative for further applications guidelines.

### Safety Considerations

For safety-agency approval of the system in which the power module is used, the power module must be installed in compliance with the spacing and separation requirements of the end-use safety agency standard, i.e., UL60950-1, CSA C22.2 No. 60950-1-03, EN60950-1 and VDE 0805:2001-12.

These converters have been evaluated to the spacing requirements for Basic insulation, per the above safety standards; and 1500 Vdc is applied from  $V_{in}$  to  $V_{out}$  to 100% of outgoing production.

For end products connected to -48V dc nominal DC MAINS (i.e. central office dc battery plant), no further fault testing is required. For all input voltages, other than DC MAINS, where the input voltage is less than 60V dc, if the input meets all of the requirements for SELV, then:

- The output may be considered SELV. Output voltages will remain within SELV limits even with internally-generated non-SELV voltages. Single component failure and fault tests were performed in the power converters.
- One pole of the input and one pole of the output are to be grounded, or both circuits are to be kept floating, to maintain the output voltage to ground voltage within ELV or SELV limits.

The power module has ELV (extra-low voltage) outputs when all inputs are ELV.

All flammable materials used in the manufacturing of these modules are rated 94V-0, or tested to the UL60950 A.2 for reduced thickness.

The input to these units is to be provided with a maximum 6.3 A very fast-acting surface mount fuse in the unearthed lead.

## Feature Descriptions

### Remote On/Off

The EQD075 series power modules have primary referenced remote On/Off. The remote on/off is open collector compatible with the signal common referenced to the negative input. The standard remote on/off negative logic is such that a unit operates (ON) when the remote on/off signal is low or short circuit to minus  $V_{IN}$ . A module will be OFF when the remote on/off pin is open circuit or when the remote on/off signal is high. The optional positive logic remote on/off is such that a unit operates (ON) when the remote on/off signal is high or open-circuit. A unit will be OFF when the remote on/off signal is low or short-circuited to minus  $V_{IN}$ .

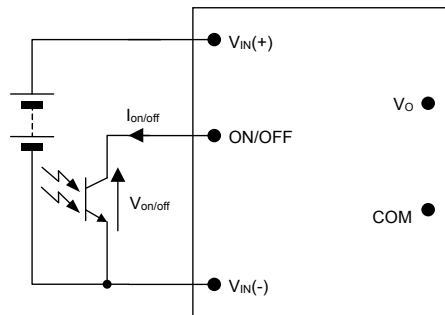

**Figure 20. Circuit configuration for using Remote On/Off Implementation.**

### Overcurrent Protection

To provide protection in a fault (output overload) condition, the unit is equipped with internal current-limiting circuitry and can endure current limiting continuously. At the point of current-limit inception, the unit enters a hiccup mode. If the unit is not configured with auto-restart, then it will latch off following the over current condition. The module can be restarted by cycling the dc input power for at least one second or by toggling the remote on/off signal for at least one second. If the unit is configured with the auto-restart option (4), it will remain in the hiccup mode as long as the overcurrent condition exists; it operates normally, once the output current is brought back into its specified range.

### Input Undervoltage Lockout

At input voltages below the input under voltage lockout limit, the module operation is disabled. The module will begin to operate at an input voltage above the under voltage lockout turn-on threshold.

### Overtemperature Protection

These modules feature an overtemperature protection circuit to safeguard against thermal damage. The

circuit shuts down and latches off the module when the maximum device reference temperature is exceeded. The module can be restarted by cycling the dc input power for at least one second or by toggling the remote on/off signal for at least one second. If the auto-restart option (4) is ordered, the module will automatically restart upon cool-down to a safe temperature.

### Over Voltage Protection

The output over voltage protection scheme of the modules has an independent over voltage loop to prevent single point of failure. This protection feature latches in the event of over voltage across the output. Cycling the on/off pin or input voltage resets the latching protection feature. If the auto-restart option (4) is ordered, the module will automatically restart upon an internally programmed time elapsing.

### Remote sense

The EQD075 series power modules have a Remote Sense feature to minimize the effects of distribution losses by regulating the voltage at the Remote Sense pin (See Figure 21). The voltage between the Sense pin and  $V_O$  pin must not exceed 0.5V. The opened sense line resistor value should be selected in range of 30 ohm – 100 ohm that eases use of external parallel load share controller.

The amount of power delivered by the module is defined as the output voltage multiplied by the output current ( $V_O \times I_O$ ). When using Remote Sense, the output voltage of the module can increase, which, if the same output is maintained, increases the power output from the module. Make sure that the maximum output power of the module remains at or below the maximum rated power. When the Remote Sense feature is not being used, connect the Remote Sense pins to the output pins of the module.

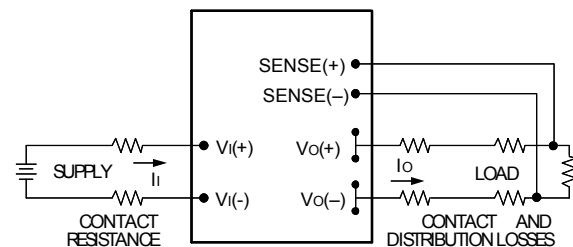

**Figure 21. Effective Circuit Configuration for remote sense operation.**

## Feature Descriptions (continued) Output Voltage Programming

The output voltage is adjustable between 3.0 to 5.5V (A version). A resistor placed between the Trim pin and Sense (+) increases the output voltage and a resistor placed between the Trim pin and Sense (-) decreases the output voltage. Figure 22 shows the circuit configuration using an external resistor. The trim resistor should be positioned close to the module. If the trim pin is not used then the pin shall be left open. If no trim resistor is connected, for the A version, the output voltage will be 5V.

The following equations determine the required external resistor value to obtain a percentage output voltage change of  $\Delta\%$ .

To decrease output voltage set point:

$$R_{trim-down} = \left( \frac{510}{\Delta\%} - 10.2 \right) K\Omega$$

Where,

$$\Delta\% = \left| \frac{V_{o,nom} - V_{desired}}{V_{o,nom}} \right| \times 100$$

$V_{desired}$  = Desired output voltage set point (V).

To increase the output voltage set point

$$R_{trim-up} = \left( \frac{5.1 * V_{o,nom} * (100 + \Delta\%)}{1.225 * \Delta\%} - \frac{510}{\Delta\%} - 10.2 \right) K\Omega$$

Although the output voltage can be increased by both the remote sense and by the trim, the maximum increase for the output voltage is not the sum of both. The maximum absolute increase in output voltage, due to simultaneous remote sense and trim increases, shall not exceed the larger of the specified individual remote sense or trim maximum limits shown in the Features Specifications table.

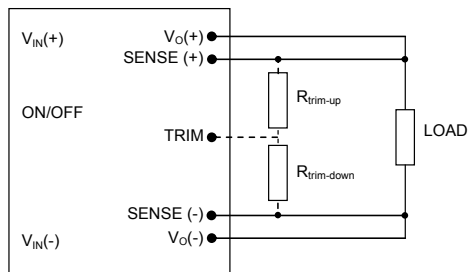

Figure 22. Circuit Configuration to program output voltage using an external resistor.

## Pre-Bias Immunity

The modules are able to start into a pre-biased output with a monotonic rise of the output voltage. During

shutdown an internal feature implemented in the module ensures there will be no reverse current.

## Thermal Considerations

Power modules operate in a variety of thermal environments; however, sufficient cooling should be provided to help ensure reliable operation. Considerations include ambient temperature, airflow, module power dissipation, and the need for increased reliability. A reduction in the operating temperature of the module will result in an increase in reliability. The thermal data is based on physical measurements taken in a wind tunnel. The test set-up is shown in Figure 23.

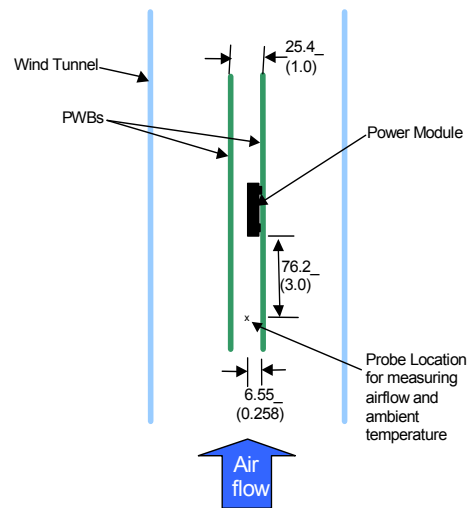

Figure 23. Thermal Test Set up.

The thermal reference point,  $T_{ref}$ , used in the specifications is shown in Figure 24. For reliable operation, this temperature should not exceed 125°C. Please refer to the Application Note "Thermal Characterization Process For Open-Frame Board-Mounted Power Modules" for a detailed discussion of thermal aspects including maximum device temperatures.

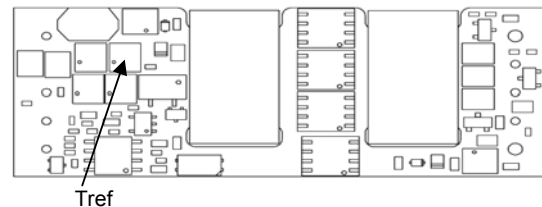

Figure 24.  $T_{ref}$  Temperature Measurement Location.

**Mechanical Outline**

Dimensions are in millimeters and [inches].

Tolerances: x.x mm ± 0.5 mm [x.xx in. ± 0.02 in.] (Unless otherwise indicated)

x.xx mm ± 0.25 mm [x.xxx in ± 0.010 in.]

**TOP VIEW**

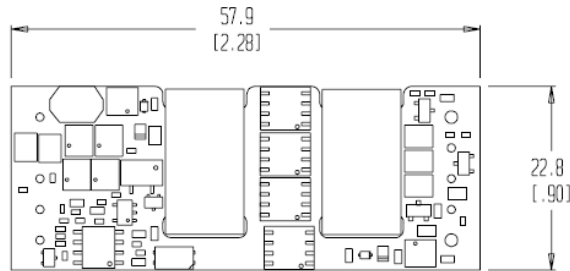

**SIDE VIEW**

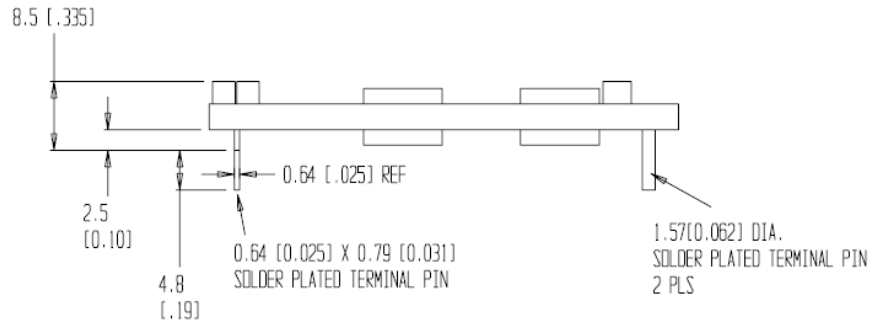

**BOTTOM VIEW**

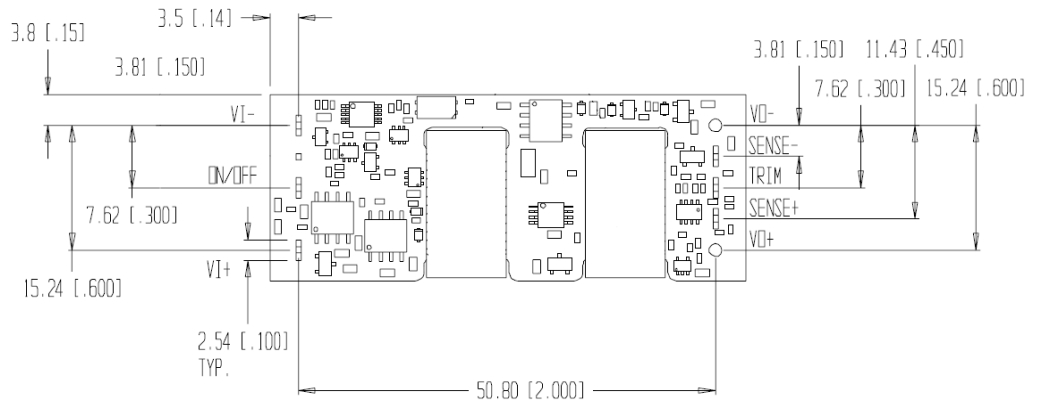

### Recommended Pad Layout

Dimensions are in millimeters and [inches].

Tolerances: x.x mm  $\pm$  0.5 mm [x.xx in.  $\pm$  0.02 in.] (Unless otherwise indicated)

x.xx mm  $\pm$  0.25 mm [x.xxx in  $\pm$  0.010 in.]

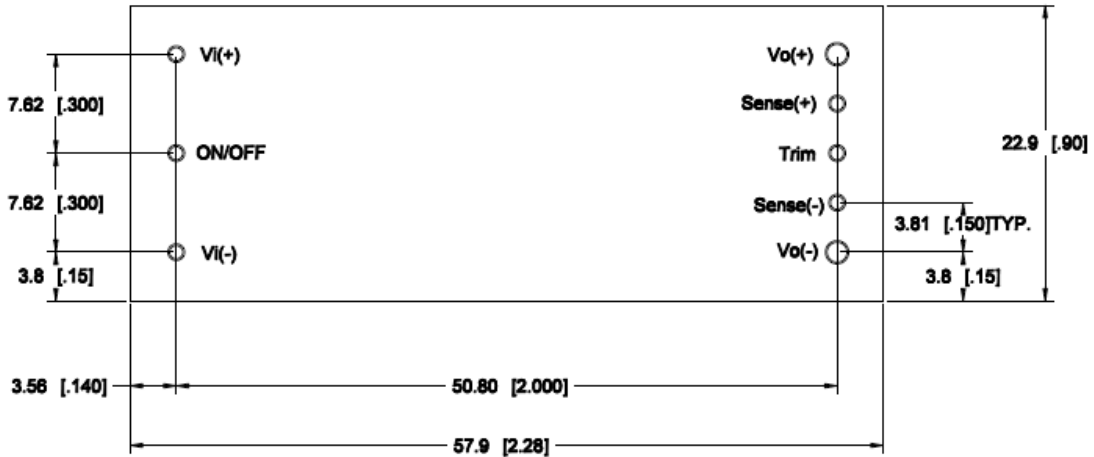

#### NOTES:

1. FOR 0.030"x0.025" PIN  
USE 0.050" DIA PLATED THROUGH HOLE
2. FOR 0.060" DIA PIN  
USE 0.078" DIA PLATED THROUGH HOLE

## Through-Hole Lead-Free Soldering Information

The RoHS-compliant through-hole products use the SAC (Sn/Ag/Cu) Pb-free solder and RoHS-compliant components. They are designed to be processed through single or dual wave soldering machines. The pins have an RoHS-compliant finish that is compatible with both Pb and Pb-free wave soldering processes. A maximum preheat rate of 3°C/s is suggested. The wave preheat process should be such that the temperature of the power module board is kept below 210°C. For Pb solder, the recommended pot temperature is 260°C, while the Pb-free solder pot is 270°C max. Not all RoHS-compliant through-hole products can be processed with paste-through-hole Pb or Pb-free reflow process. If additional information is needed, please consult with your Lineage Power System representative for more details.

## Post solder Cleaning and Drying Considerations

Post solder cleaning is usually the final circuit-board assembly process prior to electrical board testing. The result of inadequate cleaning and drying can affect both the reliability of a power module and the testability of the finished circuit-board assembly. For guidance on appropriate soldering, cleaning and drying procedures, refer to Lineage Power *Board Mounted Power Modules: Soldering and Cleaning* Application Note.

## Ordering Information

Please contact your Lineage Power Sales Representative for pricing, availability and optional features.

**Table 1. Device Code**

Product codes	Input Voltage	Output Voltage	Output Current	Efficiency	Connector Type	Comcodes
EQD075A1	18 – 60V	5/3.3V	15/20A	90%	TH	108994463
EQD075A41	18 – 60V	5/3.3V	15/20A	90%	TH	108994455
EQD075A41Z	18 – 60V	5/3.3V	15/20A	90%	TH	CC109114393
EQD075A641	18 – 60V	5/3.3V	15/20A	90%	TH	CC109126117
EQD075A641Z	18 – 60V	5/3.3V	15/20A	90%	TH	CC109147880
EQD075A81Z	18 – 60V	5/3.3V	15/20A	90%	TH	CC109129103

**Table 2. Device Options**

Option	Suffix
Negative remote on/off logic	1
Auto-restart (from OTP, OVP, OCP)	4
Pin Length: 3.68 mm ± 0.25 mm (0.145 in. ± 0.010 in.)	6
Pin Length: 2.79 mm ± 0.25 mm (0.110 in. ± 0.010 in.)	8
RoHS Compliant	Z



**World Wide Headquarters**  
Lineage Power Corporation  
601 Shiloh Road, Plano, TX 75074, USA  
**+1-800-526-7819**  
(Outside U.S.A.: **+1-972-244-9428**)  
[www.lineagepower.com](http://www.lineagepower.com)  
**e-mail: techsupport1@lineagepower.com**

**Asia-Pacific Headquarters**  
Tel: +65 6593 7211

**Europe, Middle-East and Africa Headquarters**  
Tel: +49 89 878067-280

**India Headquarters**  
Tel: +91 80 28411633

Lineage Power reserves the right to make changes to the product(s) or information contained herein without notice. No liability is assumed as a result of their use or application. No rights under any patent accompany the sale of any such product(s) or information.

Lineage Power DC-DC products are protected under various patents. Information on these patents is available at [www.lineagepower.com/patents](http://www.lineagepower.com/patents).

© 2009 Lineage Power Corporation. (Plano, Texas) All International Rights Reserved.