

CC2531 USB Hardware User's Guide



swru221a

Table of Contents

1	Introduction	3
2	About this Manual	3
3	Acronyms	4
4	Definitions	5
5	Getting Started	7
6	Using SmartRF05EB as an In-Circuit Emulator (ICE)	9
6.1	The Debug Interface.....	9
7	USB Dongle Hardware Description	10
7.1	User Interface.....	10
7.2	Debug Connector	10
7.3	RF Performance of Antenna	11
8	USB Dongle Reference Design and Schematics	12
9	References	13
10	General Information	14
10.1	Document History	14

1 Introduction

Thank you for purchasing a CC2530 Development Kit.

The CC2530 is Texas Instrument's second generation ZigBee/IEEE 802.15.4 compliant System-on-Chip with an optimized 8051 MCU core and radio for the 2.4 GHz unlicensed ISM/SRD band. This device enables industrial grade applications by offering state-of-the-art noise immunity, excellent link budget, operation up to 125 degrees and low voltage operation.

In addition, the CC2530 provides extensive hardware support for packet handling, data buffering, burst transmissions, data encryption, data authentication, clear channel assessment, link quality indication and packet timing information. The CC2530 product folder on the web [10] has more information, with datasheets, user guides and application notes.

The CC2531 is identical to CC2530, with the addition of a built in full speed USB 2.0 compliant interface.

The CC2530 Development Kit includes all the necessary hardware to properly evaluate, demonstrate, prototype and develop software targeting not only IEEE802.15.4 or ZigBee compliant applications, but also proprietary applications for which a DSSS radio is required or wanted.

2 About this Manual

This manual covers the CC2531 USB dongle found in the CC2530 Development Kit and the CC2530 ZigBee Development Kit.

The manual covers the CC2531 USB Dongle hardware component of a USB development framework. Please refer to [3] for a description of the accompanying USB Firmware Library and application examples.

3 Acronyms

CDC	Communications Device Class
DK	Development Kit
EB	Evaluation Board
EM	Evaluation Module
EMK	Evaluation Module Kit
HID	Human Interface Device
IC	Integrated Circuit
ICE	In Circuit Emulator
KB	Kilo Byte (1024 byte)
LED	Light Emitting Diode
LPRF	Low Power RF
MCU	Micro Controller
NC	Not connected
RF	Radio Frequency
RX	Receive
SoC	System on Chip
TI	Texas Instruments
TX	Transmit
UART	Universal Asynchronous Receive Transmit
USB	Universal Serial Bus

4 Definitions

SmartRF05EB

The SmartRF05EB (evaluation board) is the main board in the kit with a wide range of user interfaces:

- 3x16 character serial LCD
- Full speed USB 2.0 interface
- UART
- LEDs
- Serial Flash
- Potentiometer
- Joystick
- Buttons

The EB is the platform for the evaluation modules (EM) and can be connected to the PC via USB to control the EM.

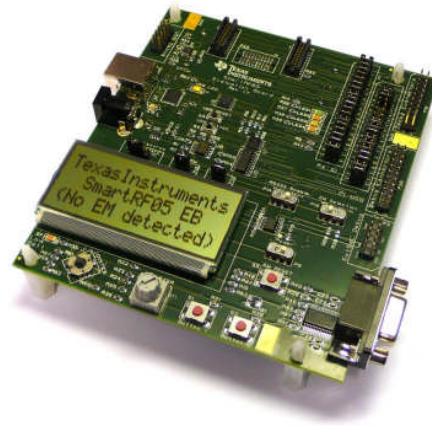

CC2530EM

The CC2530EM (evaluation module) contains the RF IC and necessary external components and matching filters for getting the most out of the radio. The module can be plugged into the SmartRF05EB. **Use the EM as reference design for RF layout.** The schematics are included at the end of this document and the layout files can be found on the web CC2530 Product Page [10].

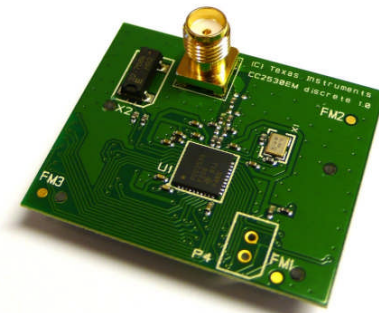

CC2531 USB Dongle

The CC2531 USB Dongle is a fully operational USB device that can be plugged into a PC. The dongle has 2 LEDs, two small push-buttons and connector holes that allow connection of external sensors or devices. The dongle also has a connector for programming and debugging of the CC2531 USB controller.

The dongle comes preprogrammed with firmware such that it can be used as a packet sniffer device.



Antenna

2.4 GHz antenna Titanis from Antenova.



SoC	System on Chip. A collective term used to refer to Texas Instruments ICs with on-chip MCU and RF transceiver. Used in this document to reference the CC2530 and 2531.
ICE	In Circuit Emulator. ICE functionality is built into the SmartRF05EB and the CC Debugger
USB software application examples	Application examples using the CC2531 USB Dongle together with a CC2530EM.
USB Firmware Library	A library of low level USB firmware which is used by all the USB software examples.

5 Getting Started

Make sure to install SmartRF Studio **before** connecting the SmartRF05EB to a PC. By installing it, the required Windows drivers will be provided when connecting the SmartRF05EB.

SmartRF Studio [4] is a PC application for Windows that helps you find and adjust the radio register settings. Please see [4] for instructions on downloading and installation.

The dongle comes preprogrammed with firmware such that it can be used as a packet sniffer device. For programming the device with other firmware an external ICE is needed. The SmartRF05EB¹ can be used to program the USB dongle. The CC2531 has a 2 wire debug interface that is used for chip programming and debugging. When connecting this interface to the SmartRF05EB, the CC2531 can be programmed from the SmartRF Flash Programmer software [2] and debugged from IAR Embedded Workbench. To connect the CC2531 USB Dongle to the SmartRF05EB, follow these steps:

1. Turn off the SmartRF05EB power by moving the power switch shown in Figure 2 to the left position.
2. Remove any evaluation modules (EMs) attached to the SmartRF05EB.
3. Connect the SmartRF05EB to a PC with the supplied USB cable.
4. Connect the USB Dongle to the ExtSoC Debug header (P3) on SmartRF05EB with the supplied 10 pin cable and adapter board (see Figure 1). Make sure pin 1 on the dongle is connected to pin 1 on P3. This cable connects the debug interface and GND between the two devices; however the USB Dongle is not powered through this cable.
5. Power the CC2531 USB Dongle. To power the dongle there are two options:
 - **Powered with a USB Cable**
Use the supplied USB extension cable to connect the USB Dongle to the PC (see Figure 1).
 - **Powered from the SmartRF05EB**
Mount resistor R2 on the CC2531 USB Dongle and resistor R30 on the SmartRF05EB.
The CC2531 USB Dongle should only be powered by one of the two sources at a time. Do not connect the USB cable to the USB Dongle while it is powered from the SmartRF05EB.
6. Turn on the power on the SmartRF05EB (see Figure 2).

¹ It is also possible to use the SmartRF04EB or the CC Debugger to program the device.

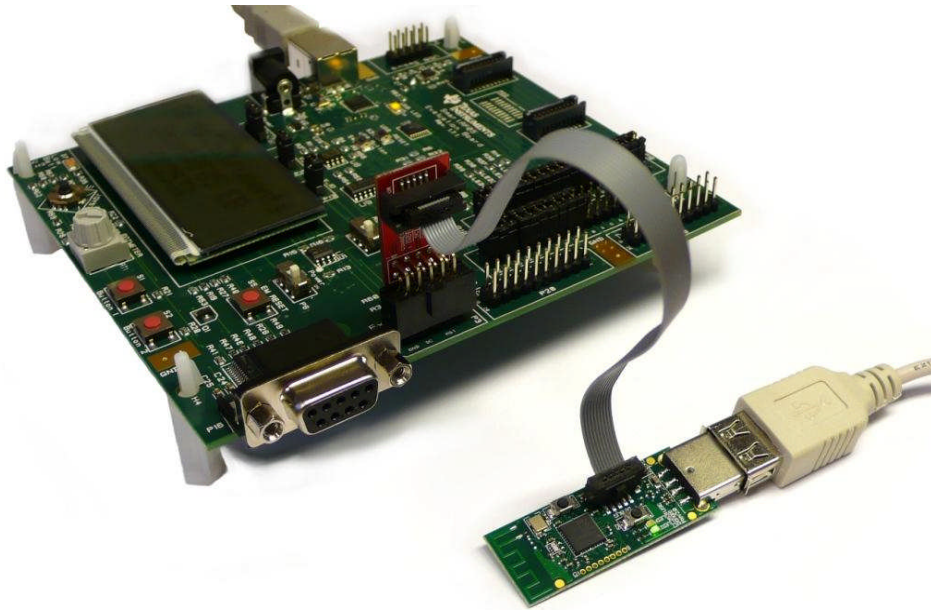

Figure 1 - CC2531 USB Dongle connected to SmartRF05EB

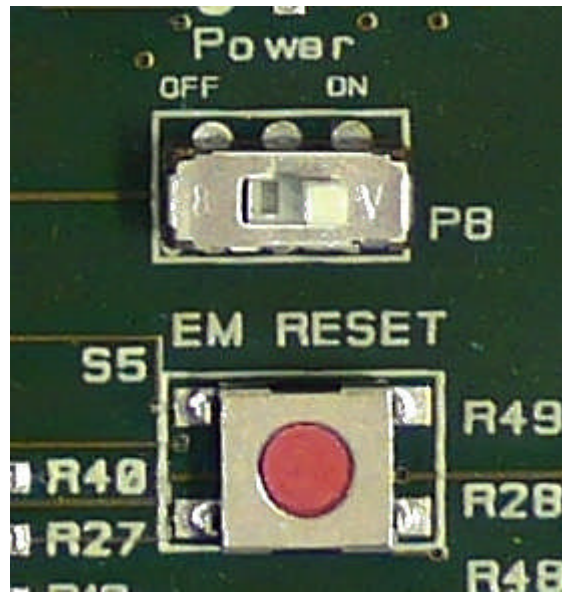

Figure 2 - SmartRF05EB power switch, power on.

The CC2531 can now be programmed with the SmartRF Flash Programmer software. The firmware on the CC2531 can also be debugged using the IAR Embedded Workbench debugger. Please see the “SmartRF Flash Programmer User’s Manual” for more details [2].

Please see the “CC2530 Development Kit User Manual” [1] for more information on the SmartRF05EB and how to use the CC2530EM.

6 Using SmartRF05EB as an In-Circuit Emulator (ICE)

The debug interface on the SmartRF05EB is controlled by the USB MCU. This allows both programming and an emulator interface over USB, which makes the SmartRF05EB usable as an ICE for the CC2531 dongle.

To use the SmartRF05EB as ICE, the IAR Embedded Workbench software for 8051 architecture (EW8051) must be installed. The Embedded Workbench is an integrated development environment with a complete tool-chain such as C Compiler, Simulator, and ICE debugger. Please see [1] for instructions on how to set up the ICE debugger for use as an ICE.

When the SmartRF05EB with a SoC is connected to a PC with the USB port, the debugger in IAR EW8051 will connect to it when started. If several SmartRF05EBs are connected to USB ports simultaneously, a selection window will display the connected evaluation boards, and the user can select which device to load.

6.1 The Debug Interface

For custom PCB's with the CC2531 SoC, it is recommended to include a pin header or test points to allow in-circuit emulation or programming using a SmartRF05EB or other 3rd party programming tools. The USB Dongle can be used as a reference.

VDD note: The SmartRF05EB includes a voltage converter to support programming and debugging of external systems with different voltage than the SmartRF05EB.

When using SmartRF05EB as emulator for external target debugging any evaluation module (EM) must be removed.

Figure 3 shows the required signal for a minimum connector layout on external target.

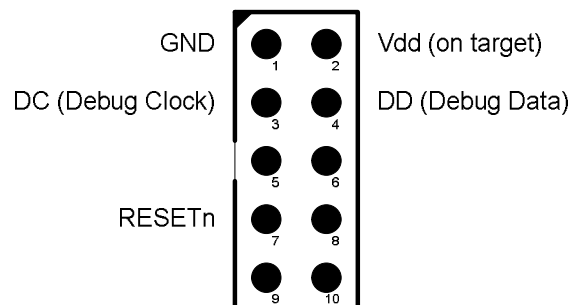

Figure 3 - Minimum Debug Connector Pinout (top view)

7 USB Dongle Hardware Description

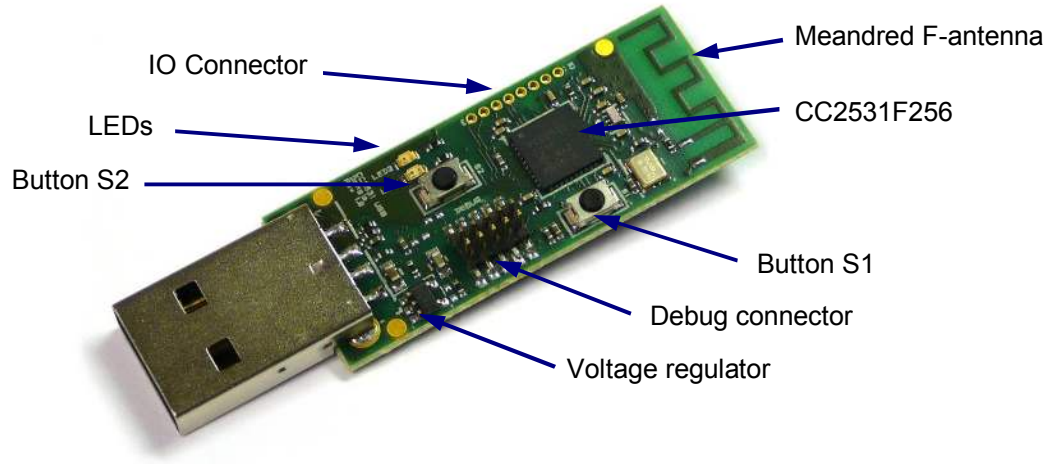

Figure 4 - CC2531 USB Dongle

7.1 User Interface

The CC2531 USB Dongle has two buttons and two LEDs that can be used to interact with the user. Table 1 shows which CC2531 signals are connected to what IO on the dongle.

IO Connector	CC2531
1	P0.2
2	P0.3
3	P0.4
4	P0.5
5	P1.7
6	P1.6
7	P1.5
8	P1.4

Dongle User IO	CC2531
Green LED	P0.0
Red LED	P1.1
Button S1	P1.2
Button S2	P1.3

Table 1 - CC2531 USB Dongle Pinout

7.2 Debug Connector

The CC2531 USB dongle can be connected to a SmartRF Evaluation Board for debugging and programming.

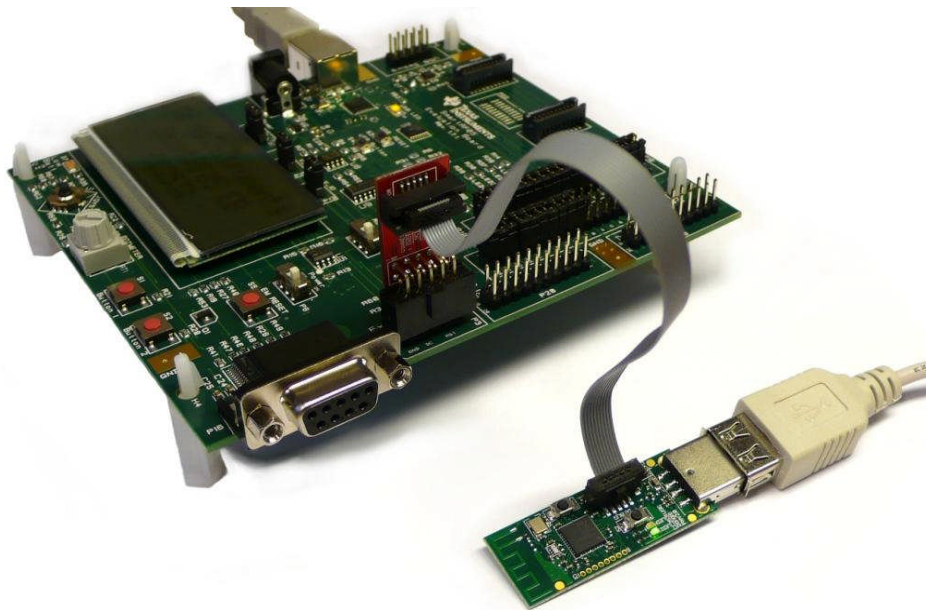

Figure 5 - CC2531 USB Dongle connected to SmartRF05EB

The debug connector on the CC2531 USB Dongle matches the debug connector on the SmartRF05EB (and the CC Debugger). Note that, by default, the CC2531 dongle is not powered through the debug connector, so an external power source must be used while programming. The easiest solution is to connect it to a USB port on the PC. Alternatively, resistor R2 can be mounted. The table below shows the pin out of the debug connector.

Pin #	Connection
1	GND
2	VCC
3	CC2531 P2.2 (DC)
4	CC2531 P2.1 (DD)
5	NC
6	NC
7	CC2531 RESET
8	NC
9	Optional external VCC (R2 must be mounted)
10	NC

Table 2 - CC2531 USB Dongle Debug Connector

7.3 RF Performance of Antenna

While the CC2531 USB Dongle has a PCB antenna designed as a meandered inverted F antenna.

The performance of the PCB antenna on the USB Dongle will be affected by its nearby surroundings. Therefore, when plugged into different computers or a USB extension cable differences in the RF performance must be expected. Also, if the USB Dongle is put inside a casing, the material and design of the enclosure will influence the antenna's performance. For the CC2531 USB Dongle the maximum antenna gain measured is 5.3 dBi. This means that duty cycling or reduction of output power might be needed to ensure compliance with regulatory limits. Please see [8] for more information about SRD regulations in the 2.4 GHz ISM band. The performance of the antenna of the CC2531 USB Dongle is further described in [9].

8 USB Dongle Reference Design and Schematics

Refer to [1] for the schematics of the CC2531 USB Dongle.

9 References

- [1] CC2530 DK Development Kit User Manual ([swru208](#))
- [2] SmartRF Flash Programmer ([swrc044](#))
- [3] SmartRF Packet Sniffer ([swrc045](#))
- [4] SmartRF Studio ([swrc046](#))
- [5] CC USB Firmware Library and Examples ([swrc088](#))
- [6] CC USB Software Examples User's Guide ([swru222](#))
- [7] SmartRF05EB User's Guide ([swru210](#))
- [8] AN032 – SRD Regulation for License-Free Transceiver Operation in the 2.4 GHz Band ([swra060](#))
- [9] AN043 – Small Size 2.4 GHz PCB Antenna ([swra117](#))
- [10] CC2530 Product Web Site (<http://focus.ti.com/docs/prod/folders/print/cc2530.html>)

10 General Information

10.1 Document History

Revision	Date	Description/Changes
SWRU221A	2009.07.31	Updated info about how to connect dongle to SmartRF05EB. Corrected typos.
SWRU221	2009.05.08	Initial release

IMPORTANT NOTICE

Texas Instruments Incorporated and its subsidiaries (TI) reserve the right to make corrections, modifications, enhancements, improvements, and other changes to its products and services at any time and to discontinue any product or service without notice. Customers should obtain the latest relevant information before placing orders and should verify that such information is current and complete. All products are sold subject to TI's terms and conditions of sale supplied at the time of order acknowledgment.

TI warrants performance of its hardware products to the specifications applicable at the time of sale in accordance with TI's standard warranty. Testing and other quality control techniques are used to the extent TI deems necessary to support this warranty. Except where mandated by government requirements, testing of all parameters of each product is not necessarily performed.

TI assumes no liability for applications assistance or customer product design. Customers are responsible for their products and applications using TI components. To minimize the risks associated with customer products and applications, customers should provide adequate design and operating safeguards.

TI does not warrant or represent that any license, either express or implied, is granted under any TI patent right, copyright, mask work right, or other TI intellectual property right relating to any combination, machine, or process in which TI products or services are used. Information published by TI regarding third-party products or services does not constitute a license from TI to use such products or services or a warranty or endorsement thereof. Use of such information may require a license from a third party under the patents or other intellectual property of the third party, or a license from TI under the patents or other intellectual property of TI.

Reproduction of TI information in TI data books or data sheets is permissible only if reproduction is without alteration and is accompanied by all associated warranties, conditions, limitations, and notices. Reproduction of this information with alteration is an unfair and deceptive business practice. TI is not responsible or liable for such altered documentation. Information of third parties may be subject to additional restrictions.

Resale of TI products or services with statements different from or beyond the parameters stated by TI for that product or service voids all express and any implied warranties for the associated TI product or service and is an unfair and deceptive business practice. TI is not responsible or liable for any such statements.

TI products are not authorized for use in safety-critical applications (such as life support) where a failure of the TI product would reasonably be expected to cause severe personal injury or death, unless officers of the parties have executed an agreement specifically governing such use. Buyers represent that they have all necessary expertise in the safety and regulatory ramifications of their applications, and acknowledge and agree that they are solely responsible for all legal, regulatory and safety-related requirements concerning their products and any use of TI products in such safety-critical applications, notwithstanding any applications-related information or support that may be provided by TI. Further, Buyers must fully indemnify TI and its representatives against any damages arising out of the use of TI products in such safety-critical applications.

TI products are neither designed nor intended for use in military/aerospace applications or environments unless the TI products are specifically designated by TI as military-grade or "enhanced plastic." Only products designated by TI as military-grade meet military specifications. Buyers acknowledge and agree that any such use of TI products which TI has not designated as military-grade is solely at the Buyer's risk, and that they are solely responsible for compliance with all legal and regulatory requirements in connection with such use.

TI products are neither designed nor intended for use in automotive applications or environments unless the specific TI products are designated by TI as compliant with ISO/TS 16949 requirements. Buyers acknowledge and agree that, if they use any non-designated products in automotive applications, TI will not be responsible for any failure to meet such requirements.

Following are URLs where you can obtain information on other Texas Instruments products and application solutions:

Products

Amplifiers	amplifier.ti.com
Data Converters	dataconverter.ti.com
DLP® Products	www.dlp.com
DSP	dsp.ti.com
Clocks and Timers	www.ti.com/clocks
Interface	interface.ti.com
Logic	logic.ti.com
Power Mgmt	power.ti.com
Microcontrollers	microcontroller.ti.com
RFID	www.ti-rfid.com
RF/IF and ZigBee® Solutions	www.ti.com/lprf

Applications

Audio	www.ti.com/audio
Automotive	www.ti.com/automotive
Broadband	www.ti.com/broadband
Digital Control	www.ti.com/digitalcontrol
Medical	www.ti.com/medical
Military	www.ti.com/military
Optical Networking	www.ti.com/opticalnetwork
Security	www.ti.com/security
Telephony	www.ti.com/telephony
Video & Imaging	www.ti.com/video
Wireless	www.ti.com/wireless

Mailing Address: Texas Instruments, Post Office Box 655303, Dallas, Texas 75265
Copyright © 2009, Texas Instruments Incorporated