

Features

- High reliability
- General purpose leads
- Peak wavelength $\lambda_p=880\text{nm}$
- Mechanically and spectrally matched to the phototransistor
- Low forward voltage
- High radiant intensity

Description

- The infrared emitting diode (880nm) is a high intensity diode, molded in a water clear transparent plastic package.
- The device is spectrally matched with silicon photodiode and phototransistor.

Applications

- Optoelectronic Switch
- IR Touch-Panel
- Industrial IR Equipment
- Consumer Electronics
- High Speed IR Communications

Package Dimensions in mm

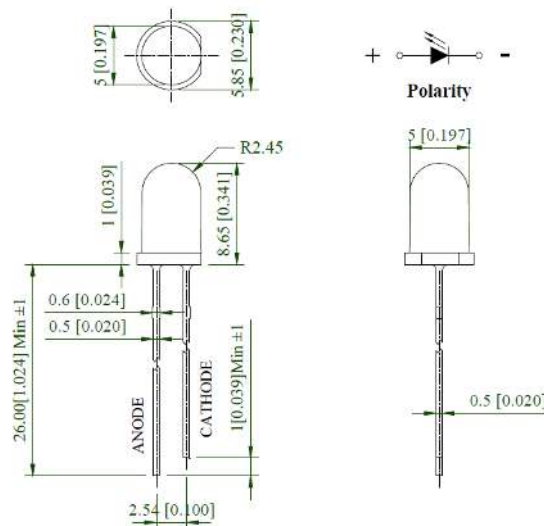

Notes:

1. All dimensions are in millimeters (inches).
2. Tolerance is ± 0.25 mm (.010 ") unless otherwise noted.

Figure 1. INL-5AMIR15 Package Dimensions

Absolute Maximum Rating at 25°C (Note 1)

Product	Emission Color	P_d (mW)	I_f (mA)	I_{FP}^* (A)	V_R (V)	T_{OP} (°C)	T_{ST} (°C)
INL-5AMIR15	Infrared	160	100	1	5	-40°C~+80°C	-40°C~+85°C

Notes

1. Condition for I_{FP} is pulse of 1/10 duty and 1kHz frequency

Electrical Characteristics $T_A = 25^\circ\text{C}$ (Note 1)

Product	Emission Color	I_f (mA)	V_F (V)		λ (nm)			Viewing Angle	E_e (mW/sr)	
			min	max	λ_D	λ_P	$\Delta\lambda$	$2\theta_{1/2}$	min	typ.
INL-5AMIR15	Infrared	20	1.0	1.6	-	880	45	15	7.8	12

Notes

1. Performance guaranteed only under conditions listed in above tables.

ESD Precaution

ATTENTION: Electrostatic Discharge (ESD) protection



The symbol above denotes that ESD precaution is needed. ESD protection for GaP and AlGaAs based chips is necessary even though they are relatively safe in the presence of low static-electric discharge. Parts built with AlInGaP, GaN, or/and InGaN based chips are STATIC SENSITIVE devices. ESD precaution must be taken during design and assembly. If manual work or processing is needed, please ensure the device is adequately protected from ESD during the process.

Please be advised that normal static precautions should be taken in the handling and assembly of this device to prevent damage or degradation which may be induced by electrostatic discharge (ESD).

Typical Characteristic Curves

Spectral Distribution

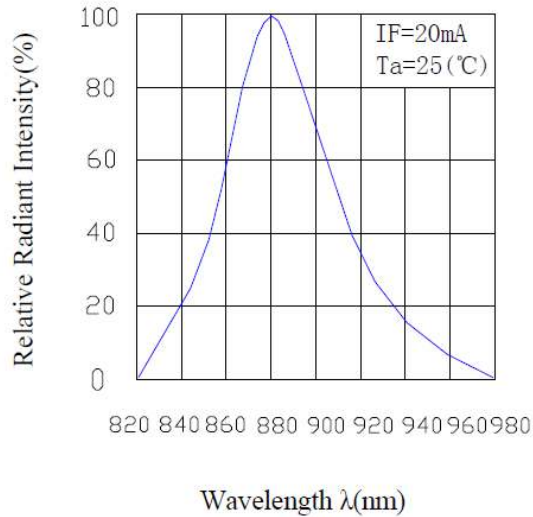

Forward Current & Forward Voltage

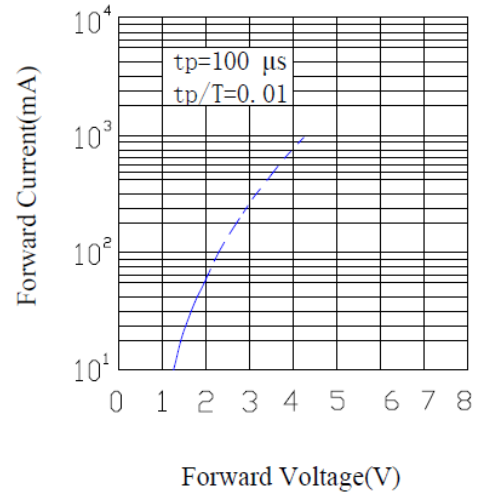

Peak Emission Wavelength & Ambient Temperature

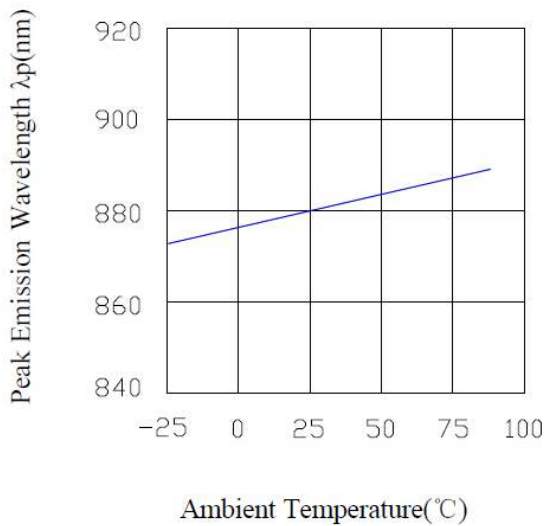

Forward Current & Ambient Temperature

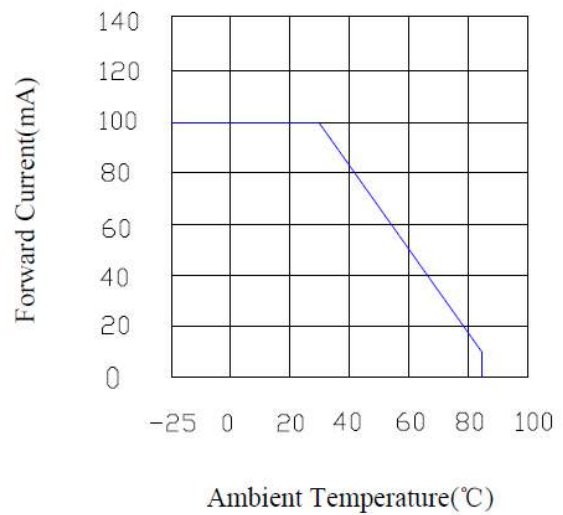

Relative Intensity &
Forward Current

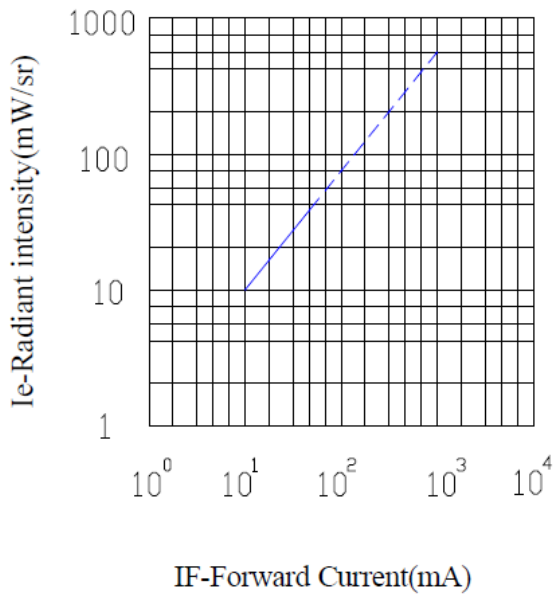

Relative Intensity &
Ambient Temperature(°C)

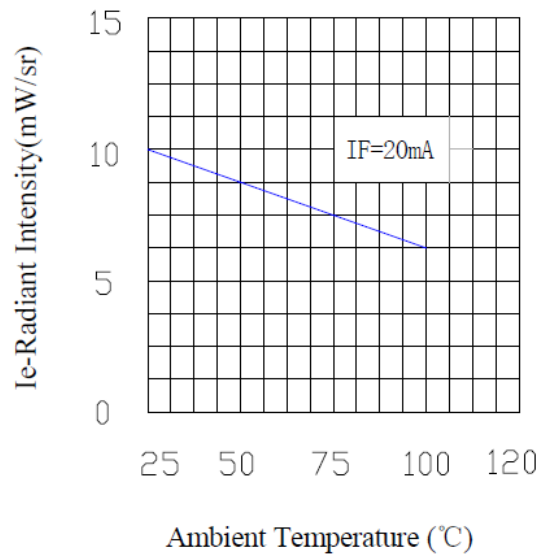

Forward Voltage &
Ambient Temperature(°C)

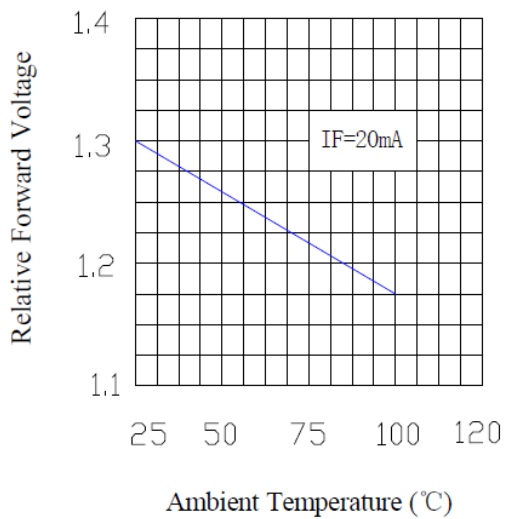

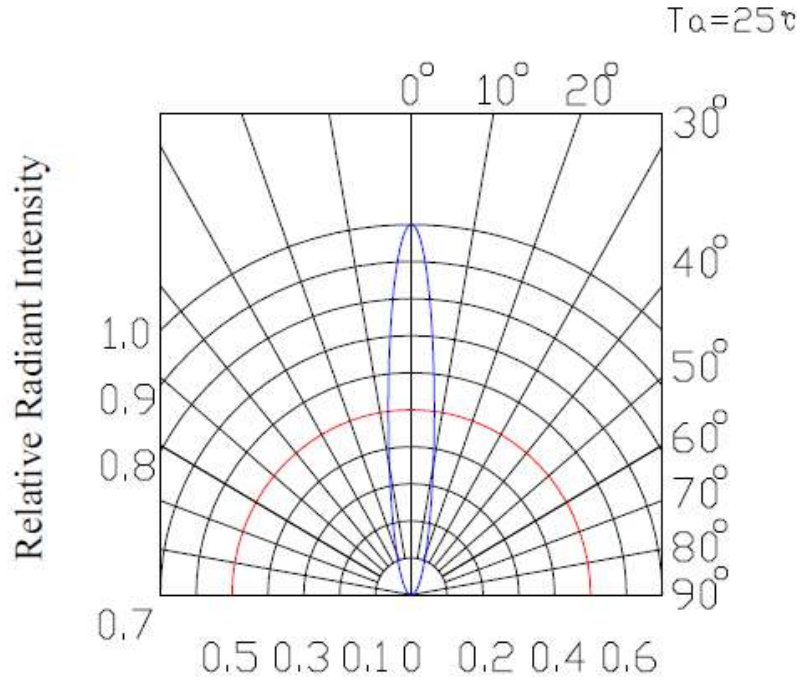
Typical Characteristic Curves – Radiation Pattern

Ordering Information

Product	Emission Color	Technology	Test Current I_F (mA)	Radiant Intensity E_e (mW/sr) (Typ.)	Forward Voltage V_F (V) (Typ.)	Orderable Part Number
INL-5AMIR15	Infrared	AlGaAs	20	12	1.3	INL-5AMIR15

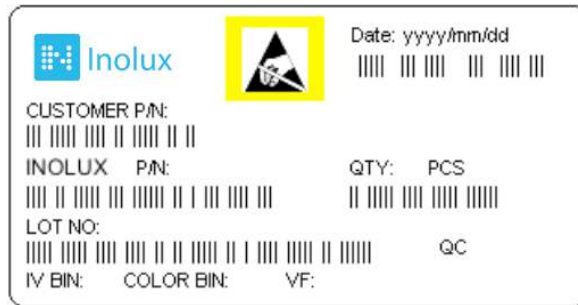
Label Specifications



Inolux P/N:

I	N	L	-	5	A	-	MIR	1	5	.	X	X	X	X
Inolux Lamp Type			Package	Lens	Color	View Angle				Customized Stamp-off				
			5A = standard 5mm	(Blank) = clear	MIR = 880nm	15 = 15 deg.								

Lot No.:

Z	2	0	1	7	01	24	001
Internal Tracker	Year (2017, 2018,)				Month	Date	Serial

Reliability

Item	Frequency/ lots/ samples/ failures	Standards Reference	Conditions
Precondition	For all reliability monitoring tests according to JEDEC Level 2	J-STD-020	1.) Baking at 85°C for 24hrs 2.) Moisture storage at 85°C/ 60% R.H. for 168hrs
Solderability	1Q/ 1/ 22/ 0	JESD22-B102-B And CNS-5068	Accelerated aging 155°C/ 24hrs Tinning speed: 2.5+0.5cm/s Tinning: A: 215°C/ 3+1s or B: 260°C/ 10+1s
Resistance to soldering heat		CNS-5067	Dipping soldering terminal only Soldering bath temperature A: 260+/-5°C; 10+/-1s B: 350+/-10°C; 3+/-0.5s
Operating life test	1Q/ 1/ 40/ 0	CNS-11829	1.) Precondition: 85°C baking for 24hrs 85°C/ 60%R.H. for 168hrs 2.) Tamb25°C; IF=20mA; duration 1000hrs
High humidity, high temperature bias	1Q/ 1/ 45/ 0	JESD-A101-B	Tamb: 85°C Humidity: 85% R.H., IF=5mA Duration: 1000hrs
High temperature bias	1Q/ 1/ 20	IN specs.	Tamb: 55°C IF=20mA Duration: 1000hrs
Pulse life test	1Q/ 1/ 40/ 0		Tamb25°C, If=20mA,, Ip=100mA, Duty cycle=0.125 (tp=125 μs, T=1sec) Duration 500hrs)
Temperature cycle	1Q/ 1/ 76/ 0	JESD-A104-A IEC 68-2-14, Nb	A cycle: -40 degree C 15min; +85 degree C 15min Thermal steady within 5 min.. 300 cycles 2 chamber/ Air-to-air type
High humidity storage test	1Q/ 1/ 40/ 0	CNS-6117	60+3°C 90+5/-10% R.H. for 500hrs
High temperature storage test	1Q/ 1/ 40/ 0	CNS-554	100+10°C for 500hrs
Low temperature storage test	1Q/ 1/ 40/ 0	CNS-6118	-40+5°C for 500hrs



Revision History

Changes since last revision	Page	Version No.	Revision Date
Initial Release		1.0	01-19-2019

DISCLAIMER

INOLUX reserves the right to make changes without further notice to any products herein to improve reliability, function or design. INOLUX does not assume any liability arising out of the application or use of any product or circuit described herein; neither does it convey any license under its patent rights, nor the rights of others.

LIFE SUPPORT POLICY

INOLUX's products are not authorized for use as critical components in life support devices or systems without the express written approval of the President of INOLUX or INOLUX CORPORATION. As used herein:

1. Life support devices or systems are devices or systems which, (a) are intended for surgical implant into the body, or (b) support or sustain life, and (c) whose failure to perform when properly used in accordance with instructions for use provided in the labeling, can be reasonably expected to result in a significant injury of the user.
2. A critical component in any component of a life support device or system whose failure to perform can be reasonably expected to cause the failure of the life support device or system, or to affect its safety or effectiveness.