

Liquid Series Thermoelectric Cooler Assembly

The LA-115-24-02 thermoelectric cooler assembly offers dependable, compact performance by cooling objects via liquid to transfer heat. Heat is absorbed through a liquid heat exchanger and dissipated thru a high density heat sink equipped with an air ducted shroud and brand name fan. The thermoelectric modules are custom designed to achieve a high coefficient of performance (COP) to minimize power consumption. It has a maximum Qc of 113 Watts when $\Delta T = 0$ and a maximum ΔT of 42 °C at $Q_c = 0$. The liquid heat exchanger is designed to accommodate distilled water with glycol. Corrosion resistant turbulators are enclosed inside channels to increase heat transfer. Mating port adaptors are sold separately.

Features

- Compact design
- Precise temperature control
- Reliable solid-state operation
- DC operation
- RoHS-compliant

Applications

- Medical Diagnostics
- Industrial Lasers
- Medical Lasers
- Analytical Instrumentation

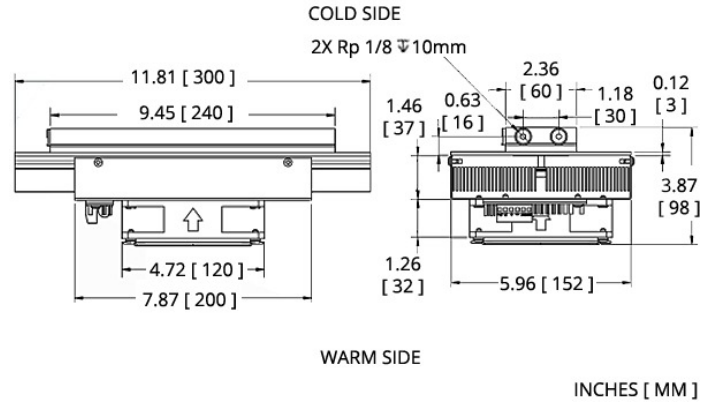

ELECTRICAL AND THERMAL PERFORMANCE

Heat Pumped at Cold Side (Q_c)
 Tambient = 35°C | Tcontrol = 20°C

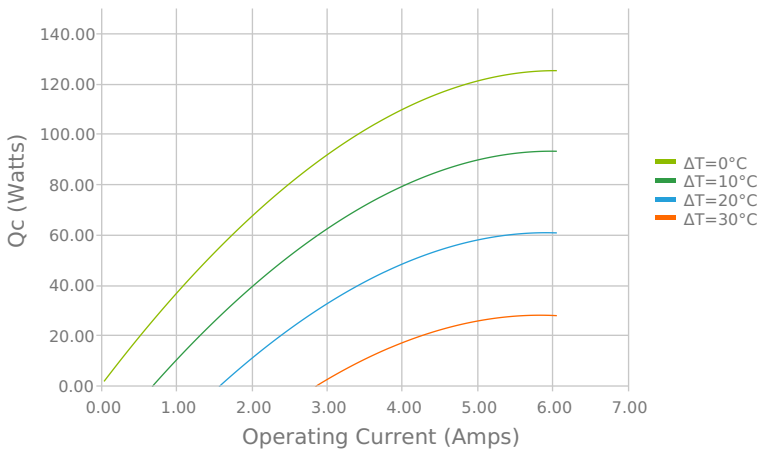

Heat Pumped at Cold Side (Q_c)
 Tambient = 35°C | Tcontrol = 20°C

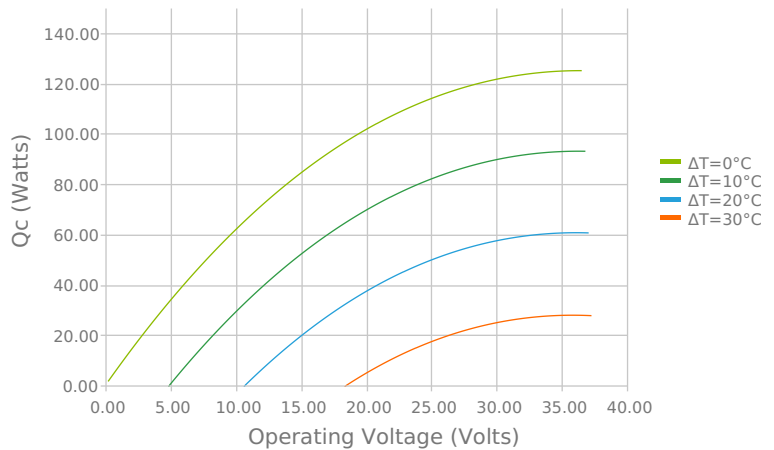

Coefficient of Performance (COP = Qc/Pin)
 Tambient = 35°C | Tcontrol = 20°C

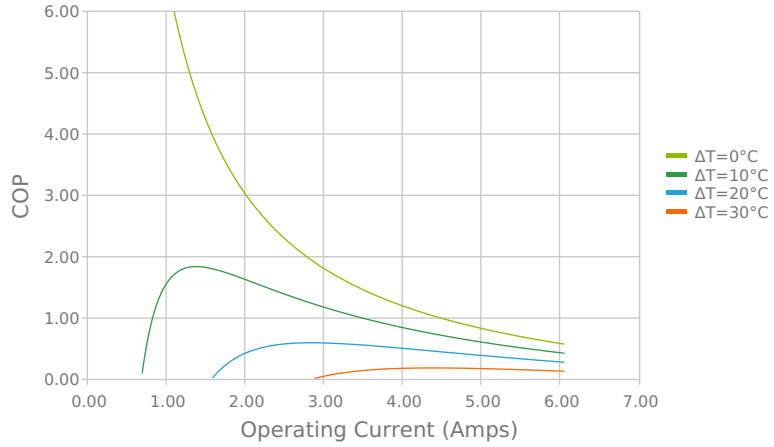

Coefficient of Performance (COP = Qc/Pin)
 Tambient = 35°C | Tcontrol = 20°C

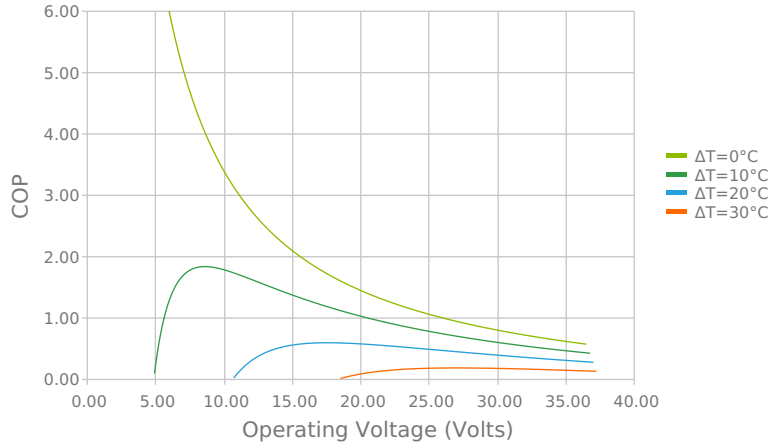

Total Heat Dissipated at Hot Side (Qh=Qc+Pin)
 Tambient = 35°C | Tcontrol = 20°C

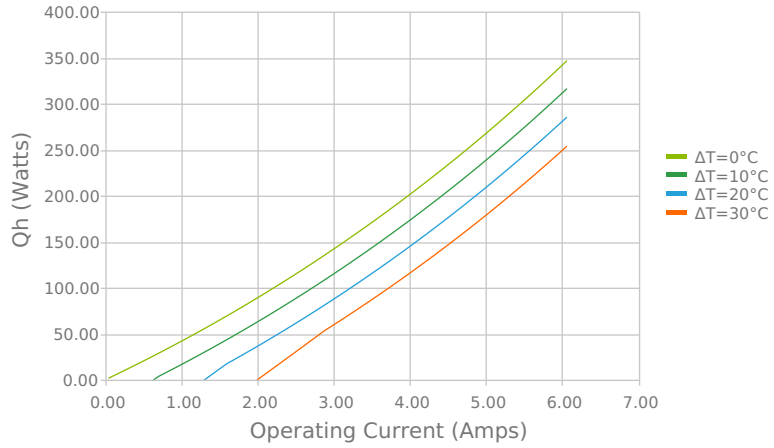

Total Heat Dissipated at Hot Side (Qh=Qc+Pin)
 Tambient = 35°C | Tcontrol = 20°C

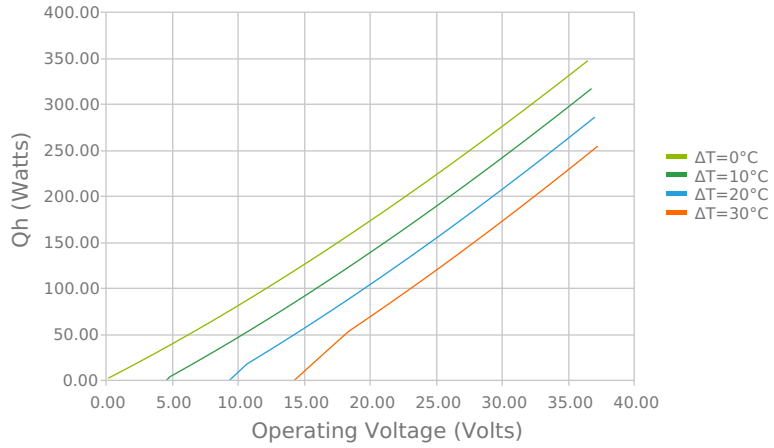

Heat Pumped at Cold Side (Qc)
 Voperating = 24.08 Volts | Ioperating = 4.18 Amps

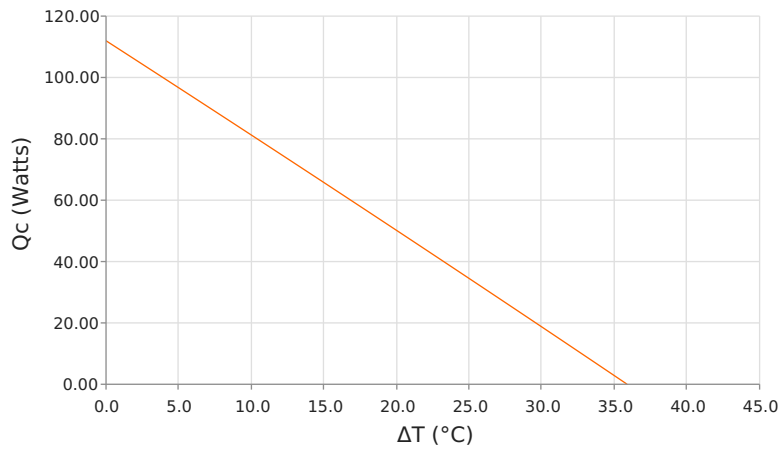

Coefficient of Performance (COP = Qc/Pin)
 Voperating = 24.08 Volts | Ioperating = 4.18 Amps

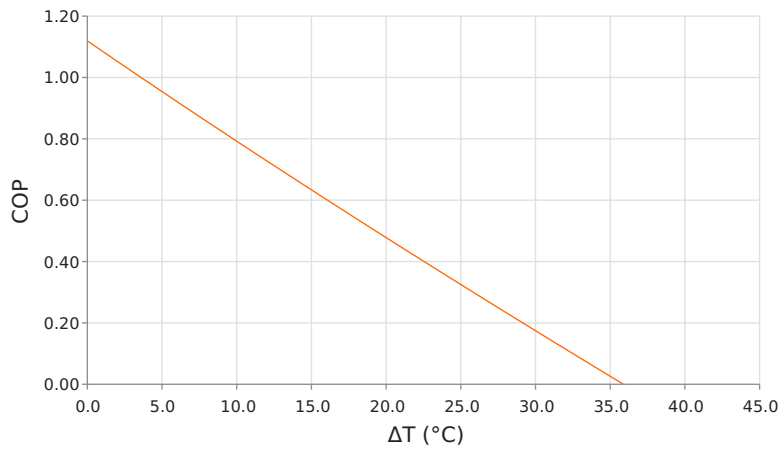

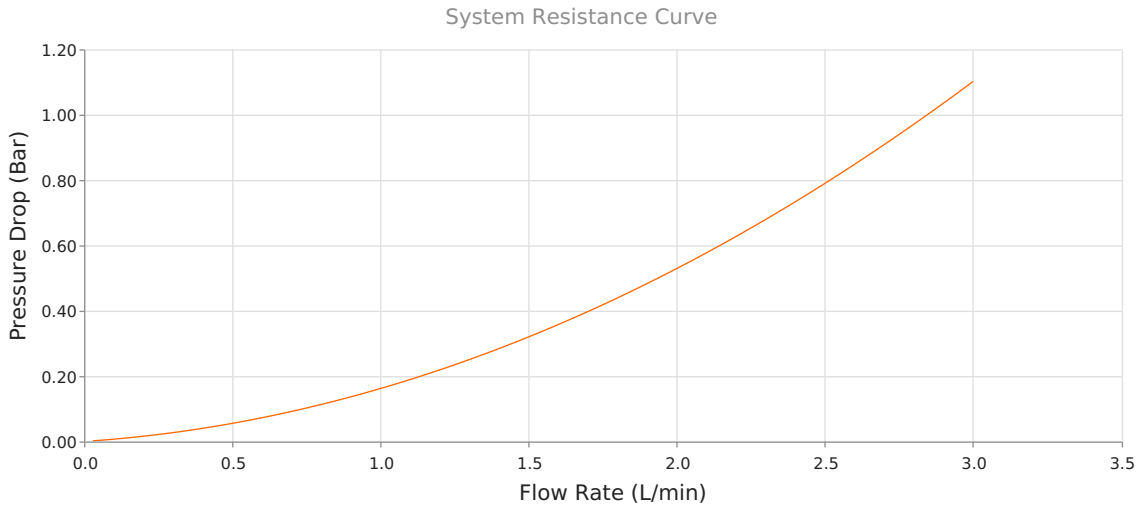

SPECIFICATIONS

Heat Transfer Mechanism, Cold Side

Heat Transfer Mechanism, Hot Side

Operating Temperature Range

Supply Voltage

Current Draw

Power Supply

Performance Tolerance

Hi-Pot Testing

Fan MTBF

Over-Temp Thermostat (Hot and Cold Side Heat Sink)

Weight

Panel Mounting

Liquid - Forced Convection
Air - Forced Convection
-10°C to 47°C
24.0 VDC nominal / 30.0 VDC maximum
5.3 A running / 6.6 A startup
139.0 Watts
10%
750 VDC
50,000 hours
75°C ±5°C (hot side heat sink)
3.20 kg
Flush Mount

MOUNTING HOLE LOCATION

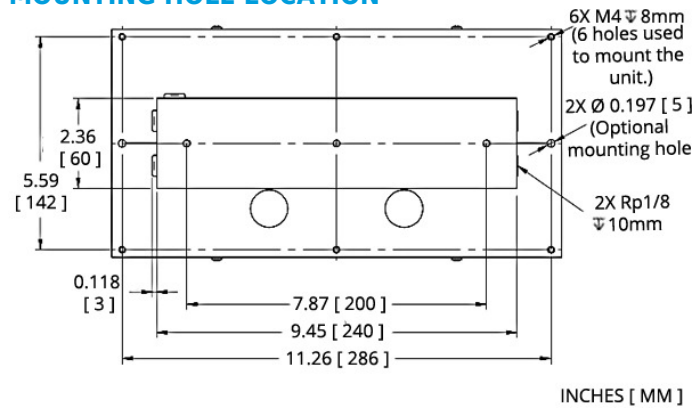

ELECTRICAL CONNECTIONS

- " + " : + TEM
- " - " : - TEM
- " F+ " : + FAN(S)
- " F- " : - FAN(S)

To use single supply:
Lift the jumpers and rotate 90° to short-out the pin pairs.
Connect the unit to " + " & " - ".

Warning: Single supply not applicable in heating mode or with PWM-regulation.

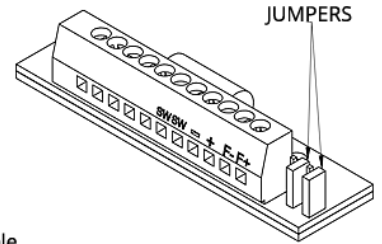

NOTES

- ¹For indoor use only
- ²Turbulators are mounted inside liquid channels to create turbulent flow
- ³Cold block requires insulation to minimize moisture buildup under dew point conditions.

Any information furnished by Laird and its agents, whether in specifications, data sheets, product catalogues or otherwise, is believed to be (but is not warranted as being) accurate and reliable, is provided for information only and does not form part of any contract with Laird. All specifications are subject to change without notice. Laird assumes no responsibility and disclaims all liability for losses or damages resulting from use of or reliance on this information. All Laird products are sold subject to the Laird Terms and Conditions of sale (including Laird's limited warranty) in effect from time to time, a copy of which will be furnished upon request.

© Copyright 2019-2022 Laird Thermal Systems, Inc. All rights reserved. Laird™, the Laird Ring Logo, and Laird Thermal Systems™ are trademarks or registered trademarks of Laird Limited or its subsidiaries.

Revision: 00 Date: 06-01-2022

Print Date: 06-15-2022