

|                          |   |   |     |       |             |
|--------------------------|---|---|-----|-------|-------------|
| 6                        | 5 | 4 | 3   | 2     | 1           |
| APPROVED: _____          |   |   | Rev | AWO # | Description |
| DATE: _____ TITLE: _____ |   |   | -   |       | RELEASED    |
|                          |   |   |     |       | Date        |
|                          |   |   |     |       | 2/18/21     |
|                          |   |   |     |       | Appr        |

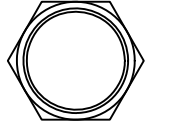

HEX NUT

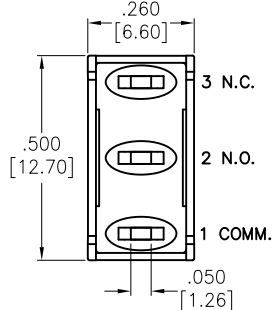
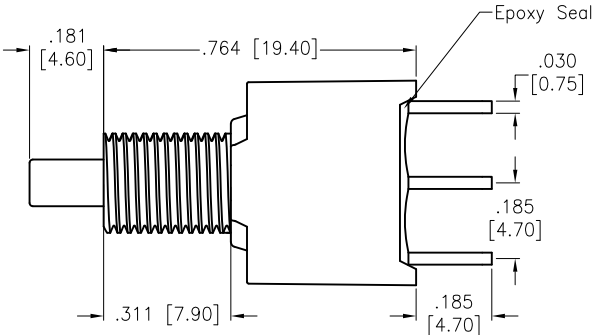
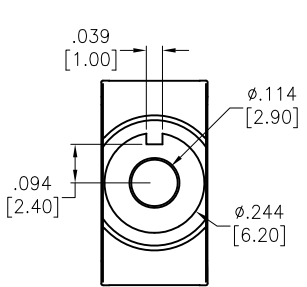
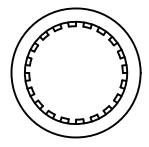

LOCK WASHER

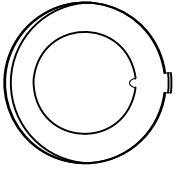

ANTI ROTATIONAL WASHER

INCLUDED HARDWARE

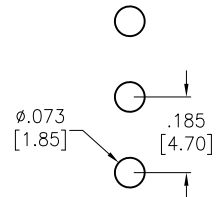
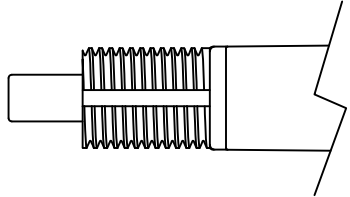

RECOMMENDED PCB LAYOUT

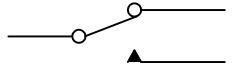

CIRCUIT DIAGRAM (SPDT) MOMENTARY

SPECIFICATIONS:

Material:  
 Movable Contact: Copper Alloy, Silver Plated  
 Terminal: Copper Alloy, Silver Plated With outer layer in Gold Plating  
 Electrical:  
 Voltage rating: 120VAC or 38VDC  
 Current rating: 1 Amps  
 Contact resistance: 10 mΩ max  
 Insulation resistance: 1,000 Mohms min  
 Dielectric withstanding voltage: 1,500V RMS @Sea level  
 Mechanical:  
 Waterproof: IP68  
 Temperature Rating:  
 Operating temperature: -30°C to +85°C  
 Environmental:  
 Lead free, RoHS compliant



|   |              |         |
|---|--------------|---------|
| UNLESS OTHERWISE SPECIFIED<br>ALL DIMENSIONS ARE INCHES [MM]<br>TOLERANCES: EXCEPT AS NOTED |              |         |
| INCHES  |              | HOLES   |
| .X ± .10  | Ø.X ± .10    |         |
| .XX ± .020  | Ø.XX ± .015  |         |
| .XXX ± .015   | Ø.XXX ± .010 |         |
| APPROVALS   |              | DATE    |
| DRAWN   | LH           | 2/18/21 |
| CHECKED   | AC           | 2/18/21 |
| APPROVED  |              |         |

**ADAM TECH** 909 Rahway Avenue,  
 Union, NJ 07083  
 Phone: 908-687-5000  
 Fax: 908-687-5710

TITLE: PUSHBUTTON SWITCH, IP68, PCB TYPE  
 SPDT, ON-MOMENTARY, GOLD OVER SILVER PLATED

|              |                               |              |
|--------------|-------------------------------|--------------|
| SIZE<br>X    | PART NO.<br>SW-PB8-AA00A2GE-2 | REV.<br>-    |
| REF: S00198T | SCALE: NTS                    | SHEET 1 OF 1 |