

FEATURES

Dual output frequency range

 $f_{OUT} = 12.47 \text{ GHz to } 13.72 \text{ GHz}$
 $f_{OUT/2} = 6.235 \text{ GHz to } 6.86 \text{ GHz}$

Output power (P_{OUT}): 10 dBm

Single-sideband (SSB) phase noise: -113 dBc/Hz at 100 kHz

No external resonator needed

RoHS compliant, 5 mm × 5 mm, 32-lead LFCSP: 25 mm²

APPLICATIONS

Point to point and multipoint radios

Test equipment and industrial controls

Very small aperture terminals (VSATs)

GENERAL DESCRIPTION

The [HMC1168](#) is a monolithic microwave integrated circuit (MMIC), voltage controlled oscillator (VCO) that integrates a resonator, a negative resistance device, and a varactor diode, and features a half frequency output.

FUNCTIONAL BLOCK DIAGRAM

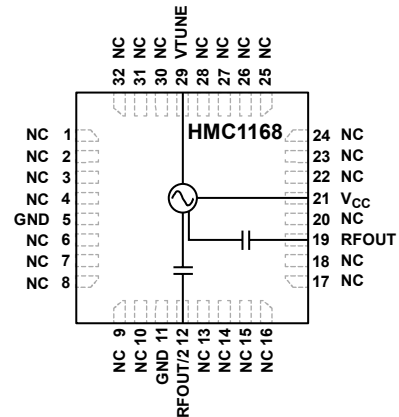

Figure 1.

Because of the monolithic construction of the oscillator, the output power and phase noise performance are excellent over temperature.

The output power is 10 dBm typical from a 5 V supply voltage. The VCO is housed in a RoHS compliant LFCSP and requires no external matching components.

TABLE OF CONTENTS

| | | | |
|--|---|---|----|
| Features | 1 | Typical Performance Characteristics | 7 |
| Applications..... | 1 | Theory of Operation | 9 |
| Functional Block Diagram | 1 | Applications Information | 10 |
| General Description | 1 | Evaluation Printed Circuit Board (PCB)..... | 11 |
| Revision History | 2 | Bill of Materials..... | 11 |
| Specifications..... | 3 | Packaging and Ordering Information | 12 |
| Absolute Maximum Ratings..... | 4 | Outline Dimensions..... | 12 |
| ESD Caution..... | 4 | Ordering Guide | 12 |
| Pin Configuration and Function Descriptions..... | 5 | | |
| Interface Schematics..... | 6 | | |

REVISION HISTORY

12/2017—Rev. 0 to Rev. A

| | |
|---------------------------------|----|
| Changes to Figure 15..... | 8 |
| Updated Outline Dimensions..... | 12 |
| Changes to Ordering Guide | 12 |

1/2016—Revision 0: Initial Version

SPECIFICATIONS

$T_A = -40^{\circ}\text{C}$ to $+85^{\circ}\text{C}$, $V_{CC} = 5\text{ V}$, unless otherwise noted.

Table 1.

| Parameter | Min | Typ | Max | Unit | Test Conditions/Comments |
|--|-------|------|-------|-------------------------|---|
| FREQUENCY | | | | | |
| Range | | | | | |
| Output Frequency (f_{OUT}) | 12.47 | | 13.72 | GHz | |
| Half Output Frequency ($f_{OUT}/2$) | 6.235 | | 6.86 | GHz | |
| Drift Rate | | 1.2 | | MHz/ $^{\circ}\text{C}$ | |
| Pulling | | 2 | | MHz p-p | Pulling into a 2.0:1 voltage standing wave ratio (VSWR) |
| Pushing | | 2 | | MHz/V | At VTUNE = 5 V |
| OUTPUT POWER (P_{OUT}) | | | | | |
| RFOUT | 7 | 10 | 14 | dBm | |
| RFOUT/2 | -1 | +2 | +6 | dBm | |
| Supply Current (I_{CC}) | | 170 | | mA | $V_{CC} = 4.75\text{ V}$ |
| | | 190 | 240 | mA | $V_{CC} = 5.00\text{ V}$ |
| | | 210 | | mA | $V_{CC} = 5.25\text{ V}$ |
| HARMONICS, SUBHARMONICS | | | | | |
| 1/2 | | 42 | | dBc | |
| 3/2 | | 34 | | dBc | |
| Second | | 17 | | dBc | |
| Third | | 28 | | dBc | |
| TUNING | | | | | |
| Voltage (VTUNE) | 2 | | 13 | V | |
| Sensitivity | 75 | | 350 | MHz/V | |
| Tune Port Leakage Current | | | 10 | μA | VTUNE = 13 V |
| OUTPUT RETURN LOSS | | | | | |
| | | 5 | | dB | |
| SSB PHASE NOISE | | | | | |
| 10 kHz Offset | | -85 | -82 | dBc/Hz | |
| 100 kHz Offset | | -113 | -110 | dBc/Hz | |

ABSOLUTE MAXIMUM RATINGS

Table 2.

| Parameter | Rating |
|--|------------------|
| V _{CC} | 5.5 V dc |
| VTUNE | 0 V to 15 V |
| Operating Temperature Range | −40°C to +85°C |
| Storage Temperature Range | −65°C to +150°C |
| Nominal Junction Temperature (to Maintain 1 Million Hours Mean Time to Failure (MTTF)) | 135°C |
| Nominal Junction Temperature (T _A = 85°C) | 119°C |
| Maximum Reflow Temperature (MSL3 Rating) | 260°C |
| Thermal Resistance (Junction to Ground Pad) | 29°C/W |
| ESD Sensitivity | |
| Human Body Model (HBM) | 300 V (Class 1A) |
| Field Induced Charged Device Model (FICDM) | 300 V (Class II) |

Stresses at or above those listed under Absolute Maximum Ratings may cause permanent damage to the product. This is a stress rating only; functional operation of the product at these or any other conditions above those indicated in the operational section of this specification is not implied. Operation beyond the maximum operating conditions for extended periods may affect product reliability.

ESD CAUTION



ESD (electrostatic discharge) sensitive device. Charged devices and circuit boards can discharge without detection. Although this product features patented or proprietary protection circuitry, damage may occur on devices subjected to high energy ESD. Therefore, proper ESD precautions should be taken to avoid performance degradation or loss of functionality.

PIN CONFIGURATION AND FUNCTION DESCRIPTIONS

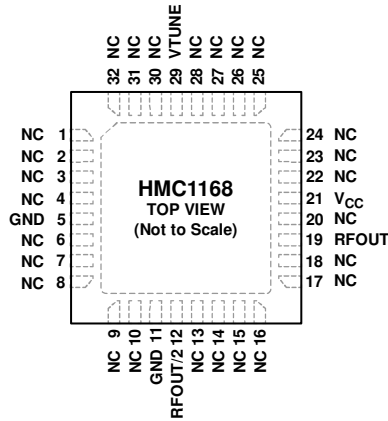

- NOTES**
1. NC = NO CONNECT. HOWEVER, THESE PINS CAN BE CONNECTED TO RF/DC GROUND WITHOUT AFFECTING THE PERFORMANCE OF THE DEVICE.
 2. EXPOSED PAD. THE PACKAGE BOTTOM HAS AN EXPOSED METAL PAD THAT MUST BE CONNECTED TO RF/DC GROUND.

13945-002

Figure 2. Pin Configuration

Table 3. Pin Function Descriptions

| Pin No. | Mnemonic | Description |
|---|-----------------|---|
| 1 to 4, 6 to 10, 13 to 18, 20, 22 to 28, 30 to 32 | NC | No Connect. However, these pins can be connected to RF/dc ground without affecting the performance of the device. |
| 5, 11 | GND | Ground. These pins must be connected to RF/dc ground. |
| 12 | RFOUT/2 | Half Radio Frequency Output. This pin is ac-coupled. |
| 19 | RFOUT | Radio Frequency Output. This pin is ac-coupled. |
| 21 | V _{CC} | Supply Voltage (5 V). |
| 29 | VTUNE | Control Voltage and Modulation Input. The modulation bandwidth is dependent on the drive source impedance. |
| | EP | Exposed Pad. The package bottom has an exposed metal pad that must be connected to RF/dc ground. |

INTERFACE SCHEMATICS

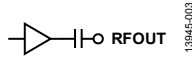

Figure 3. RFOUT Interface

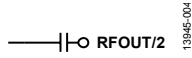

Figure 4. RFOUT/2 Interface

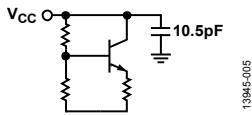

Figure 5. Vcc Interface

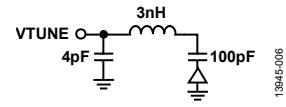

Figure 6. VTUNE Interface



Figure 7. GND Interface

TYPICAL PERFORMANCE CHARACTERISTICS

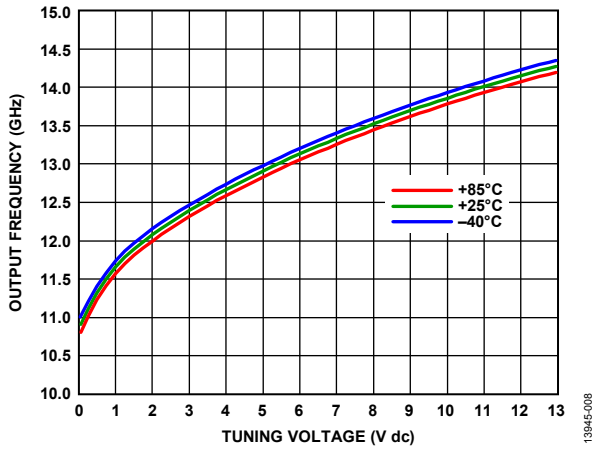

Figure 8. Output Frequency vs. Tuning Voltage

13945-008

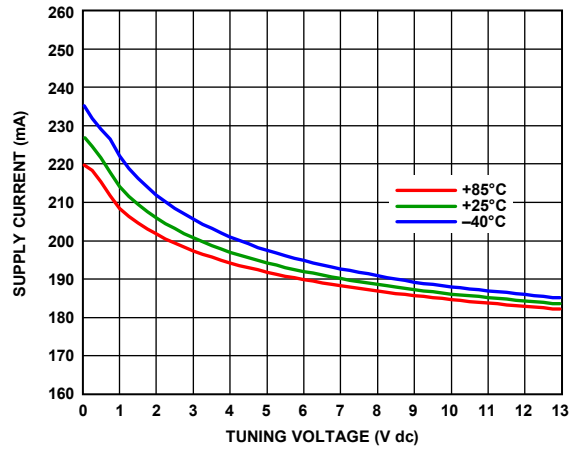

Figure 11. Supply Current (I_{cc}) vs. Tuning Voltage

13945-011

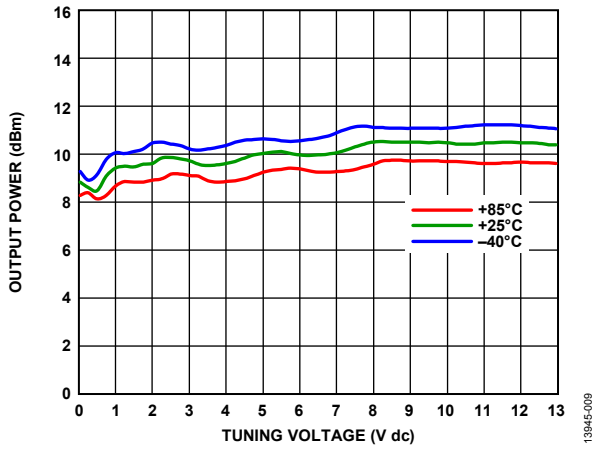

Figure 9. Output Power vs. Tuning Voltage

13945-009

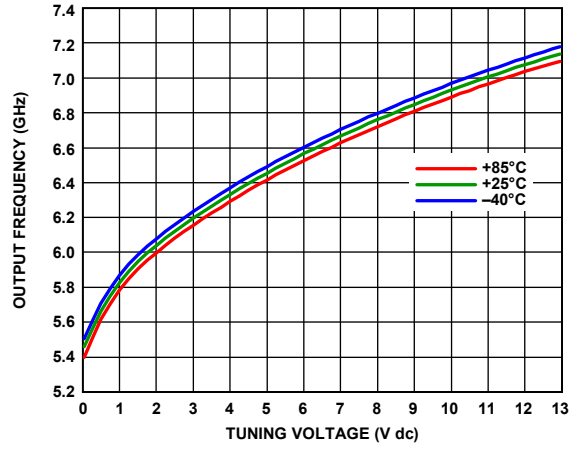

Figure 12. RFOUT/2 Output Frequency vs. Tuning Voltage

13945-012

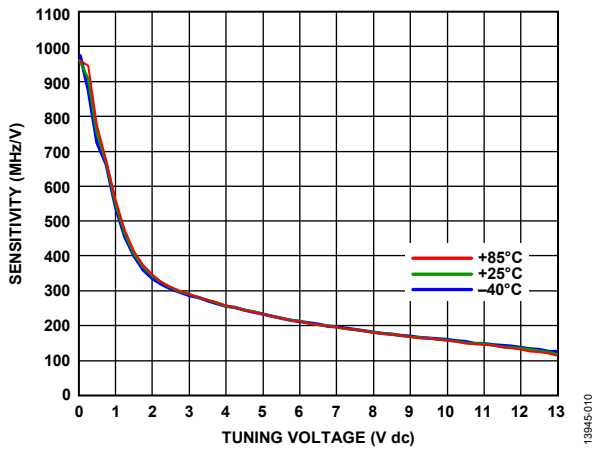

Figure 10. Sensitivity vs. Tuning Voltage

13945-010

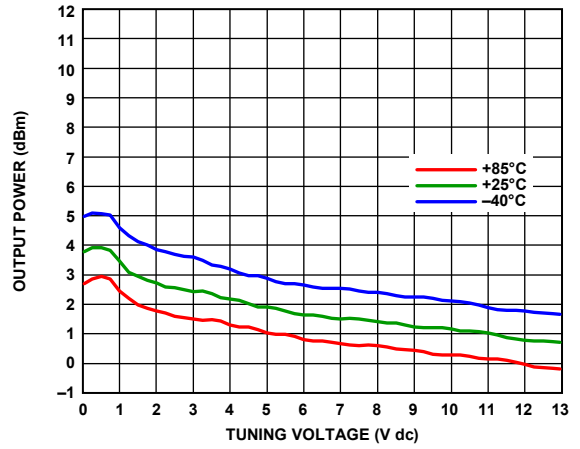

Figure 13. RFOUT/2 Output Power vs. Tuning Voltage

13945-013

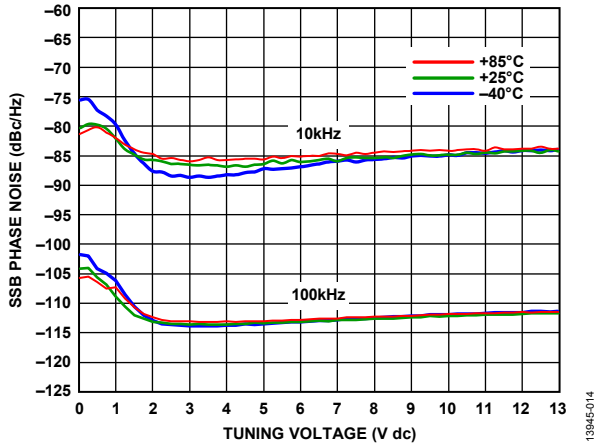

Figure 14. SSB Phase Noise vs. Tuning Voltage

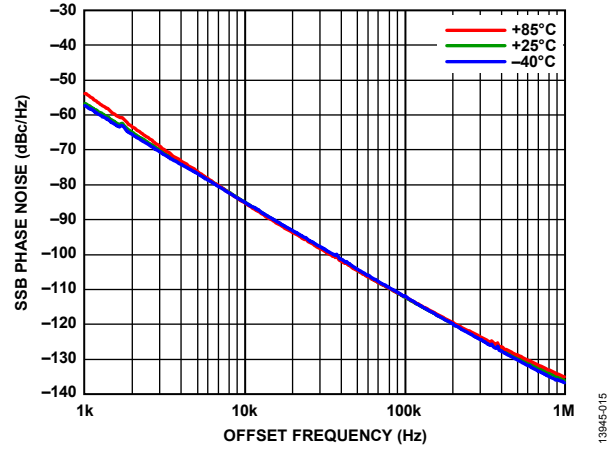

Figure 15. SSB Phase Noise vs. Offset Frequency at VTUNE = 5 V

THEORY OF OPERATION

The HMC1168 voltage controlled oscillator is a free running voltage controlled frequency source. The output frequency is controlled by applying a variable tune voltage to the VTUNE port. Because VTUNE is varied from the lowest to the highest allowed voltage, the VCO output frequency increases from the lowest to the highest operating frequency. This VCO output frequency change with the applied VTUNE input results in the VCO frequency sensitivity characteristic (MHz/V). The VCO frequency sensitivity is not constant and varies across the tunable range.

The HMC1168 VCO is specified to cover the minimum to maximum frequencies specified in this data sheet over the entire specified temperature range, including the VCO frequency drift (MHz/°C). In addition, for low phase noise operation, drive the VTUNE port from a low noise voltage source. Excessive noise on the VTUNE port results in poor phase noise performance. The tune port modulation bandwidth is typically greater than 10 MHz.

To achieve optimum VCO phase noise performance when using the HMC1168, it is important to use a low noise power supply for V_{CC} biasing. Because the VCO output frequency changes with small changes in the V_{CC} bias voltage (pushing), noise on the V_{CC} bias pin results in increased phase noise. Take care to use low noise regulators, otherwise, bias line noise may corrupt the low phase noise output of the HMC1168.

Internally, the radio frequency (RF) output frequency is generated from a doubler circuit. This generation results in an unwanted low level output signal present at half the RFOUT frequency (RFOUT/2). If necessary, this undesired spurious signal can be further filtered on the customer application board using a filter. The RFOUT/2 output signal is available directly at the RFOUT/2 port. The RFOUT/2 port commonly drives a phase-locked loop (PLL)/synthesizer for phase locking the HMC1168 output if needed.

Lastly, the HMC1168 RFOUT port incorporates an internal buffer amplifier to provide good output matching. The internal buffer amplifier also isolates the VCO core from the output load and minimizes the VCO frequency change with the changes to the output load impedance (pulling).

APPLICATIONS INFORMATION

The HMC1168 serves as the local oscillator (LO) in microwave synthesizer applications. The primary applications are point to point microwave radios, military, radars, test and measurement, as well as industrial and medical equipment. The low phase noise allows higher orders of modulation and offers improved bit error rates in communication systems, whereas the linear,

monotonic tuning sensitivity allows a stable loop filter design. The higher output power minimizes the gain required to drive subsequent stages. The half frequency output reduces the input frequency to the prescaler without the addition of residual phase noise to the input of the phase-locked loop synthesizer.

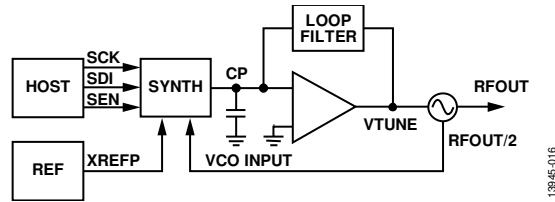

Figure 16. Typical Application Diagram

13846-016

EVALUATION PRINTED CIRCUIT BOARD (PCB)

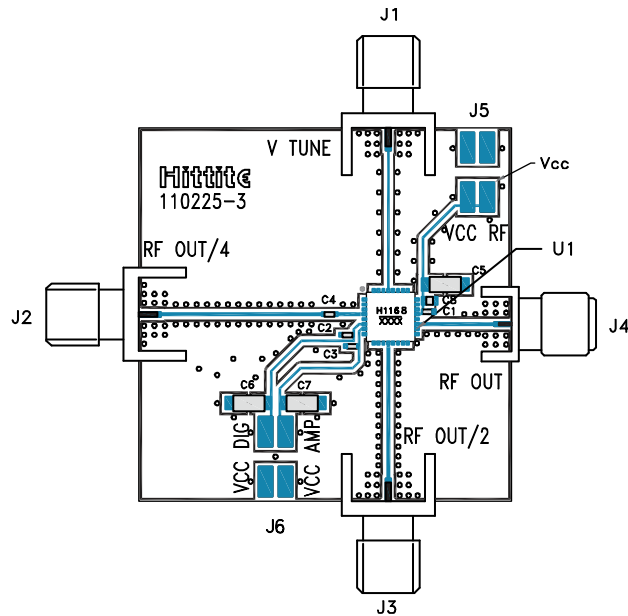

Figure 17. Evaluation PCB

The circuit board used in an application uses RF circuit design techniques. Ensure that the signal lines have $50\ \Omega$ impedance and that the package ground leads and backside ground paddle are connected directly to the ground plane.

Use a sufficient number of via holes to connect the top and bottom ground planes. The evaluation circuit board shown in Figure 17 is available from Analog Devices, Inc., upon request.

BILL OF MATERIALS

Table 4. Bill of Materials for the [EV1HMC1168LP5](#)

| Item | Description |
|------------------|--------------------------------------|
| J1 to J4 | PCB mount SMA RF connectors |
| J5, J6 | 2 mm dc headers |
| C1 to C3 | 100 pF capacitors, 0402 package |
| C4 | 1000 pF capacitor, 0402 package |
| C5 to C7 | 2.2 μ F tantalum capacitors |
| C8 | 0.01 μ F capacitor, 0603 package |
| U1 | HMC1168 VCO |
| PCB ¹ | 110225 evaluation board ² |

¹ Circuit board material is Rogers 4350.

² Reference this number when ordering the complete evaluation PCB.

PACKAGING AND ORDERING INFORMATION

OUTLINE DIMENSIONS

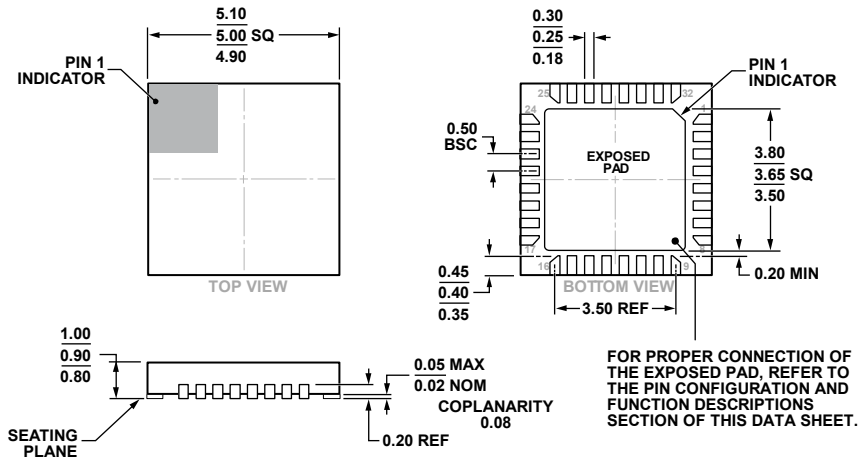

COMPLIANT TO JEDEC STANDARDS MO-220-VHHD-4.

Figure 18. 32-Lead Lead Frame Chip Scale Package [LFCSP]
 5 mm × 5 mm Body and 0.85 mm Package Height
 (HCP-32-1)
 Dimensions shown in millimeters

ORDERING GUIDE

| Model ¹ | Temperature Range | MSL Rating ² | Package Description | Package Option | Qty. |
|--------------------|-------------------|-------------------------|---------------------------------|----------------|------|
| HMC1168LP5E | -40°C to +85°C | MSL3 | 32-Lead LFCSP | HCP-32-1 | |
| HMC1168LP5ETR | -40°C to +85°C | MSL3 | 32-Lead LFCSP, 7" Tape and Reel | HCP-32-1 | 500 |
| EV1HMC1168LP5 | | | Evaluation Board | | |

¹ All models are RoHS compliant.

² See the Absolute Maximum Ratings section, Table 2.