

2SC5994

Bipolar Transistor 50V, 2A, Low VCE(sat), NPN Single



ON Semiconductor®

www.onsemi.com

Features

- Adoption of MBIT Process
- Low Collector to Emitter Saturation Voltage
- Large Current Capacity
- High Speed Switching

Typical Applications

- Voltage Regulators
- Relay Drivers
- Lamp Drivers
- Electrical Equipment

SPECIFICATIONS

ABSOLUTE MAXIMUM RATING at Ta = 25°C (Note 1, 2)

Parameter	Symbol	Value	Unit
Collector to Base Voltage	VCBO	100	V
Collector to Emitter Voltage	VCES	100	V
	VCEO	50	V
Emitter to Base Voltage	VEBO	6	V
Collector Current	IC	2	A
Collector Current (Pulse)	ICP	4	A
Base Current	IB	400	mA
Collector Dissipation	(Note 2)	1.3	W
	Tc=25°C	3.5	W
Junction Temperature	Tj	150	°C
Storage Temperature	Tstg	-55 to +150	°C

Note 1 : Stresses exceeding those listed in the Maximum Ratings table may damage the device. If any of these limits are exceeded, device functionality should not be assumed, damage may occur and reliability may be affected.

Note 2 : Surface mounted on ceramic substrate(450mm² × 0.8mm)

ELECTRICAL CONNECTION

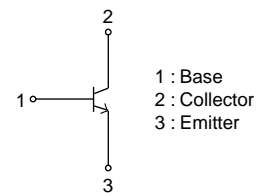

MARKING

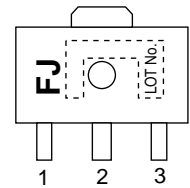
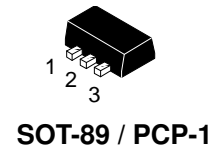

ORDERING INFORMATION

See detailed ordering and shipping information on page 5 of this data sheet.

2SC5994

ELECTRICAL CHARACTERISTICS at Ta = 25°C (Note 3)

Parameter	Symbol	Conditions	Value			Unit
			min	typ	max	
Collector Cutoff Current	ICBO	V _{CB} =50V, I _E =0A			1	μA
Emitter Cutoff Current	IEBO	V _{EB} =4V, I _C =0A			1	μA
DC Current Gain	hFE1	V _{CE} =2V, I _C =100mA	200		560	
	hFE2	V _{CE} =2V, I _C =1.5A	40			
Gain-Bandwidth Product	f _T	V _{CE} =10V, I _C =300mA		420		MHz
Output Capacitance	C _{ob}	V _{CB} =10V, f=1MHz		9		pF
Collector to Emitter Saturation Voltage	V _{CE(sat)}	I _C =1A, I _B =50mA		135	300	mV
Base to Emitter Saturation Voltage	V _{BE(sat)}	I _C =1A, I _B =50mA		0.9	1.2	V
Collector to Base Breakdown Voltage	V _{(BR)CBO}	I _C =10μA, I _E =0A	100			V
Collector to Emitter Breakdown Voltage	V _{(BR)CES}	I _C =100μA, R _{BE} =0Ω	100			V
	V _{(BR)CEO}	I _C =1mA, R _{BE} =∞	50			V
Emitter to Base Breakdown Voltage	V _{(BR)EBO}	I _E =10μA, I _C =0A	6			V
Turn-On Time	t _{on}	See specified Test Circuit		30		ns
Storage Time	t _{stg}			330		ns
Fall Time	t _f			40		ns

Note 3 : Product parametric performance is indicated in the Electrical Characteristics for the listed test conditions, unless otherwise noted. Product performance may not be indicated by the Electrical Characteristics if operated under different conditions.

Switching Time Test Circuit

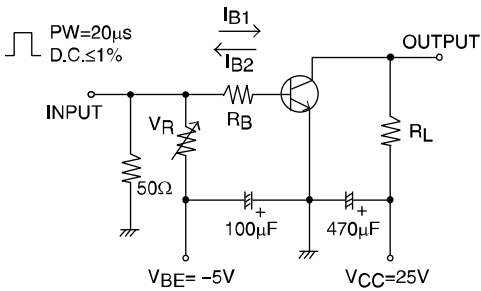

$$I_C = 10I_{B1} = -10I_{B2} = 700\text{mA}$$

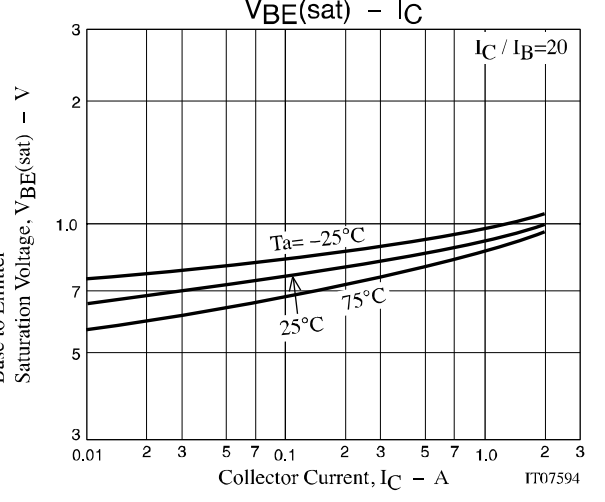
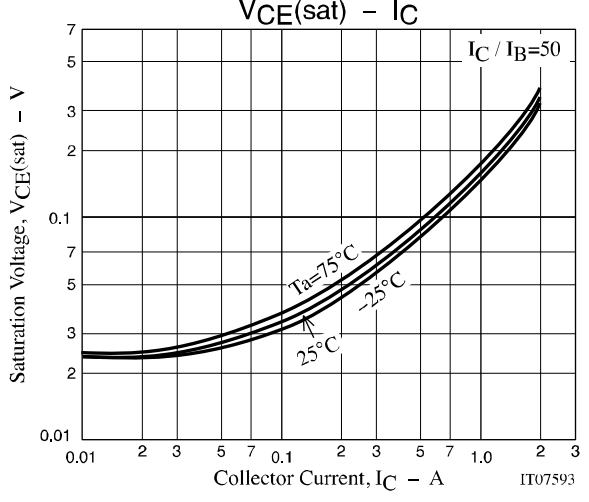
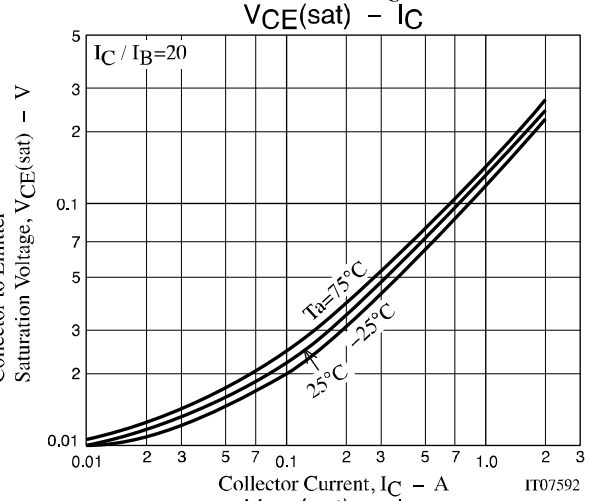
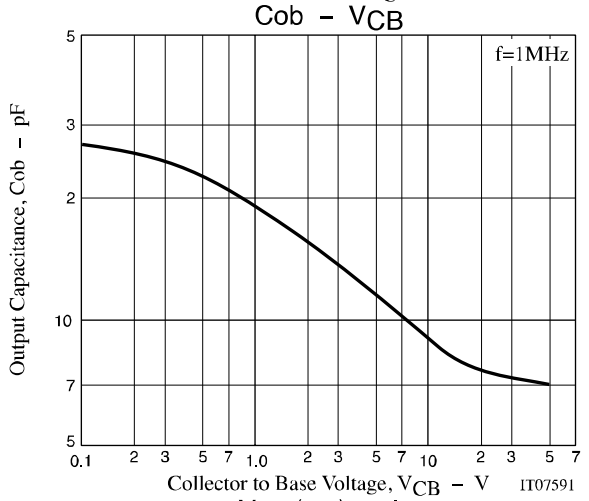
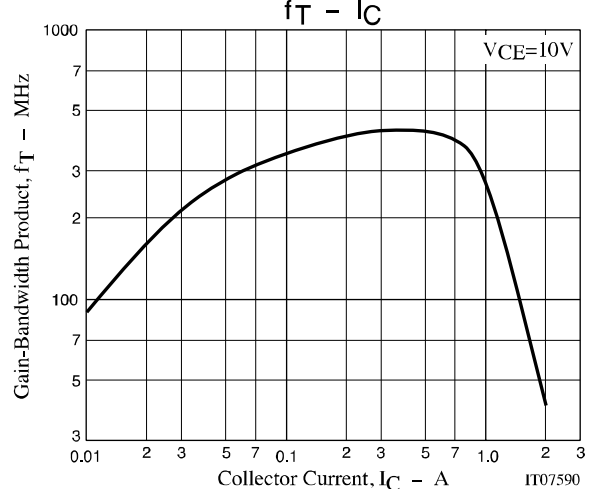
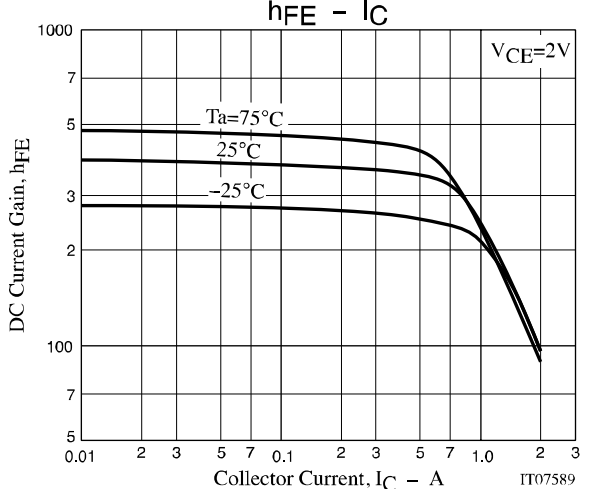
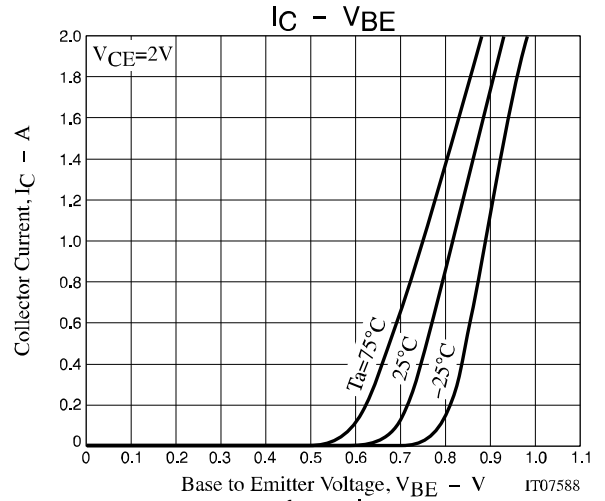
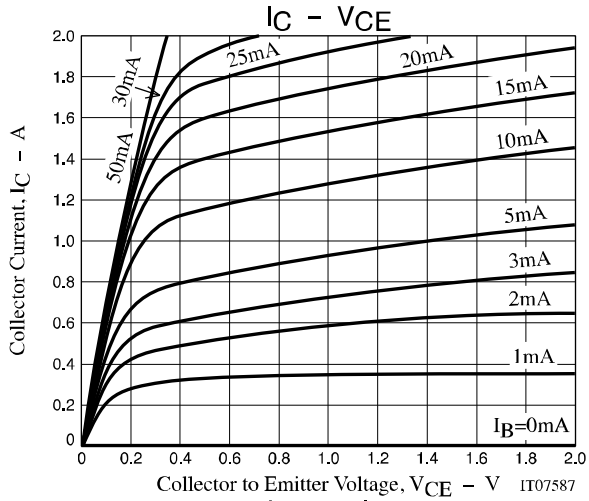

2SC5994

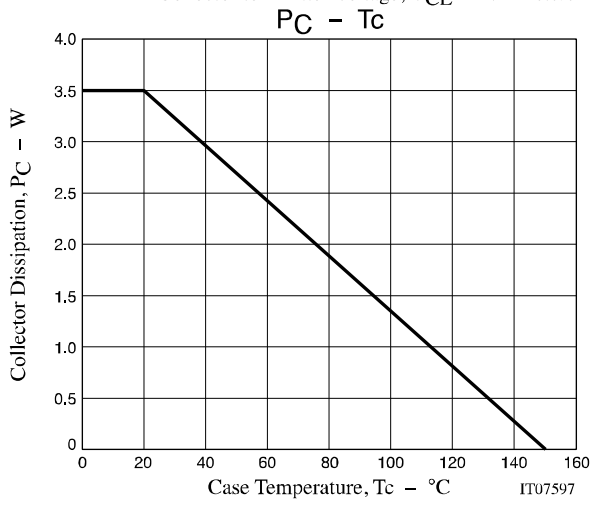
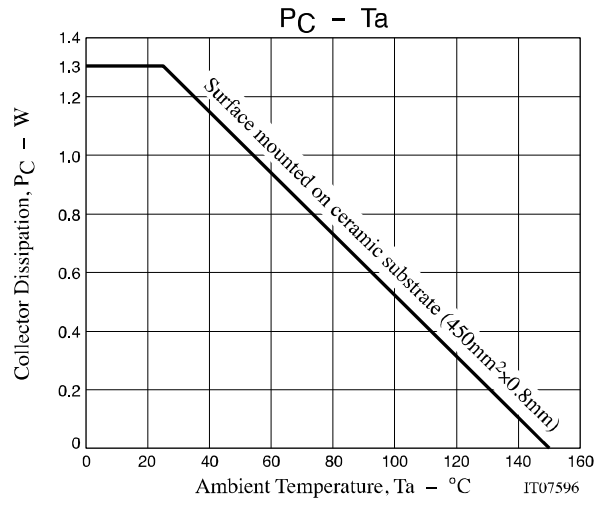
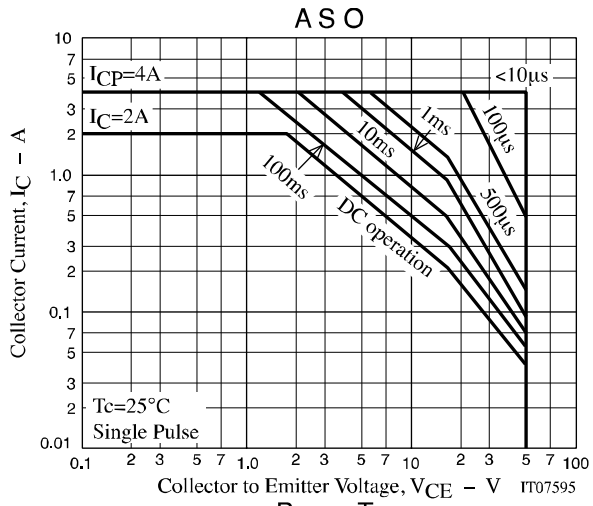

2SC5994

PACKAGE DIMENSIONS

unit : mm

SOT-89 / PCP-1

CASE 419AU

ISSUE 0

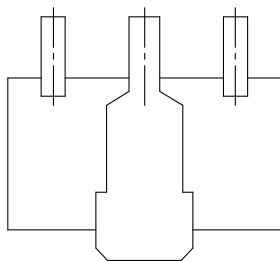
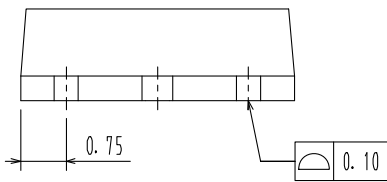
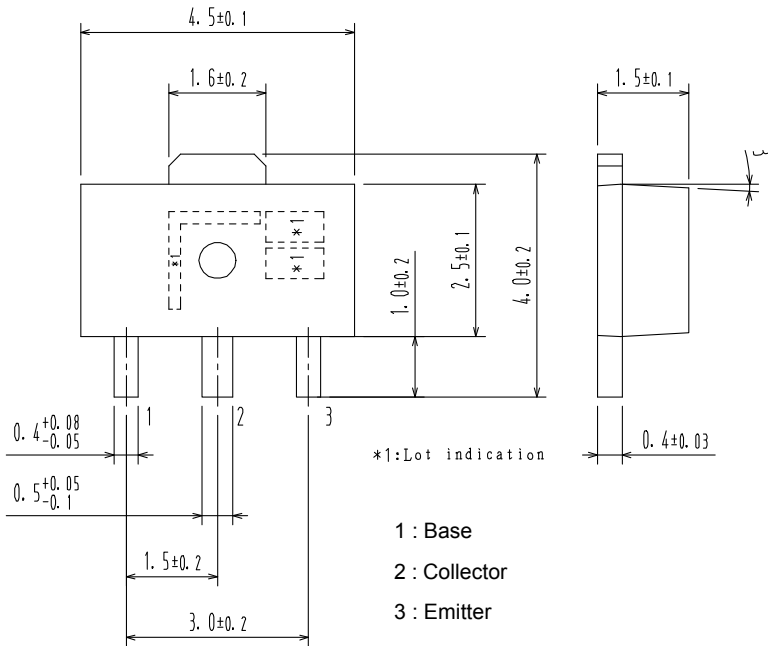

Recommended Soldering Footprint

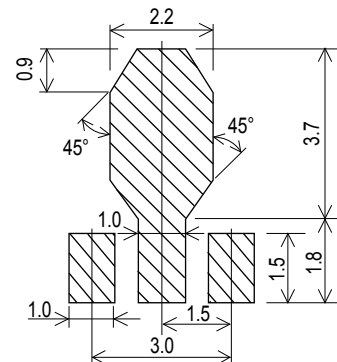

ORDERING INFORMATION

Device	Marking	Package	Shipping (Qty / Packing)
2SC5994-TD-E	FJ	SOT-89 / PCP-1 (Pb-Free)	1,000 / Tape & Reel

† For information on tape and reel specifications, including part orientation and tape sizes, please refer to our Tape and Reel Packaging Specifications Brochure, BRD8011/D. http://www.onsemi.com/pub_link/Collateral/BRD8011-D.PDF

ON Semiconductor and the ON logo are registered trademarks of Semiconductor Components Industries, LLC (SCILLC) or its subsidiaries in the United States and/or other countries. SCILLC owns the rights to a number of patents, trademarks, copyrights, trade secrets, and other intellectual property. A listing of SCILLC's product/patent coverage may be accessed at www.onsemi.com/site/pdf/Patent-Marking.pdf. SCILLC reserves the right to make changes without further notice to any products herein. SCILLC makes no warranty, representation or guarantee regarding the suitability of its products for any particular purpose, nor does SCILLC assume any liability arising out of the application or use of any product or circuit, and specifically disclaims any and all liability, including without limitation special, consequential or incidental damages. "Typical" parameters which may be provided in SCILLC data sheets and/or specifications can and do vary in different applications and actual performance may vary over time. All operating parameters, including "Typicals" must be validated for each customer application by customer's technical experts. SCILLC does not convey any license under its patent rights nor the rights of others. SCILLC products are not designed, intended, or authorized for use as components in systems intended for surgical implant into the body, or other applications intended to support or sustain life, or for any other application in which the failure of the SCILLC product could create a situation where personal injury or death may occur. Should Buyer purchase or use SCILLC products for any such unintended or unauthorized application, Buyer shall indemnify and hold SCILLC and its officers, employees, subsidiaries, affiliates, and distributors harmless against all claims, costs, damages, and expenses, and reasonable attorney fees arising out of, directly or indirectly, any claim of personal injury or death associated with such unintended or unauthorized use, even if such claim alleges that SCILLC was negligent regarding the design or manufacture of the part. SCILLC is an Equal Opportunity/Affirmative Action Employer. This literature is subject to all applicable copyright laws and is not for resale in any manner.