

XB5KS2B4

Harmony XB5, Illuminated buzzer, plastic, red, Ø22, continuous or intermittent tone, 24 V AC/DC



Main

Range of Product	Harmony XB5
Bezel material	Plastic
Product or Component Type	Annunciator
Mounting diameter	0.87 in (22 mm)
Cap/operator or lens colour	Red

Complementary

[Us] rated supply voltage	24 V +/- 10 %
Supply circuit type	AC/DC
Supply frequency	50/60 Hz
Current Consumption	<= 58 mA
Signalling type	Continuous or intermittent tone
Resistance to high pressure washer	1305.34 psi (9000000 Pa) 176 °F (80 °C) 0.1 m
Height	1.14 in (29 mm)
Width	1.14 in (29 mm)
Depth	2.17 in (55 mm)
Net Weight	0.05 lb(US) (0.024 kg)

Environment

Noise level	90 dB 0.1 m
Protective treatment	TH
Ambient Air Temperature for Storage	-40...158 °F (-40...70 °C)
Ambient air temperature for operation	-40...158 °F (-40...70 °C)
Overvoltage category	Class II IEC 60536
IP degree of protection	IP20 IEC 60529 rear face) IP66 IEC 60529 IP67 IP69 IP69K
NEMA degree of protection	NEMA 4X NEMA 13
IK degree of protection	IK05 EN 50102 IK03 IEC 50102

The information provided in this documentation contains general descriptions and/or technical characteristics of the performance of the products contained herein. This documentation is not intended as a substitute for and is not to be used for determining suitability or reliability of these products for specific user applications. It is the duty of any such user or integrator to perform the appropriate and complete risk analysis, evaluation and testing of the products with respect to the relevant specific application or use thereof. Neither Schneider Electric Industries SAS nor any of its affiliates or subsidiaries shall be responsible or liable for misuse of the information contained herein.

Standards	CSA C22.2 No 14 IEC 60947-5-1 EN 60947-5-4 JIS C8201-5-1 EN 60947-1 UL 508 IEC 60947-5-4 EN 60947-5-1 IEC 60947-1 JIS C8201-1
Product Certifications	UL Listed CSA BV





Ordering and shipping details

Category	00028 - DATA PORTS
Discount Schedule	CS2
GTIN	3606481352439
Nbr. of units in pkg.	1
Package weight(Lbs)	0.95 oz (27 g)
Returnability	Yes
Country of origin	ID

Packing Units

Unit Type of Package 1	PCE
Package 1 Height	1.30 in (3.3 cm)
Package 1 width	1.34 in (3.4 cm)
Package 1 Length	2.36 in (6 cm)
Unit Type of Package 2	S01
Number of Units in Package 2	88
Package 2 Weight	5.80 lb(US) (2.629 kg)
Package 2 Height	5.91 in (15 cm)
Package 2 width	5.91 in (15 cm)
Package 2 Length	15.75 in (40 cm)
Unit Type of Package 3	P06
Number of Units in Package 3	1408
Package 3 Weight	94.83 lb(US) (43.016 kg)
Package 3 Height	27.56 in (70 cm)
Package 3 width	31.50 in (80 cm)
Package 3 Length	23.62 in (60 cm)

Offer Sustainability

Sustainable offer status	Green Premium product
California proposition 65	WARNING: This product can expose you to chemicals including: Lead and lead compounds, which is known to the State of California to cause cancer and birth defects or other reproductive harm. For more information go to www.P65Warnings.ca.gov
REACH Regulation	 REACH Declaration
EU RoHS Directive	Pro-active compliance (Product out of EU RoHS legal scope)  EU RoHS Declaration
Mercury free	Yes
RoHS exemption information	 Yes
China RoHS Regulation	 China RoHS Declaration
Environmental Disclosure	 Product Environmental Profile
WEEE	The product must be disposed on European Union markets following specific waste collection and never end up in rubbish bins.

Dimensions

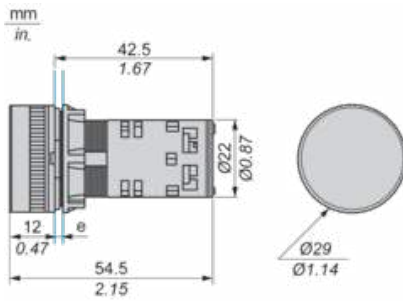

e: Clamping thickness: 1 to 6 mm / 0.04 to 0.24 in.

Panel Cut-out for Buzzer

Connection by Screw Clamp Terminals

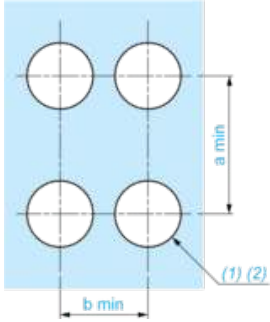

(1) Diameter on finished panel or support

(2) $\text{Ø}22.5 \text{ mm}$ recommended ($\text{Ø}22.3 \text{ }_0^{+0.4}$) / $\text{Ø}0.89 \text{ in.}$ recommended ($\text{Ø}0.88 \text{ in. }_0^{+0.016}$)

Connections	a in mm	a in in.	b in mm	b in in.
By screw clamp terminals or plug-in connector	40	1.57	30	1.18

Cabling of Annunciators

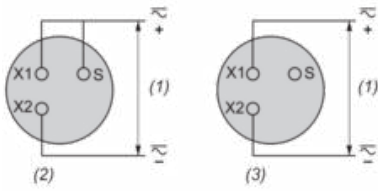

- (1) Supply
- (2) Intermittent
- (3) Continuous