



SPECIFICATIONS

Model	Stroke mm	Max Absorption Energy J(kgf·m)	Max Equivalent Mass kg (kgf)
FA-1210KB1-S	10	1.96(0.2)	15(15)

Max Drag N (kgf)	Absorption Energy per min. J/min(kgf·m/min)	Extension Force N(kgf)	Mass g
1470 (150)	98(10)	9.8(1.0) or lower	30.6

COMMON SPECIFICATIONS

Range of Impact Rate	m/s	0.3~1
Maximum Cycle Rate	cycle/min	60
Operating Temperature	C°	-5~70

PRECAUTIONS FOR USE

- Do not use this product without carefully reading the attached owner's manual.
- Ensure that an external stopper (Stopper nut OP-020SB) is also used.
- Do not turn the oil inlet screw located at the bottom of the main unit.
- Ensure that sufficient mounting strength is secured for this product. (As a guideline, it should be 2 to 3 times the maximum drag listed in the catalogue.)
- Do not use this product in a vacuum or a location where it may come in contact with oil.
- Ensure that an eccentric load is not applied to the soft absorber. (Allowable eccentric angle: within $\pm 2.5^\circ$)

OPTIONAL PARTS

Eccentric angle adaptor OP-010KB

- Screw the eccentric angle adaptor into the main unit until the cap for the eccentric angle and the piston rod form a tight connection. While maintaining this position, fasten the main unit's nut until it is secured.
- Use the eccentric angle adaptor when the eccentric angle is 2.5° or larger.
- The main unit can also be used as a stopper.
- Use it with a capless soft absorber.
- The maximum operating eccentric angle with an eccentric angle adaptor is $\pm 10^\circ$.
- The caps and the guides for inclined use are not unbundled.

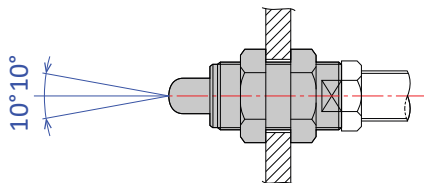
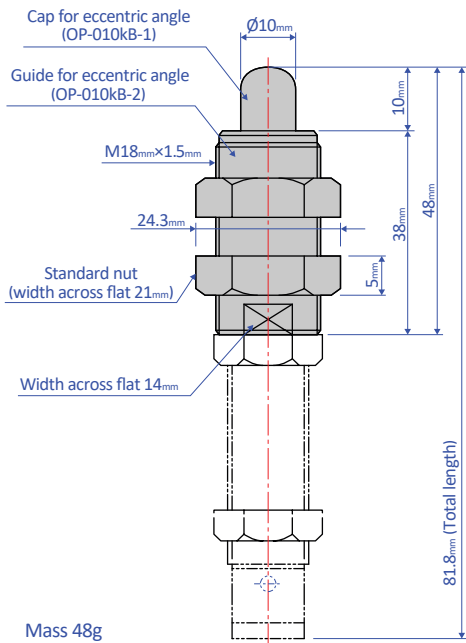

Note: Material of cap for eccentric angle: POM

Stopper nut OP-020KB

- Adjust so that it stops 1 mm before the stroke end, and fasten with the main unit's nut until secured.

OP-020KB-S (without cap)

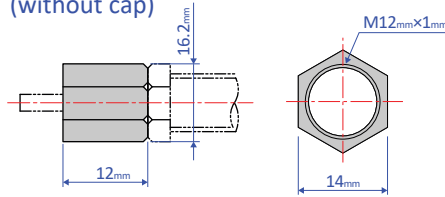

Mass 6g

OP-020KB-C (with cap)

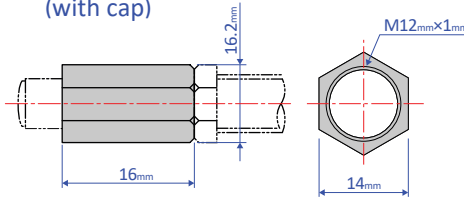

Mass 8g

Note: When attaching, make sure that the side without a bearing chamfer is the impact surface.

Standard nuts are sold separately as well - M12 Nut

Liquid-proof cap FA-1210KB1-C-060

- A drip-proof cap is fitted on the unit on delivery.
- Liquid-proof caps are not sold separately.
- Ensure that the cap is facing upward. If the cap is facing sideways or downward, it cannot provide an effective means for liquid proofing.

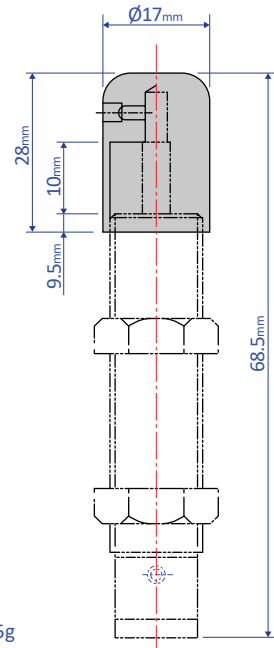

Mass 25g

Square flange OP-040KB

- Once the attachment site is determined, use the main unit's nut to securely fasten in place.

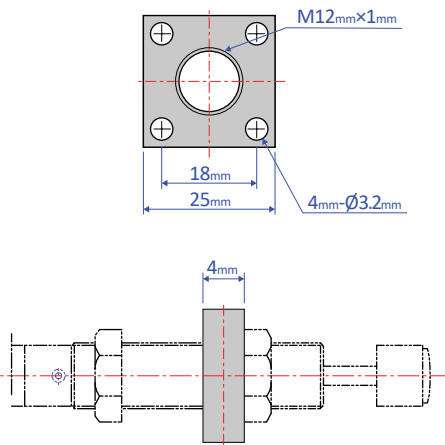

Mass 15 g

Holder with a switch OP-030KB-2

- Although a holder with a switch can be ordered on its own, we strongly recommend ordering one with the main unit. Please include the main unit's model number when placing an order.

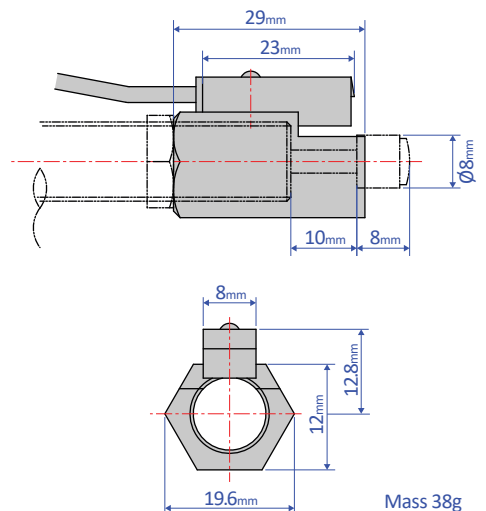

Mass 38g