



RVT70HSLFWN00

IPS LVDS 7.0" LCD TFT DATASHEET

Rev.1.3  
2021-11-23

ITEM	CONTENTS	UNIT
LCD Type	TFT/Transmissive/Normally black/IPS	/
Size	7.0	Inch
Viewing Direction	Free	/
Outside Dimensions (W x H x D)	181.60x 100.60 x 6.23	mm
Active Area (W x H)	154.21 x 85.92	mm
Pixel Pitch (W x H)	0.1506 x 0.1432	mm
Resolution	1024 (RGB) x 600	/
Brightness	1000	cd/m <sup>2</sup>
LCD Interface Type	LVDS	/
LCD Driver	EK79001HK+EK73215BCGA	/
Color Depth	16.7 M	/
Pixel Arrangement	RGB Vertical Stripe	/
With/Without Touch	Without Touch Panel	/
Surface Treatment	Anti-Glare	/
Weight	177	g

**Note 1:** RoHS3 compliant**Note 2:** LCM weight tolerance:  $\pm 5\%$ .



## 1. REVISION RECORD

REV NO.	REV DATE	CONTENTS	REMARKS
1.0	2020-08-05	Initial Release	
1.1	2021-07-29	Updating new template	
1.2	2021-10-01	Add info about driver IC of LCD Update chapter 11.1 TFT assignment	
1.3	2021-11-23	Add notes about "GRB (Global Reset Pin)" <ul style="list-style-type: none"><li>• Add notes to TFT pin 5, RESET</li><li>• Sub chapter 13.3 is updated</li></ul> Delete the redundant notes about "CABC_EN"	



## 2. CONTENTS

1.	REVISION RECORD.....	2
2.	CONTENTS.....	3
3.	MODULE CLASSIFICATION INFORMATION.....	4
4.	ASSEMBLY GUIDE.....	5
4.1	Mounting frame.....	5
5.	MODULE DRAWING.....	6
6.	ABSOLUTE MAXIMUM RATINGS.....	7
7.	ELECTRICAL CHARACTERISTICS.....	7
8.	BACKLIGHT ELECTRICAL CHARACTERISTICS.....	7
9.	POWER CONSUMPTION.....	8
10.	ELECTRO-OPTICAL CHARACTERISTICS.....	9
11.	BLOCK DIAGRAM.....	11
12.	INTERFACES DESCRIPTION.....	12
12.1	TFT assignment.....	12
13.	TIMING CHARACTERISTICS.....	14
13.1	Parallel RGB timing characteristic.....	14
13.1.1	DE MODE.....	14
13.1.2	HV MODE – Horizontal input timing.....	14
13.1.3	HV MODE – Vertical input timing.....	14
13.1.4	Data input format.....	15
13.2	AC characteristics.....	15
13.3	Power ON/OFF sequence.....	17
14.	INSPECTION.....	18
14.1	Inspection condition.....	18
14.2	Inspection standard.....	19
15.	RELIABILITY TEST.....	20
16.	LEGAL INFORMATION.....	21



### 3. MODULE CLASSIFICATION INFORMATION

RV	T	70	H	S	L	F	W	N	00
1.	2.	3.	4.	5.	6.	7.	8.	9.	10.

NO.	PARAMETER	SYMBOL
1.	BRAND	RV – Riverdi
2.	PRODUCT TYPE	T – TFT Standard
3.	DISPLAY SIZE	70 – 7.0”
4.	MODEL SERIAL NO.	H – High Brightness, IPS
5.	RESOLUTION	S – 1024 x 600 px
6.	INTERFACE	L – TFT LCD, LVDS
7.	FRAME	F – With Mounting Metal Frame
8.	BACKLIGHT TYPE	W – LED White
9.	TOUCH PANEL	N – Without Touch Panel
10.	VERSION	00 – (00-99)

## 4. ASSEMBLY GUIDE

### 4.1 Mounting frame

For dimensions 3.5", 4.3", 5.0", 7.0" and 10.1", the product with mounting frame version is available. Thanks to the four catches attached to the side, frame provides strong assembly to the surface by mounting element (like the screw, see Figure 1). The frames are specially designed to fit Riverdi products perfectly. The diameter of the mounting hole is 3.5mm.

*Figure 1. Mounting frame*

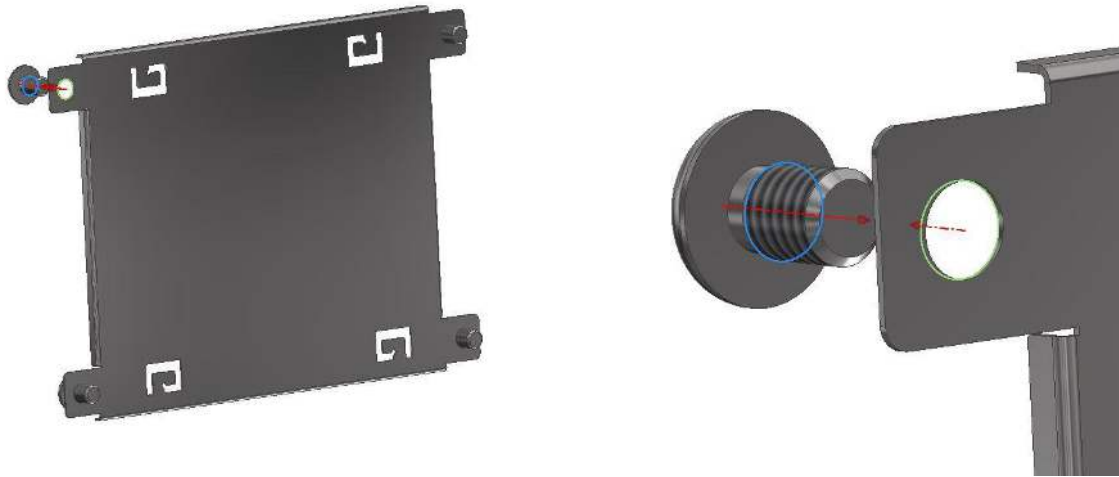

Revision:	Changes:	Date:
1.0	Initial Case	2020.07.03
1.1	Dimensions Overhaul	2021.06.24

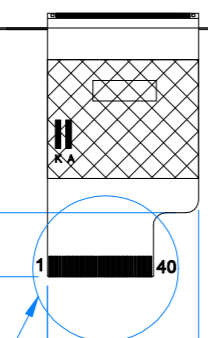
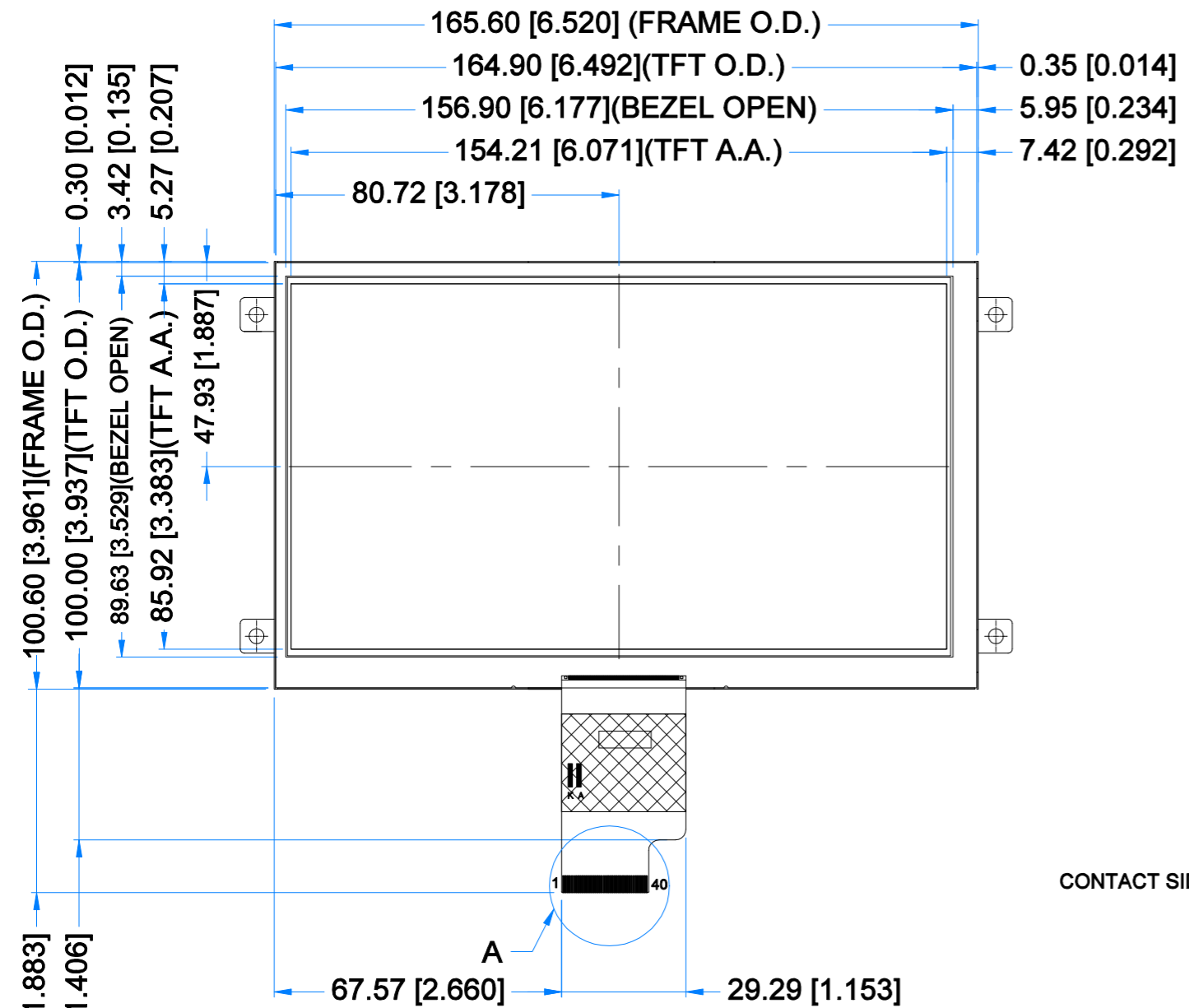

DETAIL A  
SCALE 2:1

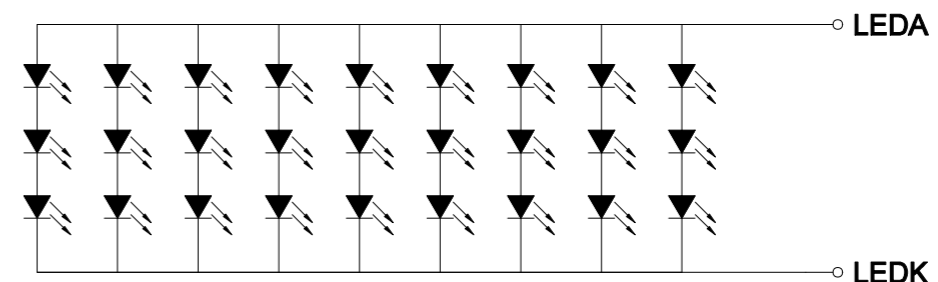
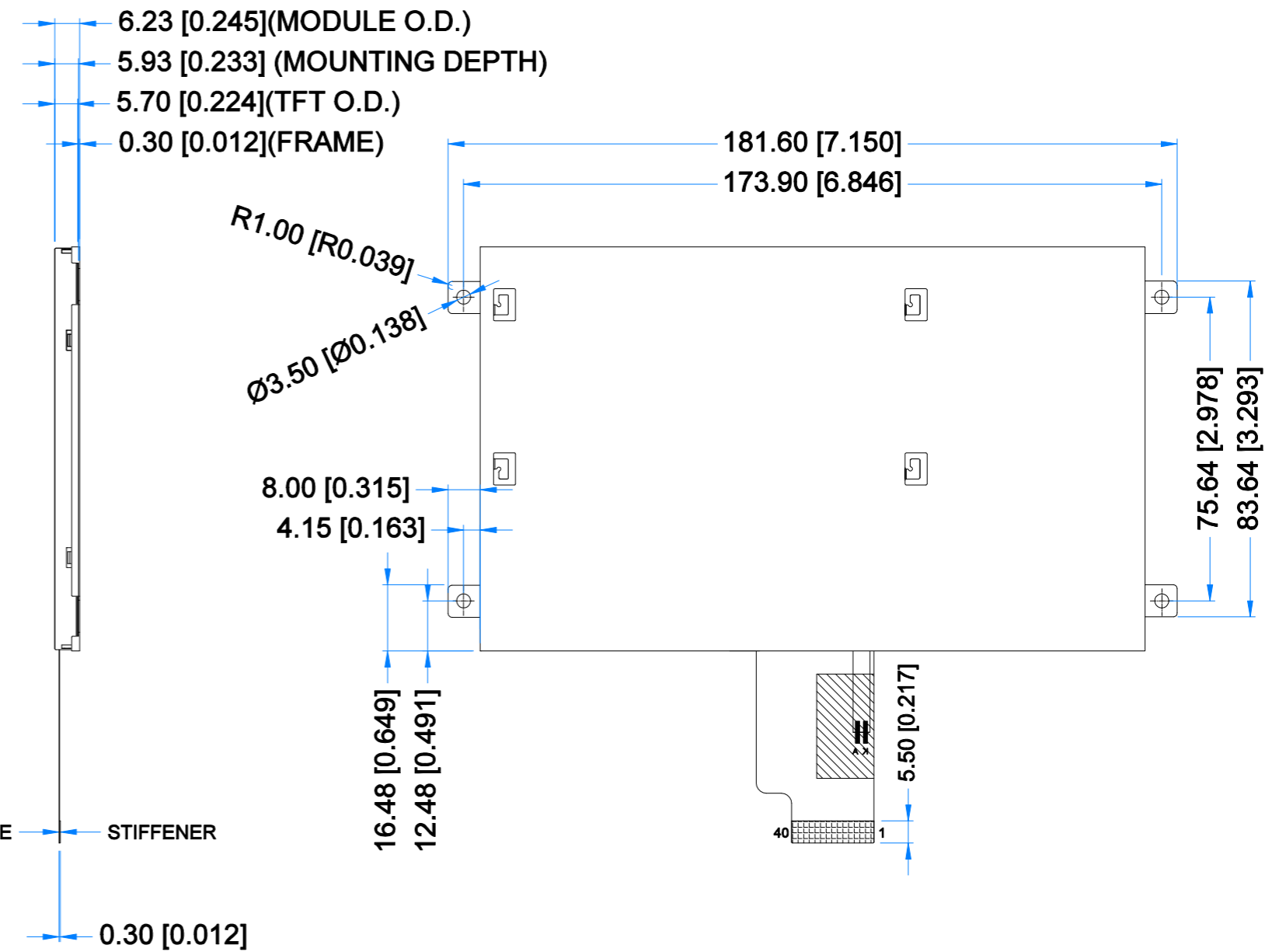
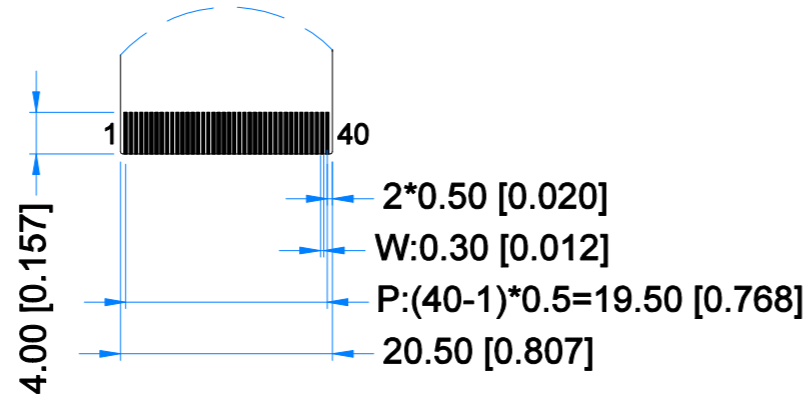

LED DIAGRAM CIRCUIT

**TFT NOTES:**  
1. LCD TYPE: TFT, TRANSMISSIVE, NORMALLY BLACK, IPS  
2. RESOLUTION: 1024x600  
3. VIEWING ANGLE: FREE  
4. INTERFACE: LVDS  
5. DRIVER IC: EK79001HK+EK73215BCGA  
6. LOGIC VOLTAGE: 3.3V  
7. SURFACE LUMINANCE: 1000cd/m<sup>2</sup>  
8. BACKLIGHT: 27 CHIP WHITE LED I<sub>F</sub>=270mA, V<sub>F</sub>= 9.6V

**GENERAL NOTES:**  
1. OPERATING TEMPERATURE: -20°C ~ 70°C  
2. STORAGE TEMPERATURE: -30°C ~ 80°C  
3. WITHOUT INDIVIDUAL TOLERANCE:  
±0.2mm[0.008inch]  
4. RoHS COMPLIANT

PN: RVT70HSLFWN00  
SN:  
DRAWN: M.Natywa  
CHECKED: K.Brodacka  
APPR:



2021.06.24 1:1.46  
2021.07.07 [mm]  
ISO A3 P. 1 of 1



## 6. ABSOLUTE MAXIMUM RATINGS

PARAMETER	SYMBOL	MIN	MAX	UNIT
Power for Circuit Driving	VDD	-0.3	3.96	V
	AVDD	-0.5	14.85	
	VGH	-0.3	40	
	VGL	-20.0	0.3	
Operating Temperature	T <sub>OP</sub>	-20	70	°C
Storage Temperature	T <sub>ST</sub>	-30	80	°C
Operating Humidity (@ 25 ± 5°C)	RH	10%	-	RH
Storage Humidity (@ 25 ± 5°C)	RH	10%	-	RH

## 7. ELECTRICAL CHARACTERISTICS

PARAMETER	SYMBOL	MIN	TYP	MAX	UNIT	NOTE
Supply Voltage for Module	DVDD	3.0	3.3	3.6	V	
	VGH	17	18	19		
	VGL	-6.6	-6.0	-5.4		
	AVDD	9.4	9.6	9.8		
	VCOM	3.6	3.8	4.0		
Current of Power Supply	IDD	-	30	45	mA	DVDD = 3.3V
	IADD	-	35	45	mA	AVDD = 9.6V
	IGH	-	0.5	1	uA	VGH = 18V
	IGL	-	0.5	1	mA	VGL = -6V
Input Voltage 'H' level	V <sub>IH</sub>	0.7DVDD	-	DVDD	V	Note 1
Input Voltage 'L' level	V <sub>IL</sub>	0	-	0.3VDD	V	Note 1

**Note 1.** STHL, STHR, OEH, L/R, CPH1÷CPH3, STVD, STVU, OEV, CKV, U/D.

## 8. BACKLIGHT ELECTRICAL CHARACTERISTICS

PARAMETER	SYMBOL	MIN	TYP	MAX	UNIT	NOTE
Backlight Driving Voltage	V <sub>F</sub>	9.0	9.6	10.2	V	
Backlight Driving Current	I <sub>F</sub>	-	270	-	mA	
Backlight Power Consumption	W <sub>BL</sub>	-	2592	-	mW	
LED Lifetime	-	-	50,000	-	hours	Note 1

**Note 1.** If LED is driven by high current, the lifetime of LED will be reduced. Operating life means brightness goes down to 50% initial brightness. Typical operating lifetime is estimated data.

## 9. POWER CONSUMPTION

PARAMETER	SYMBOL	CONDITION	MIN	TYP	MAX	UNIT	NOTE
Gate on Power Current	IVGH	VGH=18V	-	0.5	1	mA	Note 1
Gate off Power Current	IVGL	VGL=6V	-	0.5	1		
Digital Power Current	IDVDD	DVDD=3.3V	-	30	45		
Analog Power Current	IAVDD	AVDD=9.6 V	-	35	45		
Total Power Consumption	PC		-	447	604	mW	

**Note.** Typ. Specification: Gray-level test pattern; Max Specification: Black test pattern



256ay patten



black pattern





## 10. ELECTRO-OPTICAL CHARACTERISTICS

Optical characteristics are determined after the unit has been 'ON' and stable for approximately 30 minutes in a dark environment at 25 °C. The values specified are at an approximate distance 500mm from the LCD surface at a viewing angle of  $\Phi$  and  $\theta$  equal to 0°.

ITEM	SYMBOL	CONDITION	MIN	TYP	MAX	UNIT	RMK	NOTE
Response Time	Tr+Tf	$\theta=0^\circ$ $\phi=0^\circ$ Ta=25 °C	-	35	-	ms	FIG 2.	4
Contrast Ratio	Cr		-	800	-	---	FIG 3.	1
Luminance Uniformity	$\delta$ WHITE		-	75	-	%	FIG 3.	3
Surface Luminance	Lv		-	1000	-	cd/m <sup>2</sup>	FIG 3.	2
Viewing Angle Range	$\theta$	$\phi = 90^\circ$	-	85	-	deg	FIG 4.	6
		$\phi = 270^\circ$	-	85	-	deg	FIG 4.	
		$\phi = 0^\circ$	-	85	-	deg	FIG 4.	
		$\phi = 180^\circ$	-	85	-	deg	FIG 4.	
CIE (x, y) Chromaticity	Rx	$\theta=0^\circ$ $\phi=0^\circ$ Ta=25 °C	0.578	0.618	0.658	-	FIG 3.	5
	Ry		0.489	0.329	0.369	-		
	Gx		0.376	0.416	0.456	-		
	Gy		0.493	0.533	0.573	-		
	Bx		0.071	0.111	0.151	-		
	By		0.108	0.148	0.188	-		
	Wx		0.270	0.310	0.350	-		
	Wy		0.290	0.330	0.370	-		

**Note 1.** Contrast Ratio (CR) is defined mathematically as below, for more information see Figure 3.

$$\text{Contrast Ratio} = \frac{\text{Average Surface Luminance with all white pixels (P1, P2, P3, P4, P5)}}{\text{Average Surface Luminance with all black pixels (P1, P2, P3, P4, P5)}}$$

**Note 2.** Surface luminance is the LCD surface from the surface with all pixels displaying white. For more information see Figure 3.

$$Lv = \text{Average Surface Luminance with all white pixels (P1, P2, P3, P4, P5)}$$

**Note 3.** The uniformity in surface luminance  $\delta$  WHITE is determined by measuring luminance at each test position 1 through 5, and then dividing the minimum luminance of 5 points luminance by maximum luminance of 5 points luminance. For more information see Figure 3.

$$\delta \text{ WHITE} = \frac{\text{Minimum Surface Luminance with all white pixels (P1, P2, P3, P4, P5)}}{\text{Maximum Surface Luminance with all white pixels (P1, P2, P3, P4, P5)}}$$

**Note 4.** Response time is the time required for the display to transition from white to black (Rise Time, Tr) and from black to white (Decay Time, Tf). For additional information see Figure 2. The test equipment is Autronic-Melchers's ConoScope series.

**Note 5.** CIE (x, y) chromaticity, the x, y value is determined by measuring luminance at each test position 1 through 5, and then make average value.

**Note 6.** Viewing angle is the angle at which the contrast ratio is greater than 2. For TFT module the contrast ratio is greater than 10. The angles are determined for the horizontal or x axis and the vertical or y axis with respect to the z axis which is normal to LCD surface. For more information see Figure 4.

**Note 7.** For viewing angle and response time testing, the testing data is based on Autronic-Melchers's ConoScope series. Instruments for Contrast Ratio, Surface Luminance, Luminance Uniformity, CIE the test data is based on TOPCON's BM-5 photo detector.

Figure 2. The definition of response time

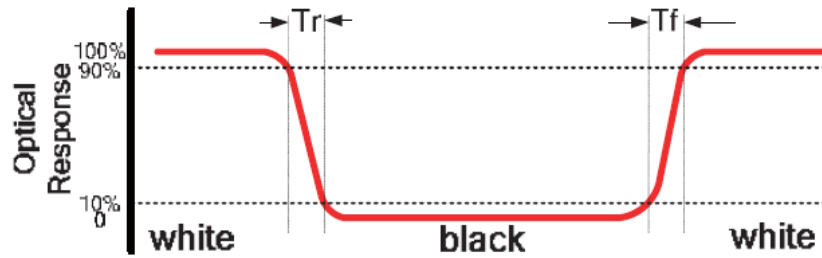
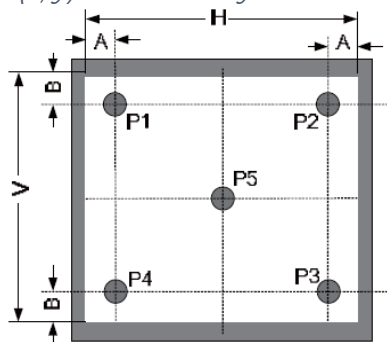

Figure 3. Measuring method for Contrast ratio, surface luminance, Luminance uniformity, CIE (x, y) chromaticity



A: 5mm

B: 5mm

H, V: Active Area

Light spot size  $\varnothing=5\text{mm}$ , 500mm distance from the LCD surface to detector lens.

Measurement instrument is TOPCON'S luminance meter BM-5

Figure 4. The definition of viewing angle

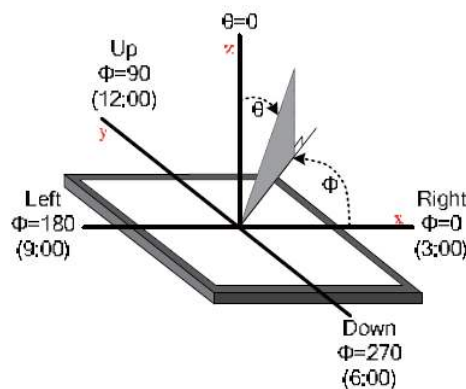



## 11. BLOCK DIAGRAM

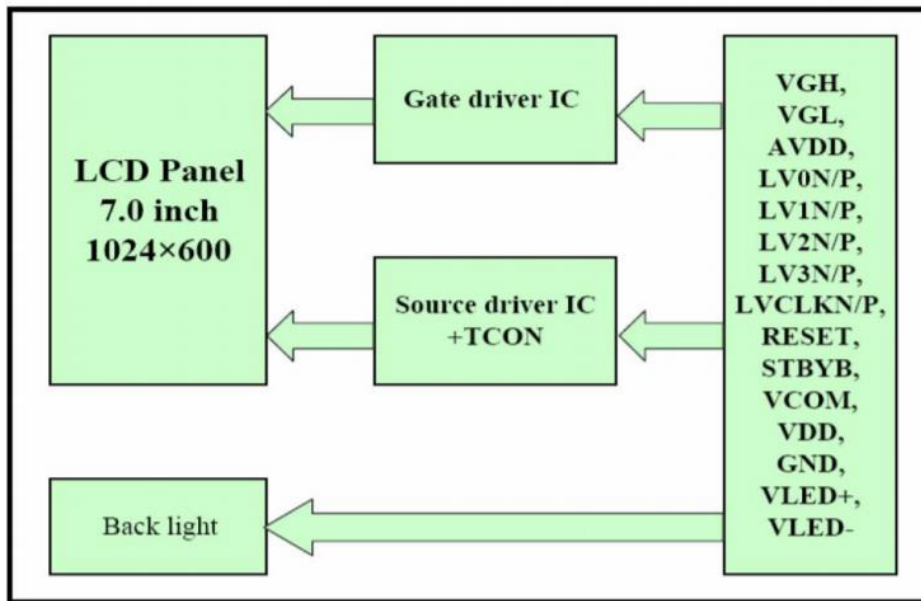



## 12. INTERFACES DESCRIPTION

### 12.1 TFT assignment

PIN NO.	SYMBOL	I/O	DESCRIPTION	NOTE
1	VCOM	P	Common voltage	
2	VDD	P	Power voltage for digital circuit	
3	VDD	P	Power voltage for digital circuit	
4	NC	-	No connection	
5	RESET	I	Global reset pin	Note 1
6	STBYB	I	Standby mode, normally pulled high STBYB = "1", normal operation STBYB = "0" timing controller, source driver will turn off, all output is High-Z.	
7	GND	P	Ground	
8	RXIN0-	I	-LVDS differential data input	
9	RXIN0+	I	+LVDS differential data input	
10	GND	P	Ground	
11	RXIN1-	I	-LVDS differential data input	
12	RXIN1+	I	+LVDS differential data input	
13	GND	P	Ground	
14	RXIN2-	I	-LVDS differential data input	
15	RXIN2+	I	+LVDS differential data input	
16	GND	P	Ground	
17	RXCLKIN-	I	-LVDS differential clock input	
18	RXCLKIN+	I	+LVDS differential clock input	
19	GND	P	Ground	
20	RXIN3-	I	-LVDS differential data input	
21	RXIN3+	I	+LVDS differential data input	
22	GND	P	Ground	
23	NC	-	No connection	
24	NC	-	No connection	
25	GND	P	Ground	
26	NC	-	No connection	
27	NC	-	No connection	
28	SELB	I	6-bit/8bit mode select	Note 2
29	AVDD	P	Power for analog circuit	
30	GND	P	Ground	
31	LED-	P	LED cathode	
32	LED-	P	LED cathode	
33	L/R	I	Horizontal inversion	Note 3,4
34	U/D	I	Vertical inversion	Note 3,4
35	VGL	P	Gate OFF voltage	
36	NC	-	No connection	
37	NC	-	No connection	
38	VGH	P	Gate ON voltage	
39	LED+	P	LED anode	
40	LED+	P	LED anode	



I: input, P: Power

**Note 1.** Global reset pin. Active Low to enter Reset State. Normally pull high.

It's necessary to connecting with an RC delay circuit for stability.

(GRB delay VDD larger than 1ms)

**Note 2.** If LVDS input data is 6 bits, SELB must be set to High;  
If LVDS input data is 8 bits, SELB must be set to Low.

**Note 3.** When L/R = "0", set right to left scan direction.  
When L/R = "1", set left to right scan direction.  
When U/D = "0", set top to bottom scan direction.

**Note 4.** U/D R/L Function Description

SETTING OF SCAN CONTROL INPUT		SCANNING DIRECTION
U/D	L/R	
GND	DVDD	Up to down, left to right
DVDD	GND	Down to up, right to left
GND	GND	Up to down, right to left
DVDD	DVDD	Down to up, left to right



## 13. TIMING CHARACTERISTICS

### 13.1 Parallel RGB timing characteristic

#### 13.1.1 DE MODE

PARAMETER	SYMBOL	VALUE			UNIT
		MIN.	TYP.	MAX.	
DCLK frequency (Frame rate 60Hz)	fclk	40.8	51.2	67.2	MHz
Horizontal display area	thd	1024			DCLK
HSYNC period time	th	1114	1344	1400	
HSYNC blanking	thb+thfp	90	320	376	
Vertical display area	tvd	600			H
VSYNC period time	tv	610	635	800	
VSYNC blanking	tvb+tvfp	10	85	200	

#### 13.1.2 HV MODE – Horizontal input timing

PARAMETER	SYMBOL	VALUE			UNIT
		MIN.	TYP.	MAX.	
Horizontal display area	thd	1024			DCLK
DCLK frequency (frame rate 60Hz)	fclk	44.9	51.2	63	MHz
1 Horizontal Line	th	1200	1344	1400	DCLK
HSYNC pulse width	thpw	1	-	140	
HSYNC back porch	thbp	160	160	160	
HSYNC front porch	thfp	16	160	216	

#### 13.1.3 HV MODE – Vertical input timing

PARAMETER	SYMBOL	VALUE			UNIT
		MIN.	TYP.	MAX.	
Vertical display area	tvd	600			H
VSYNC period time	tv	624	635	750	
VSYNC pulse width	tvpw	1	-	20	
VSYNC back porch	tvb	23	23	23	
VSYNC front porch	tVfp	1	12	127	

### 13.1.4 Data input format

Figure 4. 6-bit LVDS Input Timing chart

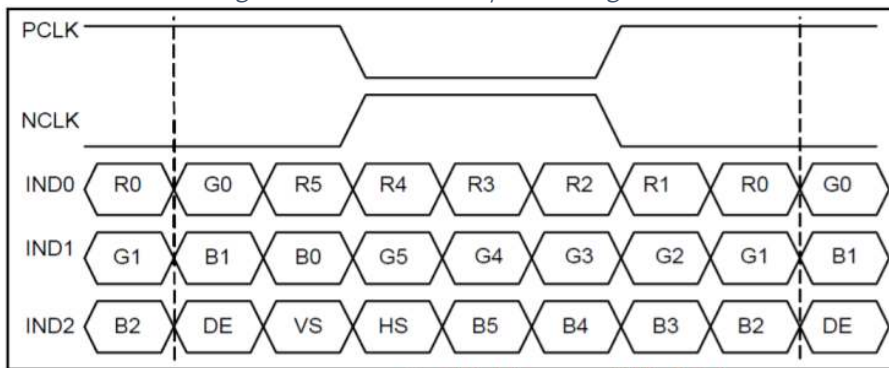
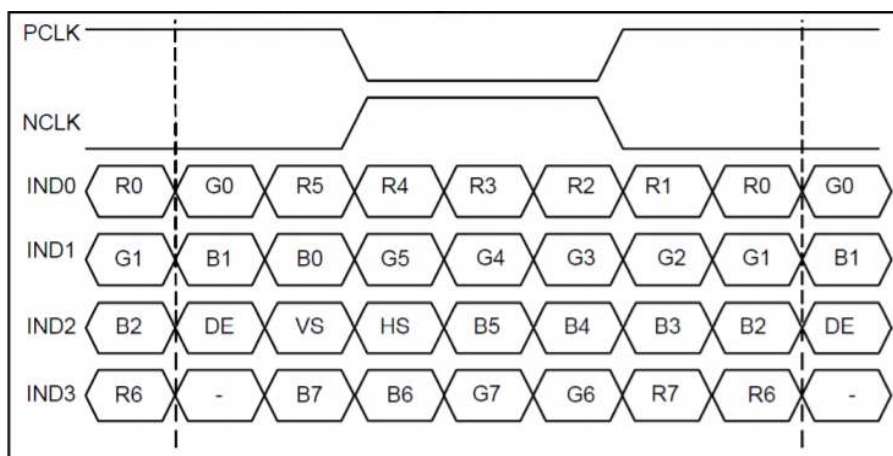
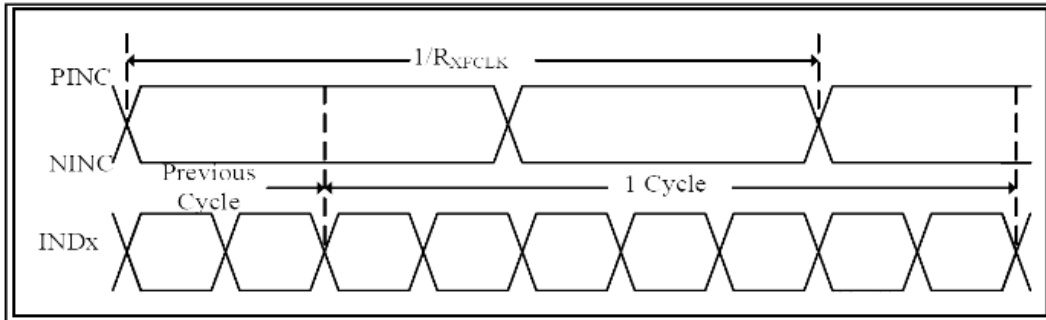

Figure 5. 8-bit LVDS Input Timing chart



### 13.2 AC characteristics

PARAMETER	SYMBOL	CONDITION	MIN	TYP	MAX	UNIT
Clock Frequency	RxFCLK		20	-	71	MHz
Input Data Skew Margin	TRSKM	VID =400mV RxVCM=1.2V RxFCLK=71MHz	500	-	-	ps
Clock High Time	TLVCH	-	-	$4/(7 \cdot RxFCLK)$	20	ns
Clock Low Time	TLVCL	-	-	$3/(7 \cdot RxFCLK)$	23	ns
PLL wake-up-time	TenPLL	-	-	-	150	us



LVDS timing(1)

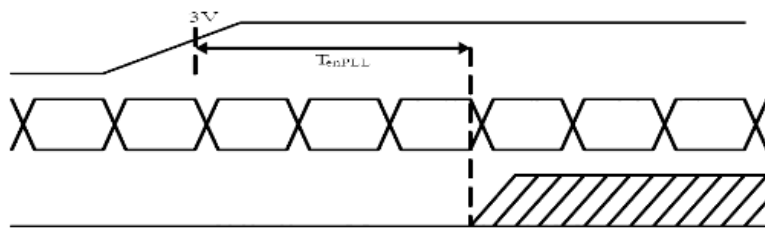

LVDS timing(2)

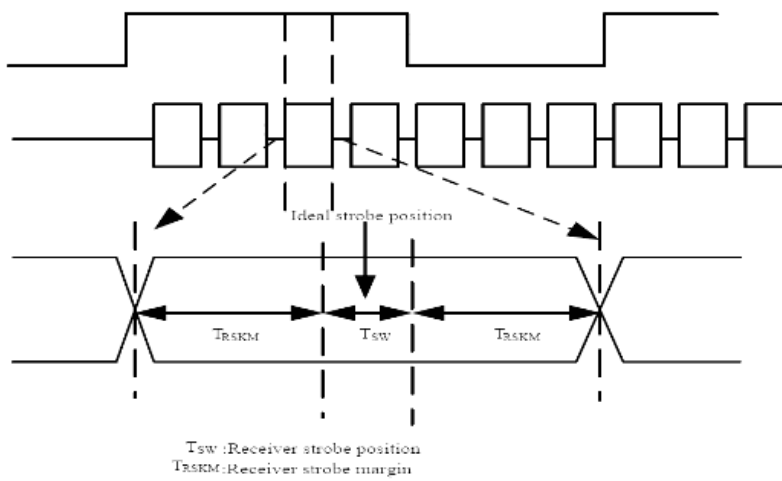

LVDS timing(3)





### 13.3 Power ON/OFF sequence

To prevent IC from power on reset fail, the rising time (TROP) of the digital power supply VDD should be maintained with the given specifications. Refer to “AC Characteristics” for more detail on timing.

There is another paragraph of sub-function description.

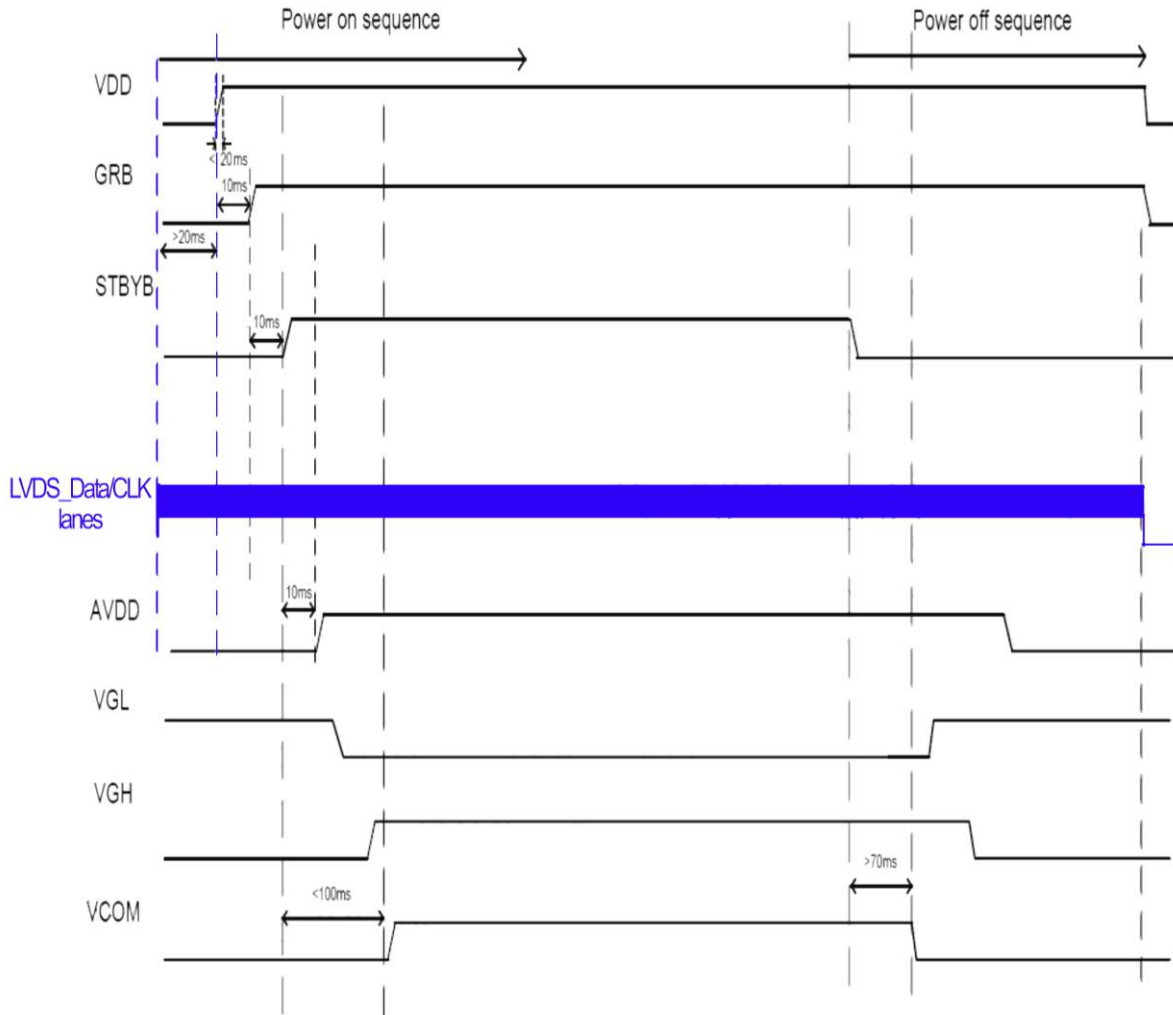

**Note 1:** GRB (Global Reset Pin) is internally connected to TFT interface pin 5, RESET.

Active Low to enter Reset State. Normally pull high.

It's necessary to connecting with an RC delay circuit for stability.

(GRB delay VDD larger than 1ms)

## 14. INSPECTION

Standard acceptance/rejection criteria for TFT module

### 14.1 Inspection condition

Ambient conditions:

- Temperature:  $25 \pm 2^{\circ}\text{C}$
- Humidity:  $(60 \pm 10) \%RH$
- Illumination: Single fluorescent lamp non-directive (300 to 700 lux)

Viewing distance:  $35 \pm 5\text{cm}$  between inspector bare eye and LCD.

Viewing Angle: U/D:  $45^{\circ}/45^{\circ}$ , L/R:  $45^{\circ}/45^{\circ}$

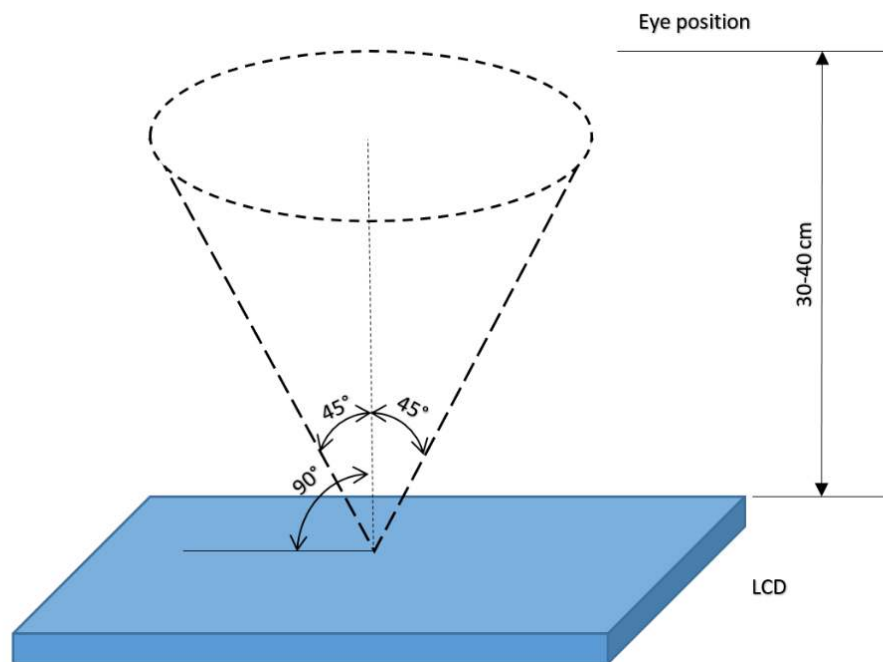

14.2 Inspection standard

ITEM		CRITERION		
Black spots, white spots, light leakage, Foreign Particle (round Type)	<p><math>D=(x+y)/2</math> Spots density: 10 mm</p>	Size =7"		
		Average Diameter	Qualified Qty	
		$D \leq 0.2$ mm	Ignored	
		$0.2 \text{ mm} < D \leq 0.3 \text{ mm}$	N≤3	
		$0.5\text{mm} < D$	Not allowed	
LCD black spots, white spots, light leakage (line Type)	<p>Spots density: 10 mm</p>	Size = 7"		
		Length	Width	Qualified Qty
		-	$W \leq 0.05$	Ignored
		$L \leq 5.0$	$0.05 < W \leq 0.1$	N≤3
		$5.0 < L$	$0.1 < W$	Not allowed
Bright/Dark Dots	Size = 7			
	Item	Qualified Qty		
	Bright dots	$N \leq 2$		
	Dark dots	$N \leq 3$		
	Total Bright and Dark Dots	$N \leq 4$		
Clear spots	Size ≥ 5"			
	Average Diameter	Qualified Qty		
	$D < 0.2$ mm	Ignored		
	$0.2 \text{ mm} < D < 0.3 \text{ mm}$	4		
	$0.3 \text{ mm} < D < 0.5 \text{ mm}$	2		
	$0.5 \text{ mm} < D$	0		
	Spots density: 10 mm			
Polarizer bubbles	Size ≥ 5"			
	Average Diameter	Qualified Qty		
	$D < 0.25$ mm	Ignored		
	$0.25 \text{ mm} < D < 0.5 \text{ mm}$	3		
	$0.5 \text{ mm} < D$	0		



## 15. RELIABILITY TEST

NO.	TEST ITEM	TEST CONDITION	NOTE
1	High Temperature Storage	80°C/120 hours	Note 1
2	Low Temperature Storage	-30°C/120 hours	
3	High Temperature Operating	70 °C /120 hours	
4	Low Temperature Operating	-20°C/120 hours	
5	High Temperature and High Humidity	Humidity 40°C, 90%RH, 120Hrs	
6	Thermal Cycling Test (No operation)	-20°C for 30min, 70°C for 30 min. 100 cycles. Then test at room temperature after 1 hour	Note 2
7	Vibration Test	Frequency: 10 ÷ 55 Hz. Stroke: 1.5 mm. Sweep: 10Hz ÷ 55Hz ÷ 10 Hz. 2 hours for each direction of X, Y, Z (Total 6 hours)	
8	Package Drop Test	Height: 60 cm 1 corner, 3 edges, 6 surfaces	

**Note 1.** Sample quantity for each test item is 5 ÷ 10 pcs.

**Note 2.** Before cosmetic and function test, the product must have enough recovery time, at least 2 hours at room temperature.



## 16.LEGAL INFORMATION

Riverdi grants the guarantee for the proper operation of the goods for a period of 12 months from the date of possession of the goods. If in a consequence of this guaranteed execution the customer has received the defects-free item as replacement for the defective item, the effectiveness period of this guarantee shall start anew from the moment the customer receives the defects-free item.

Information about device is the property of Riverdi and may be the subject of patents pending or granted. It is not allowed to copy or disclosed this document without prior written permission.

Riverdi endeavors to ensure that all contained information in this document is correct but does not accept liability for any error or omission. Riverdi products are in developing process and published information may be not up to date. Riverdi reserves the right to update and makes changes to Specifications or written material without prior notice at any time. It is important to check the current position with Riverdi.

Images and graphics used in this document are only for illustrative the purpose. All images and graphics are possible to be displayed on the range products of Riverdi, however the quality may vary. Riverdi is no liable to the buyer or to any third party for any indirect, incidental, special, consequential, punitive or exemplary damages (including without limitation lost profits, lost savings, or loss of business opportunity) relating to any product, service provided or to be provided by Riverdi, or the use or inability to use the same, even if Riverdi has been advised of the possibility of such damages.

Riverdi products are not fault tolerant nor designed, manufactured or intended for use or resale as on line control equipment in hazardous environments requiring fail-safe performance, such as in the operation of nuclear facilities, aircraft navigation or communication systems, air traffic control, direct life support machines or weapons systems in which the failure of the product could lead directly to death, personal injury or severe physical or environmental damage ('High-Risk Activities'). Riverdi and its suppliers specifically disclaim any expressed or implied warranty of fitness for High-Risk Activities. Using Riverdi products and devices in 'High-Risk Activities' and in any other application is entirely at the buyer's risk, and the buyer agrees to defend, indemnify and hold harmless Riverdi from all damages, claims or expenses resulting from such use. No licenses are conveyed, implicitly or otherwise, under any Riverdi intellectual property rights.

Hi, I am here to help you!  
If you have any additional  
questions, please contact  
our support via email:  
[contact@riverdi.com](mailto:contact@riverdi.com)

