

Network cable - NBC-M12MRX/1,0-94F - 1080716

Please be informed that the data shown in this PDF Document is generated from our Online Catalog. Please find the complete data in the user's documentation. Our General Terms of Use for Downloads are valid (<http://phoenixcontact.com/download>)



Network cable, Ethernet CAT6_A (10 Gbps) CAT6_A (10 Gbps), 8-position, PUR halogen-free, water blue RAL 5021, shielded (Advanced Shielding Technology), Plug angled M12 / IP67, coding: X, on free cable end, cable length: 1 m



Key Commercial Data

Packing unit	1 pc
GTIN	 4 055626 805610
GTIN	4055626805610
Custom tariff number	85444290
Country of origin	Poland

Technical data

Dimensions

Length of cable	1 m
-----------------	-----

Ambient conditions

Degree of protection	IP65
	IP67

General data

Rated current at 40°C	0.5 A
Rated voltage	48 V AC
	60 V DC
Number of positions	8
Signal type/category	Ethernet CAT6 _A , 10 Gbps
Standards/regulations	M12 connector IEC 61076-2-109

Network cable - NBC-M12MRX/1,0-94F - 1080716

Technical data

General data

Transmission characteristics (category)	CAT6 _A
Transmission speed	10 Gbps

Characteristics head 1

Head type	Plug angled M12 / IP67
No. of positions (pin connector pattern)	8
Coding	X (Data)
Color	black
Material (component)	CuZn (Contact)
	Ni/Au (Contact surface)
	PA 6.6 (Contact carriers)
	TPU, hardly inflammable, self-extinguishing (Grip)
	Zinc die-cast, nickel-plated (Screw connection)
Insulation resistance	≥ 100 MΩ
Insertion/withdrawal cycles	≥ 100
Torque	0.4 Nm
Ambient temperature (operation)	-25 °C ... 90 °C

Characteristics head 2

Head type	free cable end
Stripping length of the sheath (free conductor end)	45 mm ±10 mm

Standards and Regulations

Standards/specifications	M12 connector IEC 61076-2-109
--------------------------	-------------------------------

Cable

Cable type	Ethernet 10 Gbit
Cable type (abbreviation)	94F
UL AWM style	20963 (80°C/30 V)
Signal type/category	Ethernet CAT6 _A , 10 Gbps
Cable structure	4x2xAWG26/7; S/FTP
Conductor cross section	4x 2x 0.14 mm ²
AWG signal line	26
Conductor structure signal line	7x 0.16 mm
Core diameter including insulation	1.04 mm
Wire colors	white/blue-blue, white/orange-orange, white/green-green, white/brown-brown
Twisted pairs	2 cores to the pair
Type of pair shielding	Aluminum-lined foil
Overall twist	4 pairs for core

Network cable - NBC-M12MRX/1,0-94F - 1080716

Technical data

Cable

Shielding	Tinned copper braided shield
Optical shield covering	70 %
External sheath, color	water blue RAL 5021
Outer sheath thickness	0.65 mm
External cable diameter D	6.4 mm ±0.2 mm
Minimum bending radius, fixed installation	4 x D
Minimum bending radius, flexible installation	8 x D
Tensile strength GRP	≤ 100 N
Cable weight	42 kg/km
Outer sheath, material	PUR
Material conductor insulation	Foamed PE
Conductor material	Bare Cu litz wires
Insulation resistance	≥ 500 MΩ*km
Loop resistance	≤ 290.00 Ω/km
Cable capacity	47 nF/km
Wave impedance	100 Ω ±5 Ω (at 100 MHz)
Near end crosstalk attenuation (NEXT)	75.3 dB (with 1 MHz)
	66.3 dB (at 4 MHz)
	61.8 dB (at 8 MHz)
	60.3 dB (at 10 MHz)
	57.2 dB (at 16 MHz)
	55.8 dB (at 20 MHz)
	54.3 dB (at 25 MHz)
	52.8 dB (at 31.25 MHz)
	48.4 dB (at 62.5 MHz)
	45.3 dB (at 100 MHz)
	40.8 dB (at 200 MHz)
	39.3 dB (at 250 MHz)
	38.1 dB (at 300 MHz)
	36.3 dB (at 400 MHz)
	34.8 dB (at 500 MHz)
Power-summated near end crosstalk attenuation (PSNEXT)	72.3 dB (with 1 MHz)
	63.3 dB (at 4 MHz)
	58.8 dB (at 8 MHz)
	57.3 dB (at 10 MHz)
	54.2 dB (at 16 MHz)
	52.8 dB (at 20 MHz)

Network cable - NBC-M12MRX/1,0-94F - 1080716

Technical data

Cable

	51.3 dB (at 25 MHz)
	49.9 dB (at 31.25 MHz)
	45.4 dB (at 62.5 MHz)
	42.3 dB (at 100 MHz)
	37.8 dB (at 200 MHz)
	36.3 dB (at 250 MHz)
	35.1 dB (at 300 MHz)
	33.3 dB (at 400 MHz)
	31.8 dB (at 500 MHz)
Attenuation	3.1 dB (with 1 MHz)
	5.7 dB (at 4 MHz)
	8 dB (at 8 MHz)
	8.9 dB (at 10 MHz)
	11.2 dB (at 16 MHz)
	12.6 dB (at 20 MHz)
	14.1 dB (at 25 MHz)
	15.8 dB (at 31.25 MHz)
	22.5 dB (at 62.5 MHz)
	28.7 dB (at 100 MHz)
	41.4 dB (at 200 MHz)
	46.6 dB (at 250 MHz)
	51.4 dB (at 300 MHz)
	60.1 dB (at 400 MHz)
	67.9 dB (at 500 MHz)
Return loss (RL)	20 dB (with 1 MHz)
	23 dB (at 4 MHz)
	24.5 dB (at 8 MHz)
	25 dB (at 10 MHz)
	25 dB (at 16 MHz)
	25 dB (at 20 MHz)
	24.2 dB (at 25 MHz)
	23.3 dB (at 31.25 MHz)
	20.7 dB (at 62.5 MHz)
	19 dB (at 100 MHz)
	16.4 dB (at 200 MHz)
	15.6 dB (at 250 MHz)
	15.6 dB (at 300 MHz)

Network cable - NBC-M12MRX/1,0-94F - 1080716

Technical data

Cable

	15.6 dB (at 400 MHz)
	15.6 dB (at 500 MHz)
Signal runtime	5.13 ns/m
Shield attenuation	≥ 80 dB (at 30 ... 100 MHz)
Nominal voltage, cable	≤ 100 V
Test voltage Core/Core	700 V (50 Hz, 1 min.)
Test voltage Core/Shield	700 V (50 Hz, 1 min.)
Flame resistance	according to IEC 60332-1-2
Halogen-free	according to IEC 60754-1
Resistance to oil	in accordance with DIN EN 60811-2-1
Ambient temperature (operation)	-40 °C ... 80 °C (cable, fixed installation)
	-20 °C ... 80 °C (Cable, flexible installation)
Ambient temperature (installation)	-20 °C ... 80 °C
Ambient temperature (storage/transport)	-20 °C ... 80 °C
Shielded	yes

Environmental Product Compliance

China RoHS	Environmentally Friendly Use Period = 50 years
	For details about hazardous substances go to tab "Downloads", Category "Manufacturer's declaration"

Drawings

Schematic diagram

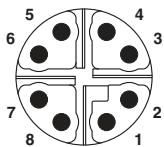

Pin assignment of M12 plug, 8-pos., X-coded, pin side view

Circuit diagram

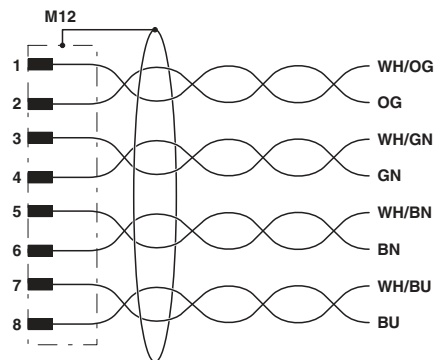

Contact assignment of the M12 plug

Network cable - NBC-M12MRX/1,0-94F - 1080716

Cable cross section



Ethernet 10 Gbit [94F]

Classifications

eCl@ss

eCl@ss 10.0.1	27060308
eCl@ss 11.0	27060307
eCl@ss 9.0	27060308

ETIM

ETIM 6.0	EC001262
ETIM 7.0	EC001855

Network cable - NBC-M12MRX/1,0-94F - 1080716

Classifications

UNSPSC

UNSPSC 18.0	26121604
UNSPSC 19.0	26121604
UNSPSC 20.0	26121604
UNSPSC 21.0	26121604

Approvals

Approvals

Approvals

UL Recognized / cUL Recognized / cULus Recognized

Ex Approvals

Approval details

UL Recognized		http://database.ul.com/cgi-bin/XYV/template/LISEXT/1FRAME/index.htm	FILE E 335024
Nominal voltage UN	30 V		
Nominal current IN	0.5 A		

cUL Recognized		http://database.ul.com/cgi-bin/XYV/template/LISEXT/1FRAME/index.htm	FILE E 335024
Nominal voltage UN	30 V		
Nominal current IN	0.5 A		

cULus Recognized	
------------------	---

Accessories

Accessories

Network cable - NBC-M12MRX/1,0-94F - 1080716

Accessories

Cable connector

Conductor connectors - SACC-CC-8QO SH ETH - 1414412



Cable connector, Ethernet CAT6_A (10 Gbps), 8-pos., halogen-free, shielded, insulation displacement connection, housing material: zinc die-cast, nickel-plated, outer cable diameter of 5 mm ... 9.7 mm

Circular connector (cable-side)

Data connector - SACC-MSX-8QO SH ETH SCO - 1411043



Data connector, Ethernet CAT6_A (10 Gbps), 8-position, halogen-free, shielded, Plug straight M12 SPEEDCON, Coding: X, Insulation displacement connection, knurl material: Zinc die-cast, nickel-plated, external cable diameter 5 mm ... 9.7 mm

Data connector - SACC-FSX-8QO SH ETH SCO - 1414586



Data connector, Ethernet CAT6_A (10 Gbps), 8-position, halogen-free, shielded, Socket straight M12 SPEEDCON, Coding: X, Insulation displacement connection, knurl material: Zinc die-cast, nickel-plated, external cable diameter 5 mm ... 9.7 mm

Data connector - VS-08-M12MS-10G-P SCO - 1417430



Data connector, Ethernet CAT6_A (10 Gbps), 8-position, shielded, Plug straight M12 SPEEDCON, Coding: X, Piercecon[®], knurl material: Zinc die-cast, nickel-plated, external cable diameter 4 mm ... 8 mm

Data connector - VS-08-M12MR-10G-P SCO - 1417443



Data connector, Ethernet CAT6_A (10 Gbps), 8-position, shielded, Plug angled M12 SPEEDCON, Coding: X, Piercecon[®], knurl material: Zinc die-cast, nickel-plated, external cable diameter 4 mm ... 8 mm

Network cable - NBC-M12MRX/1,0-94F - 1080716

Accessories

Data connector - SACC-M12MSX-8CT-CL SH - 1422844



Data connector, Ethernet CAT6_A (10 Gbps), PROFINET CAT6_A (10 Gbps), 8-position, shielded, Plug straight M12, Coding: X, Crimp connection, knurl material: Zinc die-cast, tin-plated, external cable diameter 6.5 mm ... 10 mm, without crimp contacts

Data connector - SACC-M12MRX-8CT-CL SH - 1422845



Data connector, Ethernet CAT6_A (10 Gbps), PROFINET CAT6_A (10 Gbps), 8-position, shielded, Plug angled M12, Coding: X, Crimp connection, knurl material: Zinc die-cast, tin-plated, external cable diameter 6.5 mm ... 10 mm, without crimp contacts

Corrugated pipe

Protective hose - WP-PA HF 13,0 BK - 3240681



Polyamide protective hose, inflammability class V0, UV resistant

Protective hose - WP-PA HF-HB 13,0 BK - 3240839



Polyamide protective hose, inflammability class HB, UV resistant

Cutting tools

Network cable - NBC-M12MRX/1,0-94F - 1080716

Accessories

Cable-cutting tool - CUTFOX 12 - 1212128



Cable cutter, for copper and aluminum up to 12 mm diameter (up to 35 mm²)

Diagonal cutter - CUTFOX-S VDE - 1212207



Diagonal cutter for hard (piano wire) and soft wires, VDE 1000 V AC/1500 V DC tested

Data plug

RJ45 connector - VS-08-RJ45-10G/Q - 1419001



RJ45 connector, IP20, CAT6_A, 8-pos., with QUICKON fast connection technology, for 26 ... 24 AWG 1-wire and 7-wire conductors, color: black

RJ45 connector - CUC-IND-C1ZNI-S/R4IE8 - 1421607



RJ45 connector, degree of protection: IP20, number of positions: 8, 1 Gbps, CAT5 (IEC 11801:2002), material: Zinc die-cast, connection method: IDC fast connection, connection cross section: AWG 26- 24, cable outlet: straight, color: green, Ethernet

RJ45 connector - CUC-IND-C1ZNI-T/R4IE8 - 1421877



RJ45 connector, degree of protection: IP20, number of positions: 8, 1 Gbps, CAT5 (IEC 11801:2002), material: Zinc die-cast, connection method: IDC fast connection, connection cross section: AWG 26- 24, cable outlet: angled, Ethernet

Network cable - NBC-M12MRX/1,0-94F - 1080716

Accessories

RJ45 connector - CUC-IND-C1ZNI-B/R4IE8 - 1421876



RJ45 connector, degree of protection: IP20, number of positions: 8, 1 Gbps, CAT5 (IEC 11801:2002), material: Zinc die-cast, connection method: IDC fast connection, connection cross section: AWG 26- 24, cable outlet: angled, Ethernet

RJ45 connector - CUC-V06-C1PGY-S/R4CEA:1 - 1414406



RJ45 connector, degree of protection: IP67, 10 Gbps, CAT6_A, material: PA, connection method: Crimp connection, connection cross section: AWG 24- 27, cable outlet: straight, color: gray, Ethernet/PROFINET

RJ45 connector - CUC-V06-C1PBK-S/R4CEA:1 - 1414410



RJ45 connector, degree of protection: IP67, number of positions: 8, 10 Gbps, CAT6_A, material: PA, connection method: Crimp connection, connection cross section: AWG 24- 27, cable outlet: straight, color: black, Ethernet/PROFINET

RJ45 connector - VS-PPC-C1-RJ45-POBK-8I10G - 1422205



RJ45 connector, IP67, with push/pull interlocking (Version 14), plastic housing, for 10 Gbps, for 24 ... 27 AWG stranded conductors

Electronics pliers

Diagonal cutter - MICROFOX-SP-1 - 1212487



Electronic diagonal cutter, tapered head, without chamfer, with opening spring, non-reflective phosphate-treated surface, punched version

Network cable - NBC-M12MRX/1,0-94F - 1080716

Accessories

Protective cap

Sealing cap - PROT-M12 FS-PA-CHAIN - 1430873

M12 sealing cap made of plastic with fixing band, for sensor cables, for free M12 plugs



Safety locking

Locking clip - SAC-M12-EXCLIP-M - 1558988



Locking clip for the pin side of sensor/actuator cables with M12 connector and M12 connectors for assembly, for knurl diameter: 15 mm or for Allen key with a wrench size of 14 mm, prevents the disconnection of plug-in connections without tools

Screwdriver tools

Adapter insert - TSD-M SAC-BIT ADAPTER - 1212600



Adapter bit for TSD-M...torque tools, E6.3-1/4" drive with 4 mm hexagon to accommodate SAC bits

Tool - SAC BIT M12-D15 - 1208432



Nut for assembling sensor/actuator cables with M12 connector and M12 connectors for assembly, with a knurl diameter of 15 mm, for 4 mm hexagonal drive

Stripping tool

Network cable - NBC-M12MRX/1,0-94F - 1080716

Accessories

Stripping tool - WIREFOX 4 - 1212156



Stripping tool, for cables and conductors (especially for rubber and silicone insulations) from 0.1 - 4 mm², self-adjusting, stripping length of up to 18 mm, cutting capacity of up to 10 mm² stranded/1.5 mm² solid, replaceable stripping blade

Stripping tool - WIREFOX-E 4 - 1212704



Stripping tool, for cables and conductors (especially for rubber and silicone insulations) from 0.1 - 4 mm², self-adjusting, stripping length of up to 18 mm, cutting capacity of up to 10 mm² stranded/1.5 mm² solid, replaceable stripping blade

Stripping tool - WIREFOX 10 - 1212150



Stripping tool, for cables and conductors from 0.02 - 10 mm², self-adjusting, stripping length of up to 18 mm, cutting capacity of up to 10 mm² stranded/1.5 mm² solid, replaceable stripping blade

Torque tool

Torque screwdriver - TSD 04 SAC - 1208429



Torque screwdriver, with preset torque of 0.4 Nm and 4 mm hexagonal drive for M12 connectors

Torque screwdriver - TSD-M 1,2NM - 1212224



Torque screw driver, accuracy as per EN ISO 6789 standard, adjustable from 0.3 - 1.2 Nm

Network cable - NBC-M12MRX/1,0-94F - 1080716

Accessories

Stripping tool - VS-CABLE-STRIP-VARIO - 1657407



Stripping tool, for the multi-level stripping of shielded cables

Protective hose adapter - WP-CTA POM 13,0 BK - 1422884



Protective hose adapter, for corrugated hoses with a nominal size of 13 (10 x 13), corrugated in parallel
