

60 V power Schottky rectifier

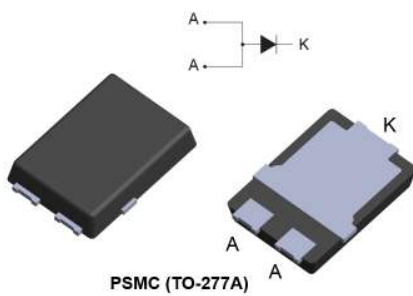

Features

- Low profile design – package height of 1.1 mm typ.
- Wettable flanks for automatic visual inspection
- Low forward voltage drop
- Avalanche capability
- ECOPACK[®]2 compliant

Applications

- Set-top box
- Battery charger
- DC/DC converter
- Notebook adapter
- Switching diode

Description

This 60 V Schottky barrier rectifier has been optimized for use in high frequency miniature DC/DC converters, reverse battery protection, battery chargers and adaptors.

Packaged in PSMC (TO-277A), the **STPS5L60SF** provides a high level of performance in a compact and flat package which can withstand high operating junction temperature.

Product status link	
STPS5L60SF	
Product summary	
Symbol	Value
$I_{F(AV)}$	5 A
V_{RRM}	60 V
T_j (max.)	150 °C
V_F (typ.)	0.40 V

1 Characteristics

Table 1. Absolute ratings (limiting values at 25 °C, unless otherwise specified, anode terminals short-circuited)

Symbol	Parameter	Value	Unit	
V _{RRM}	Repetitive peak reverse voltage	60	V	
I _{F(AV)}	Average forward current, $\delta = 0.5$ square pulse	T _c = 135 °C	5	A
I _{FSM}	Surge non repetitive forward current	t _p = 10 ms sinusoidal	220	A
P _{ARM}	Repetitive peak avalanche power	t _p = 10 μ s, T _j = 125 °C	280	W
T _{stg}	Storage temperature range	-65 to +175	°C	
T _j	Maximum operating junction temperature ⁽¹⁾	+150	°C	

1. $(dP_{tot}/dT_j) < (1/R_{th(j-a)})$ condition to avoid thermal runaway for a diode on its own heatsink.

Table 2. Thermal resistance parameters

Symbol	Parameter	Typ. value	Unit
R _{th(j-c)}	Junction to case	1.9	°C/W

For more information, please refer to the following application note:

- AN5088: Rectifiers thermal management, handling and mounting recommendations

Table 3. Static electrical characteristics (anode terminals short-circuited)

Symbol	Parameter	Test conditions	Min.	Typ.	Max.	Unit	
I _R ⁽¹⁾	Reverse leakage current	T _j = 25 °C	V _R = V _{RRM}	-		470	μ A
		T _j = 125 °C		-	50	150	mA
V _F ⁽²⁾	Forward voltage drop	T _j = 25 °C	I _F = 2.5 A	-		0.44	V
		T _j = 125 °C		-	0.30	0.35	
		T _j = 25 °C	I _F = 5 A	-		0.51	
		T _j = 125 °C		-	0.40	0.46	

1. Pulse test: t_p = 5 ms, $\delta < 2\%$

2. Pulse test: t_p = 380 μ s, $\delta < 2\%$

To evaluate the maximum conduction losses, use the following equation:

$$P = 0.24 \times I_{F(AV)} + 0.044 \times I_{F(RMS)}^2$$

For more information, please refer to the following application notes related to the power losses:

- AN604: Calculation of conduction losses in a power rectifier
- AN4021: Calculation of reverse losses in a power diode

1.1 Characteristics (curves)

Figure 1. Average forward current versus case temperature ($\delta = 0.5$)

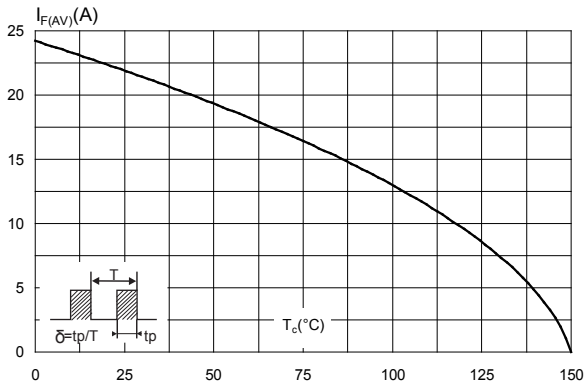

Figure 2. Relative variation of thermal impedance junction to case versus pulse duration

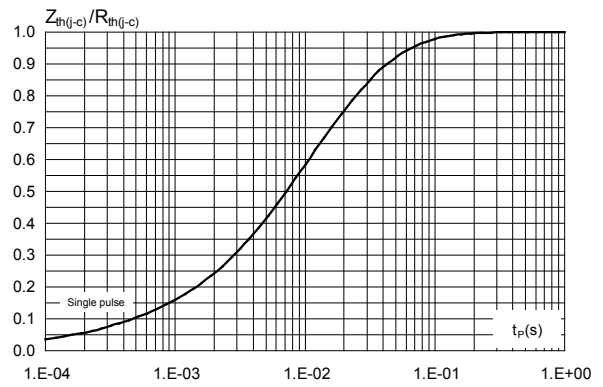

Figure 3. Reverse leakage current versus reverse voltage applied (typical values)

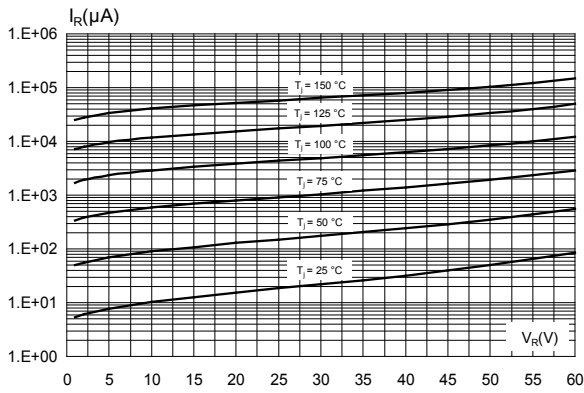

Figure 4. Junction capacitance versus reverse voltage applied (typical values)

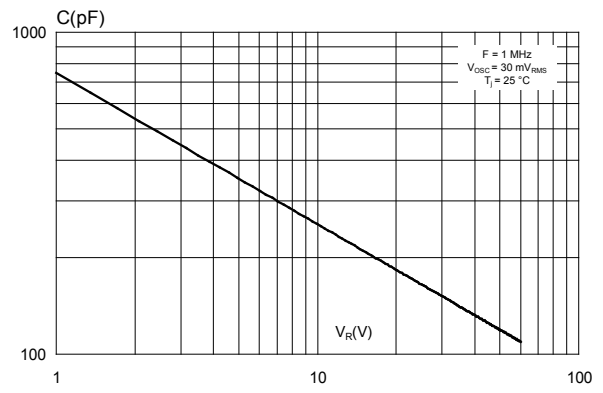

Figure 5. Forward voltage drop versus forward current (typical values)

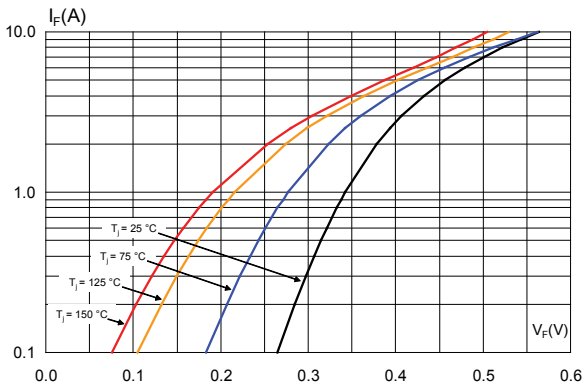

Figure 6. Normalized avalanche power derating versus pulse duration ($T_j = 125\text{ °C}$)

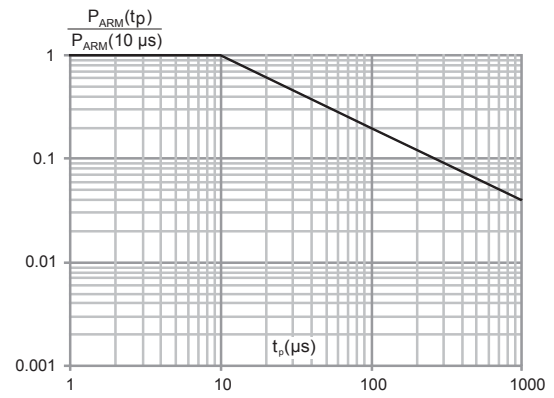
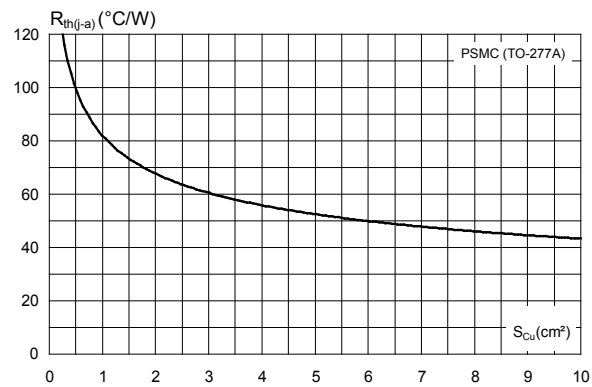

Figure 7. Thermal resistance junction to ambient versus copper surface under tab (typical values, epoxy printed board FR4, $e_{Cu} = 35\ \mu m$) (PSMC (TO-277A))



2 Package information

In order to meet environmental requirements, ST offers these devices in different grades of ECOPACK® packages, depending on their level of environmental compliance. ECOPACK® specifications, grade definitions and product status are available at: www.st.com. ECOPACK® is an ST trademark.

2.1 PSMC (TO-277A) package information

- Epoxy meets UL94,V0
- Cooling method : by conduction (C)

Figure 8. PSMC (TO-277A) package outline

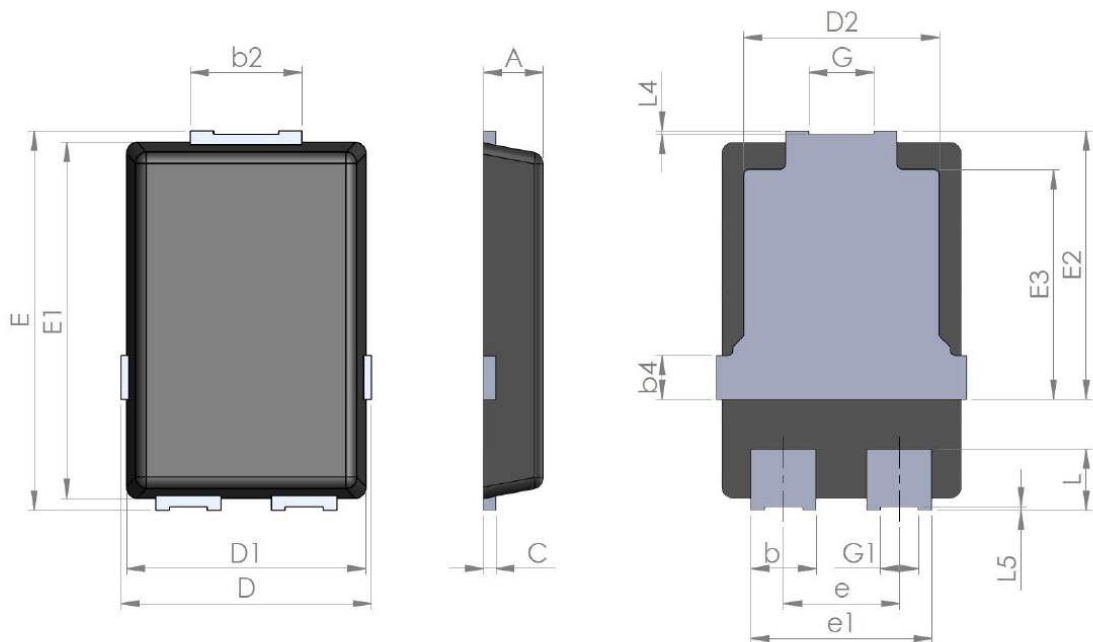
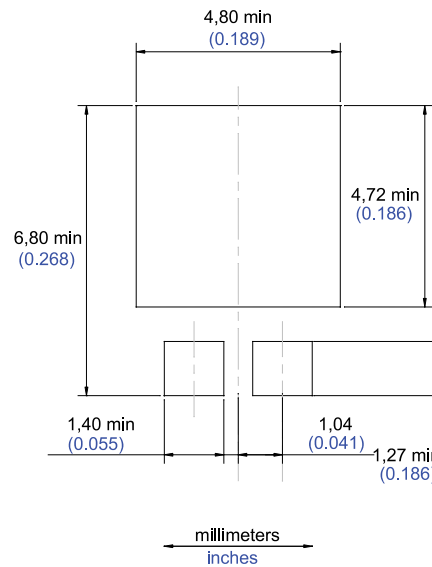

Table 4. PSMC (TO-277A) package mechanical data

Ref.	Dimensions					
	Millimeters			Inches (for reference only)		
	Min.	Typ.	Max.	Min.	Typ.	Max.
A	1.00	1.10	1.20	0.039	0.043	0.047
b	1.05	1.20	1.35	0.041	0.047	0.053
b2	1.90	2.05	2.20	0.075	0.081	0.087
b4		0.75			0.029	
C	0.15	0.23	0.40	0.006	0.009	0.016
D	4.45	4.60	4.75	0.175	0.181	0.187
D1	4.25	4.40	4.45	0.167	0.173	0.175
D2	3.40	3.60	3.70	0.134	0.142	0.146

Ref.	Dimensions					
	Millimeters			Inches (for reference only)		
	Min.	Typ.	Max.	Min.	Typ.	Max.
E	6.35	6.50	6.65	0.250	0.256	0.262
E1	6.05	6.10	6.15	0.238	0.240	0.242
E2	4.50	4.60	4.70	0.177	0.181	0.185
E3		3.94			1.55	
e		2.13			0.084	
e1		3.33			0.131	
G		1.20			0.047	
G1		0.70			0.027	
L	0.90	1.05	1.24	0.035	0.041	0.049
L4	0.02			0.0008		
L5	0.02			0.0008		

Figure 9. PSMC (TO-277A) package footprint in mm (in inches)



3 Ordering information

Table 5. Ordering information

Order code	Marking	Package	Weight	Base qty.	Delivery mode
STPS5L60SF	PS5L60	PSMC (TO-277A)	90 mg	6000	Tape and Reel

Revision history

Table 6. Document revision history

Date	Version	Changes
19-Jul-2018	1	Initial release.

IMPORTANT NOTICE – PLEASE READ CAREFULLY

STMicroelectronics NV and its subsidiaries (“ST”) reserve the right to make changes, corrections, enhancements, modifications, and improvements to ST products and/or to this document at any time without notice. Purchasers should obtain the latest relevant information on ST products before placing orders. ST products are sold pursuant to ST’s terms and conditions of sale in place at the time of order acknowledgement.

Purchasers are solely responsible for the choice, selection, and use of ST products and ST assumes no liability for application assistance or the design of Purchasers’ products.

No license, express or implied, to any intellectual property right is granted by ST herein.

Resale of ST products with provisions different from the information set forth herein shall void any warranty granted by ST for such product.

ST and the ST logo are trademarks of ST. All other product or service names are the property of their respective owners.

Information in this document supersedes and replaces information previously supplied in any prior versions of this document.

© 2018 STMicroelectronics – All rights reserved