

**DVI, HDMI INTERFACE CONTROLLER
FOR TFT PANEL**

Model: HSP-4096

Part number : 41761011X-3 or up

INSTRUCTIONS

CONTENTS

Page: **2. Introduction, How to Proceed, Usage Note, Disclaimer**
3. System design – Diagram of a suggested system
4. Assembly notes – Important information about system elements
6. Connection & Operation – How to use the controller
10. Connectors, pinouts & jumpers – Essential connection information
22. Controller dimensions
23. Application notes
25. Troubleshooting
26. Specifications
27. Appendix I – Signal support mode table
30. Appendix II – RS-232 control protocols and command set
37. Appendix III – Mapping definition
38. Appendix IV – DV remote control unit work for HSP-4096
39. Appendix V – Media failover function
40. Warranty, Caution & Limitation of Liability, Trademarks
41. Contact details
42. Revision History

It is essential that these instructions are read and understood before connecting or powering up this controller.

Introduction

Designed for LCD monitor and other flat panel display applications, the HSP-4096 is a feature rich interface controller for :

- TFT (active matrix) LCD panels of 4096x2160 resolutions in 60Hz with V-by-One interface.
- Support true 10 bits panel
- Support HDMI, DVI-I input.

HOW TO PROCEED

- Ensure you have all parts & that they are correct, refer to:
 - Connection diagram

Controller Solution Generator

Full web resource matching controllers & panels with **connection diagrams** for download.
See at : <http://www.digitalview.com/csg>

- Connector reference (in following section)
- Assembly notes
- Check controller switch & jumper settings (errors may damage the panel)
- Prepare the signal sources
- Connect the parts
- Understand the operation & functions

IMPORTANT USAGE NOTE

This equipment is for use by developers and integrators, the manufacturer accepts no liability for damage or injury caused by the use of this product. It is the responsibility of the developer, integrators or other user of this product to:

- Ensure that all necessary and appropriate safety measures are taken.
- Obtain suitable regulatory approvals as may be required.
- **Check power settings to all component parts before connection.**

DISCLAIMER

There is no implied or expressed warranty regarding this material.

SYSTEM DESIGN

A typical LCD based display system utilizing this controller is likely to comprise the following:

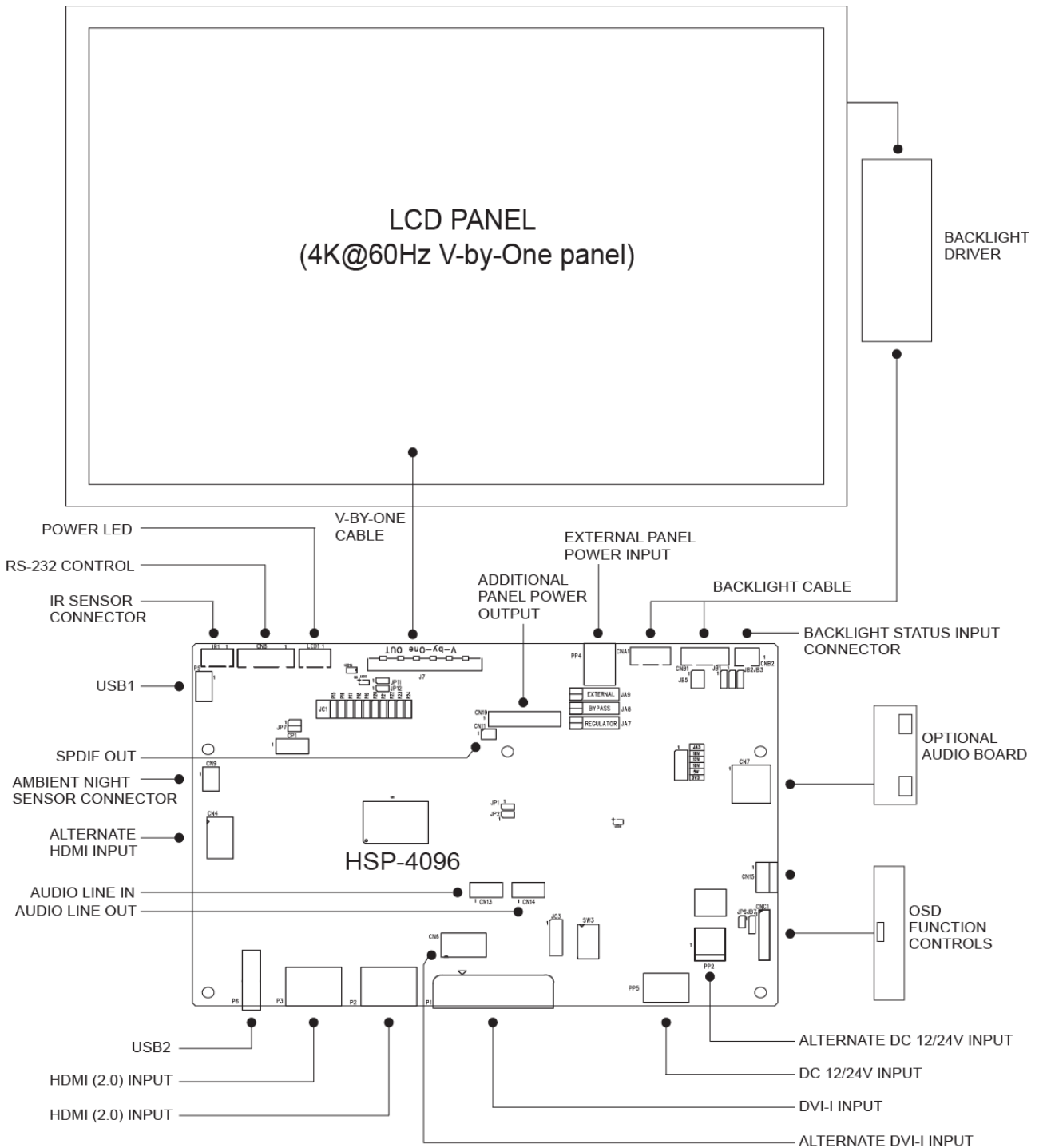

ASSEMBLY NOTES

This controller is designed for monitor and custom display projects using 4096x2160 resolution with V-by-One interface TFT panels. The following provides some guidelines for installation and preparation of a finished display solution.

Preparation: Before proceeding it is important to familiarize yourself with the parts making up the system and the various connectors, mounting holes and general layout of the controller. As much as possible connectors have been labeled. Guides to connectors and mounting holes are shown in the following relevant sections.

- 1. LCD Panel:** This controller is designed for typical V-by-One (8 lanes) interfaced panels with panel voltage 3.3V(4A), 5V(4A), 10V(4A), 12V(4A) or 18V(3A), External for 10V, 12V and 18V interface. Due to the variation between manufacturers of panels signal timing and other panel characteristics, factory setup and confirmation should be obtained before connecting to a panel. **(NOTE: Check panel power jumper settings before connection)**
- 2. LCD Controller:** Handle the controller with care as static charge may damage electronic components. Make sure correct jumper to match the target LCD panel.
- 3. Panel cable:** In order to provide a clean signal it is recommended that all panel cables (V-by-One signal) supplied by Digital View. Care should be taken when placing the cables to avoid signal interference.
- 4. Backlight driver:** This will be required for the backlight of an LCD, some LCD panels have a backlight driver built in. As LCD panels may have 1 or more backlight tubes and the power requirements for different panel backlights may vary it is important to match the backlight driver in order to obtain optimum performance. See Application notes page 23 for more information on connection.
- 5. Backlight cables:** Different backlight models require different cables and different pin assignment. Make sure correct cable pin out to match the backlight. Using wrong cable pin out may damage the backlight.
- 6. Function Controls:** The following section discusses the controls required and the section on connectors provides the detail. The controls are minimal: On/Off, Backlight Brightness (depends on backlight), OSD (5 momentary buttons) analog VR type or (8 momentary buttons) digital type.
- 7. Function controls cable:** The cables to the function switches should be of suitable quality and length so that impedance does not affect performance. Generally lengths up to 1 meter (3 feet) should be acceptable.
- 8. Optional LED:** The pin direction of the LED should be corrected for right color indication. Red color stands for standby. Green colors stands for signal on. The status LED is an optional part only, can be unconnected.
- 9. Optional IR sensor:** It is an optional part only, can be unconnected if not using IR remote control.
- 10. RS-232 control interface :** Serial control via CN8 interface port.
- 11. External panel power output :** Use for specific panel model.
- 12. Panel control signal :** Use for specific panel model.
- 13. SPDIF Audio output :** This port support SPDIF audio output from the HDMI / Display Port audio source inputted.
- 14. Ambient light sensor connection :** 3 ways connector provides interface for ambient light sensor kit (KIT 70220-3). Firmware customization is required for this function.
- 15. Backlight status input :** 2 ways connector provides interface for connection with the specific panel type which support the panel with backlight status monitoring function.
- 16. DVI-I input cable :** Plug the DVI cable to the connector P1 on the controller board.
- 17. HDMI input :** Plug the HDMI cable to the connector P2(HDMI 2.0) / P3(HDMI 2.0) on the controller board.
- 18. Alternate HDMI input :** This port gives alternate HDMI (1.4) input support.
- 19. Alternate DVI-I input :** This port gives alternate DVI-I input support.
- 20. Reserved for Audio adaptor board P/N 416940020-3:** The audio add-on board gives the audio input and output signal connection. It is an optional and reserved part only, can be unconnected if not using audio. It requires an audio cable P/N 426451800-3 to connect HSP-4096 (CN14) to the Audio Add-on Board (CN2).
CAUTION : The Audio Add-on Board P/N 416940020-3 can only operate with 12VDC power input environment.
- 21. Reserved for Audio extend cable :** The audio extend cable P/N 426009700-3 designs for connection between audio add on board P/N 416940020-3 and the controller. It is an optional and reserved part only, can be unconnected if not using audio.
- 22. Additional panel power input :** Provide additional (+10V/+12V/+18V) panel power input for driving high power consumption panels.

Specifications subject to change without notice

- 23. Power Input:** 12V/24VDC is required, this should be a regulated supply. The power rating is depending on the panel and inverter used. Normally, power supply with 3.5A current output should be enough for most of 4xCCFT panels. Although the controller provides power regulation for the LCD power this does not relate to the power supplied to the backlight driver. If an unregulated power supply is provided to an inverter any fluctuations in power may affect operation, performance and lifetime of the inverter and or backlight tubes.
- 24. External panel power input :** Allow to supply external power to the panel separately for max 3.3V (7A) or 5V (7A) or 10V (5A) or 12V (5A) or 18V (3.5A) via PP4 power input connector. Corresponding jumper setting of JA3, JA5 & JA6 are required for each panel power input by referring to page 14.
- 25. USB connector :** Media file (MP4, H.264) playback for failover function or firmware upgrade purpose
- **Power output:** Note the controller has an overall 3A current limit and the current available from the auxiliary power output will be dependent on the power input and other system requirements.
 - **Power Safety:** Note that although only 12V / 24VDC is required as 'power-in' a backlight driver for panel backlighting produces significantly higher voltages (the inverter does not connect to the ground plane). We strongly advise appropriate insulation for all circuitry.
 - **EMI:** Shielding will be required for passing certain regulatory emissions tests. Also the choice of external Controller to PC signal cable can affect the result.
 - **Ground:** The various PCB mounting holes are connected to the ground plane.
 - **Servicing:** The board is not user serviceable or repairable. Warranty does not cover user error in connecting up to the controller and is invalidated by unauthorized modification or repairs.
 - **Controller Mounting:** It is recommended that a clearance of at least 10mm is provided above and 5mm below the controller when mounted. Additionally consideration should be given to:
 - Electrical insulation.
 - Grounding.
 - EMI shielding.
 - Cable management. Note: It is important to keep panel signal cables apart from the inverter & backlight cables to prevent signal interference.
 - Heat & Ventilation: Heat generated from other sources, for example the backlight of a very high brightness panel may generate significant heat which could adversely affect the controller.
 - Other issues that may affect safety or performance.
 - **PC Graphics Output:** A few guidelines:
 - Signal quality is very important, if there is noise or instability in the PC graphics output this may result in visible noise on the display.
 - Refer to graphics modes table in specifications section for supported modes.
 - Non-interlaced & interlaced video input is acceptable.

IMPORTANT: Please read the Application Notes section for more information.

CONNECTION & OPERATION

CAUTION: Never connect or disconnect parts of the display system when the system is powered up as this may cause serious damage.

CONNECTION

Connection and usage is quite straight forward (it is useful to have the relevant connection diagram available at this time):

1. **LCD panel & backlight:** Connect the inverter/Backlight driver (if it is not built-in the panel) to the inverter/backlight connector of the LCD panel.
2. **V-by-One interface panels:** The controller board supports V-by-One interface 4K panel. Plug the cable to J7 for driving 4K 60Hz panel. And make sure the matching panel timings and correct jumper settings (JC1) by referring to the panel support table and jumper settings table in page 12-16.
3. **Backlight driver:** Plug the backlight cable to CNB1 and CNA1 (if necessary). Plug another end to the connector on the backlight of panel side.
4. **Function switch & Controller:** Plug the OSD switch mount cable to CNC1 on the controller board and another to the OSD switch mount.
5. **LED & Controller:** Plug in a 3-way with dual color LED to connector LED1 on the controller board.
6. **IR & Controller:** Plug in a 3-way with IR sensor to connector IR1 on the controller board.
7. **Jumpers & backlight & Panel voltage:** Particularly pay attention to the settings of JA3, JA7, JA8, JA9, JB2 and JB3. JB2 & JB3 are used for backlight control (read backlight specification and information on the jumper table to define the correct settings). JA3, JA7, JA8 and JA9 are used for panel voltage input (read panel specification and information on the jumper table to define the correct settings).
8. **Input signal cable & Controller:** Plug the corresponding signal input to the connector on the controller board.
9. **Power supply & Controller:** Plug the DC 12V/24V power in to the connector PP2 or PP5. You can consider to use DigitalView mating power cable P/N 426013710-3, 1000mm for PP5 connection.
10. **External panel power input :** Plug power cable : P/N 426013710-3 for external panel power input (3.3 (max 7A) / 5V (max 7A) / 10V (max. 5A) / 12V (max 5A) / 18V (max3.5)) for PP4 connection.
11. **Power on:** Switch on the controller board and panel by using the OSD switch mount.

General:

- If you are using supplied cables & accessories, ensure they are correct for the model of panel and controller.
- If you are making your own cables & connectors refer carefully to both the panel & inverter specifications and the section in this manual, "Connectors, Pinouts & Jumpers" to ensure the correct pin to pin wiring.

PC SETTINGS

The controller has been designed to take a very wide range of input signals however to optimize the PC's graphics performance we recommend choosing 60Hz vertical refresh rate – this will not cause screen flicker.

OPERATION

Once the system has been connected and switched on there are a number of functions available to adjust the display image as summarized in the following sections. The settings chosen will be saved for each mode independently.

LCD DISPLAY SYSTEM SETTINGS

NOTE: By way of explanation the following refers to a set of sample buttons that may be obtained as an option. In addition to power on/off and connection for backlight brightness the controller provides an On Screen Display of certain functions which are controlled by 5 momentary type buttons (analog VR type) or 8 momentary type buttons (digital type):

Controls	Analog VR type	Digital type
On/Off – turns controller board power on	VR toggle switch	On/Off button
Brightness – controls backlight brightness	Rotary VR	Brightness +/- buttons
Menu • Turns OSD menu On or Off (it will auto time off)	Menu button	Menu button
Select up • Moves the selector to the previous level function (up)	SEL UP	SEL UP
Select down • Moves the selector to the next level function (down) • Confirm the OSD selection	SEL DN	SEL DN
+ • Increase the OSD parameter values • Moves the selector to next function (forward)	+	+
- • Decrease the OSD parameter values • Moves the selector to previous function (backward)	-	-

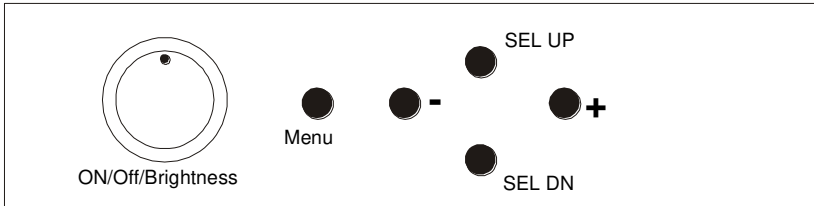

Analog VR type

12V / 24VDC power input :
Analog 10K VR Type OSD switch mount uses P/N 410680550-3 or up

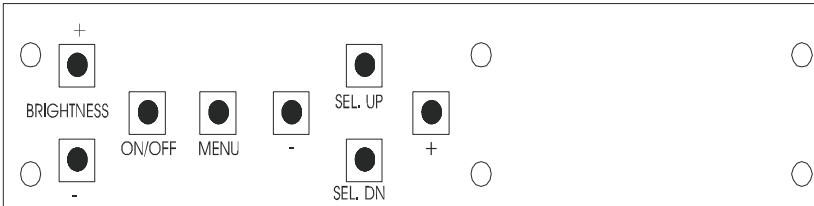

Digital type

12V / 24VDC power input :
Digital 10K Type OSD switch mount uses P/N 416100520-3 or up

OSD functions

	<p>Picture :</p> <p>Input Source ▶ Select the input video signal HDMI1 HDMI2 HDMI3 DVI VGA</p> <p>Auto Color Gain** : Auto Color Calibration</p> <p>Picture Setting ▶ Contrast [0~100] Default 50 : Increase/decrease panel contrast level, total: 100 steps Black Level [0~100] Default 50 : Increase/decrease panel brightness level, total: 100 steps Sharpness* [0~100] Default 50 : Increase/decrease sharpness, total: 100 steps Hue [0~100] Default 50 : Increase/decrease Hue level, total: 100 steps Saturation [0~100] Default 50 : Increase/decrease saturation, total: 100 steps</p> <p>Color Temperature ▶ 5000K 6500K 7500K 9300K User ▶ R [0~255] : Red Gain G [0~255] : Green Gain B [0~255] : Blue Gain</p> <p>Advance# ▶ H-Pos [0~100] : Move the image position horizontally V-Pos [0~100] : Move the image position vertically Clock [0~100] : Adjust the image horizontal size Phase [0~100] : Fine tune the data sampling position (adjust image quality) Auto Picture Setup : Auto adjust the image position, phase and size</p> <p>Aspect / Size ▶ 4:3 : scaling format in 4:3 Fill Screen : Default Enable full screen expansion for lower resolution Image 16:9 : scaling format in 16:9 1:1 : Display the exact image resolution on the screen without image expansion.</p> <p>Brightness [0~100] : Default 100 : Backlight brightness adjustment</p> <p>* Function in Video mode only ** Function in VGA only # Function in VGA mode only</p>
---	--



Utilities :

Menu language : English / French / Spanish

Setup ▶

Default Power : OFF / ON

ON – When the controller detects DC in, turn on the power. (Default)
OFF – When the controller detects DC in, stay in 'Stand-by' mode.

Auto Source Seek : On/Off (Default On) : Select Auto source select enable or disable.

Image Orientation ▶ Set the image orientation on screen

Normal (Default)

H-Flip

V-Flip

HV-Flip

Gamma : 1.8 / 2.0 / 2.2 / 2.4 / 2.6 (Default 2.2)

Failover On/Off (Default OFF) - See Appendix V in details.

Auto power : OFF / ON

ON – Enable soft power off function if absence of input signals
OFF – Disable soft power function

OSD ▶

OSD Time Out : ON / 5 Sec / 15 Sec / 30 Sec (Default) / 45 Sec / 60 Sec : Adjust the OSD menu timeout period

Transparent : 0% / 25% (Default) / 50% / 75% / 100% : Set OSD transparency

Reset to Factory Default ▶ Restore back to factory default values.
Are you sure ? Yes / No

Software Update (USB) : Firmware upgrade

Hot Key ▶

Hotkey 1 : Volume / Black Level / Contrast / Input Source / Aspect/Size / Saturation / Image Orientation / Brightness / Auto Picture Setup / Off

Hotkey 2 : Volume / Black Level / Contrast / Input Source / Aspect/Size / Saturation / Image Orientation / Brightness / Auto Picture Setup / Off

Brightness Setup :

Invert : OFF / ON : Invert for the backlight brightness

Control : D/A / PWM : Selection for voltage level dimming control / PWM dimming control

Frequency(Hz) : 100 ~ 440Hz in a step of 20

Min Level : 0 ~ 50% : Default the minimum backlight adjustment.



Audio :

Volume [0~100] : Default 50 : Increase/decrease volume level, total: 100 steps

Effective on Firmware V1.01.00.00 or up

CONNECTORS, PINOUTS & JUMPERS

The various connectors are:

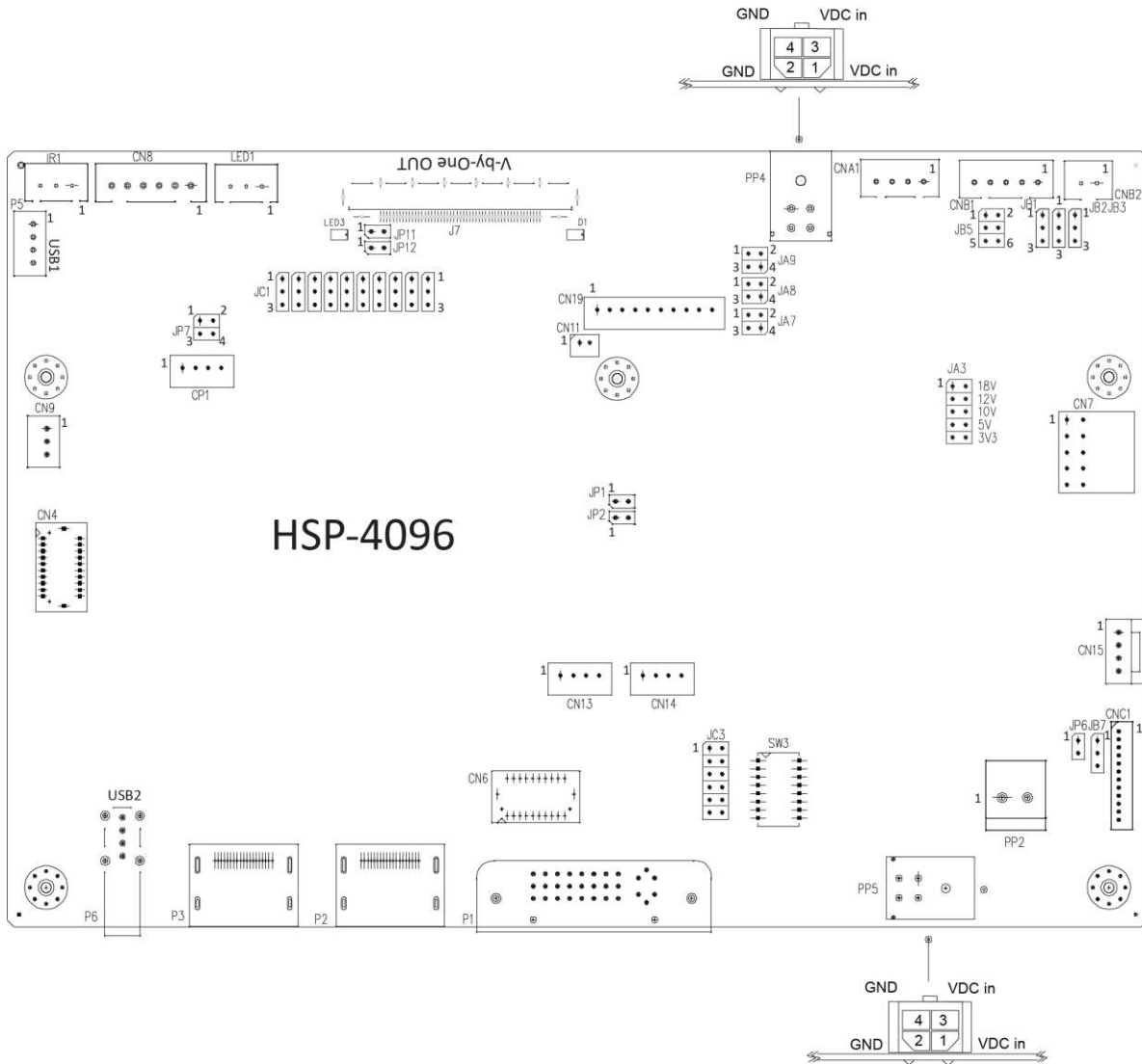

Summary: Connectors

Ref	Purpose	Description
CN4	On board internal connector for HDMI -- HDMI3	JST BM20B-SRDS (Matching type : SHDR-20V-S-B)
CN6	On board internal connector for DVI	JST BM29B-SRDS (Mating type : SHDR-20V-S-B) (Matching extend cable P/N: 426302900-3)
CN7	Audio board connector	Dual pin header 5x2, 0.1" pitch right angle (Matching audio add-on board P/N 416940020-3)
CN8	RS-232 serial control	JST 6-way, B6B-XH-A (Matching type : XHP-6)
CN9	Ambient light sensor connector	JST 3-way, B3B-PH-K (Matching type : PHR-3)
CN11	SPDIF Audio output	JST B2B-ZR (Matching type : ZHR-2) (Matching extend cable P/N 426007400-3)
CN13	Audio line in	JST B4B-ZR (Matching type : ZHR-4)
CN14	Audio line out	JST B4B-ZR (Matching type : ZHR-4) (Use audio cable P/N 426451800-3 to connect with audio add-on board P/N 416940020-3)
CN15	Power connector of IE-2000	Yeonho SMH200-04 (Matching type : SMH200-04) (Matching extend cable P/N:426307100-3)
CN19	Additional panel power output	JST B10B-PH-K (Matching type : PHR-10)
CP1	Reserved for engineering use	Reserved
CNA1	Auxiliary power output	JST 4-way, B4B-XH-A (Matching type : XHP-4) (Matching cable P/N 426040200-3)
CNB1	Backlight inverter	JST 5-way, B5B-XH-A (Matching type : XHP-5) (Matching cable P/N 426058300-3)

Specifications subject to change without notice

CNB2	Backlight status input connector	JST 2 way, B2B-XH-A (Matching type : XHP-2)
CNC1	OSD control	Hirose DF13A-12P-1.25H (Mating type : DF13-12S-1.25C) (Matching OSD switch mount cable P/N 426122200-3 (150mm) or 426122210-3 (250mm))
IR1	Infra-red sensor connector	JST 3-way, B3B-XH-A (Matching type : XHP-3)
J7	V-by-One panel signal output	JAE FI-RE51S-HF (Matching type : FI-RE51HL)
LED1	Power LED connector	3-pins header
P1	Single link DVI-I -- DVI / VGA -- VGA	DVI-I connector
P2	HDMI (2.0) -- HDMI1	HDMI connector
P3	HDMI (2.0) -- HDMI2	HDMI connector
P5	USB1	JST B4B-ZR (Matching type : ZHR-4)
P6	USB2	USB type-A connector
PP2	Power input (alternative)	DC power Molex 2 pin 0.156" pitch
PP4	External panel power input	Molex 43045-0400 compatible (Matching connector type : Molex 43025-0400 compatible) (Matching power cable : P/N 426013710-3)
PP5	12V/24VDC input power	Molex 43045-0400 compatible (Matching connector type : Molex 43025-0400 compatible) (Matching power cable : P/N 426013710-3)
SW3	Panel timing selection	8-way DIP Switch

Summary: Jumpers setting

Ref	Purpose	Note																																																
JA3	Panel power voltage select CAUTION: Incorrect setting can damage panel	See panel voltage setting table 1																																																
JA7	Panel power voltage select CAUTION: Incorrect setting will cause panel damage	See panel voltage setting table 1																																																
JA8	Panel power voltage select CAUTION: Incorrect setting will cause panel damage	See panel voltage setting table 1																																																
JA9	Panel power voltage select CAUTION: Incorrect setting will cause panel damage	See panel voltage setting table 1																																																
JB1	Backlight brightness voltage range	1-2 = 5V max 2-3 = 3.3V max																																																
JB2	Backlight inverter on/off control – signal level	2-3 = On/Off control signal 'High' = +5V 1-2 = On/Off control signal 'High' = +3.3V Open = On/Off control signal 'High' = Open collector CAUTION: Incorrect setting can damage inverter.																																																
JB3	Backlight inverter on/off control – polarity	1-2 = control signal 'high' = Backlight ON 2-3 = control signal 'low' = Backlight ON																																																
JB5	Backlight control type selection	1-2 = VR/Digital switch mount control 3-4 = Analog backlight brightness - voltage range 0~5V 5-6 = PWM (Pulse Width Modulation) brightness																																																
JB7	Backlight control voltage on CNB1 pin 4 (Function when JB5 sets 1-2 closed)	Open = For OSD switch mount control (Default) 1-2 = 0V 2-3 = 3.3V / 5V controlled by JB1																																																
JC1	<p>Panel Specification (V-by-One's pin assignment)</p> <table border="1"> <thead> <tr> <th>Pin</th> <th>Name</th> <th>Description</th> </tr> </thead> <tbody> <tr><td>12</td><td>GND</td><td>Ground</td></tr> <tr><td>13</td><td>GND</td><td>Ground</td></tr> <tr><td>14</td><td>GND</td><td>Ground</td></tr> <tr><td>15</td><td>NC</td><td>NO CONNECTION</td></tr> <tr><td>16</td><td>NC</td><td>NO CONNECTION</td></tr> <tr><td>17</td><td>NC</td><td>NO CONNECTION</td></tr> <tr><td>18</td><td>NC</td><td>NO CONNECTION</td></tr> <tr><td>19</td><td>NC</td><td>NO CONNECTION</td></tr> <tr><td>20</td><td>NC</td><td>NO CONNECTION</td></tr> <tr><td>21</td><td>NC</td><td>NO CONNECTION</td></tr> <tr><td>22</td><td>NC</td><td>NO CONNECTION</td></tr> <tr><td>23</td><td>NC</td><td>NO CONNECTION</td></tr> <tr><td>24</td><td>GND</td><td>Ground</td></tr> <tr><td>25</td><td>HTPDN</td><td>Hot plug detect</td></tr> <tr><td>26</td><td>LOCKN</td><td>Lock detect</td></tr> </tbody> </table> <p>Legend: <input type="checkbox"/> 1 <input type="checkbox"/> 2 <input type="checkbox"/> 3 Low or GND High NC</p> <p>1-2 close = High 2-3 close = Low or GND Open = NC</p> <p>* The setting of NC (No connection) is subject to the NC's state defined in panel specification.</p>	Pin	Name	Description	12	GND	Ground	13	GND	Ground	14	GND	Ground	15	NC	NO CONNECTION	16	NC	NO CONNECTION	17	NC	NO CONNECTION	18	NC	NO CONNECTION	19	NC	NO CONNECTION	20	NC	NO CONNECTION	21	NC	NO CONNECTION	22	NC	NO CONNECTION	23	NC	NO CONNECTION	24	GND	Ground	25	HTPDN	Hot plug detect	26	LOCKN	Lock detect	
Pin	Name	Description																																																
12	GND	Ground																																																
13	GND	Ground																																																
14	GND	Ground																																																
15	NC	NO CONNECTION																																																
16	NC	NO CONNECTION																																																
17	NC	NO CONNECTION																																																
18	NC	NO CONNECTION																																																
19	NC	NO CONNECTION																																																
20	NC	NO CONNECTION																																																
21	NC	NO CONNECTION																																																
22	NC	NO CONNECTION																																																
23	NC	NO CONNECTION																																																
24	GND	Ground																																																
25	HTPDN	Hot plug detect																																																
26	LOCKN	Lock detect																																																
JC3	Factory use	Default open																																																
JP1	Panel I2C SCL	Connected with jumper to enable I2C path to panel																																																
JP2	Panel I2C SDA	Connected with jumper to enable I2C path to panel																																																
JP6	Input power control	Short = External switch control and fix the board ON Open = Switch mount control																																																
JP7	Factory use	Default connected with jumpers at 1-2 and 3-4																																																
JP11	Panel output power pin selection on J7	See panel output power pin selection table 2																																																
JP12	Panel output power pin selection on J7	See panel output power pin selection table 2																																																
SW3	Panel & function selection	See table 3																																																

Table 1 : Panel voltage setting table (JA3, JA7, JA8 and JA9) :

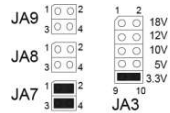
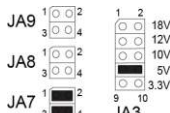
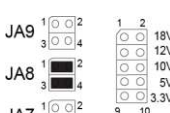



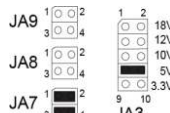
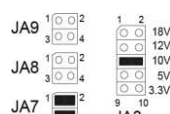
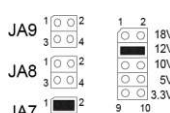
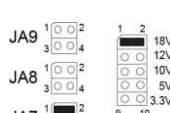







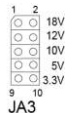



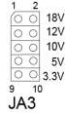



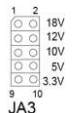

Input voltage via PP2/PP5	Panel Voltage	JA3	JA7	JA8	JA9	Jumper on board
12VDC	3.3V	3V3 closed	1-2 & 3-4	OPEN	OPEN	
	5V	5V closed	1-2 & 3-4	OPEN	OPEN	
	12V	DON'T CARE	OPEN	1-2 & 3-4	OPEN	

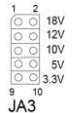
CAUTION: Incorrect setting can damage panel & controller

Input voltage via PP2/PP5	Panel Voltage	JA3	JA7	JA8	JA9	Jumper on board
24VDC**	3.3V	3V3 closed	1-2 & 3-4	OPEN	OPEN	
	5V	5V closed	1-2 & 3-4	OPEN	OPEN	
	10V	10V closed	1-2 & 3-4	OPEN	OPEN	
	12V	12V closed	1-2 & 3-4	OPEN	OPEN	
	18V	18V closed	1-2 & 3-4	OPEN	OPEN	

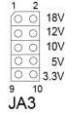
CAUTION: Incorrect setting can damage panel & controller

**** Ensure that the backlight inverter supports 24V operation prior to connecting a 24VDC input. Because CNA1 pin 1 and CNB1 pin 2 will output 24VDC if input 24VDC via PP5 or PP2.**

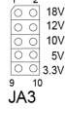
Input voltage via PP4*	Input voltage via PP2 / PP5	Panel Voltage	JA3	JA7	JA8	JA9	Jumper on board
3.3V	12V / 24VDC	3.3V	DON'T CARE	OPEN	OPEN	1-2 & 3-4	   
5V		5V	DON'T CARE	OPEN	OPEN	1-2 & 3-4	   
10V		10V	DON'T CARE	OPEN	OPEN	1-2 & 3-4	   
12V		12V	DON'T CARE	OPEN	OPEN	1-2 & 3-4	   
18V		18V	DON'T CARE	OPEN	OPEN	1-2 & 3-4	   
24V		24V	DON'T CARE	OPEN	OPEN	1-2 & 3-4	   

* Maximum current for 3.3V, 5V = 7A, Maximum current for 10V, 12V = 5A, Maximum current for 18V, 24V = 3.5A

(Please pay attention to the jumper settings on JA3, JA7, JA8 & JA9 which are red in color)

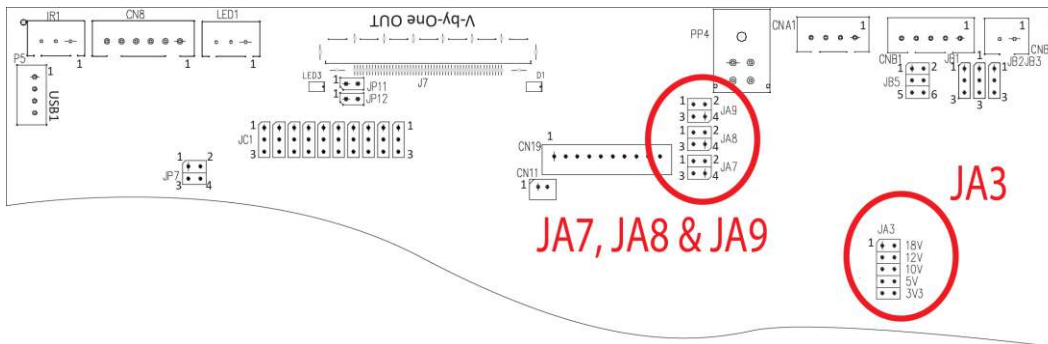

Table 2 : Panel Output power pin selection table (JP11 and JP12):

Output power pin selection on J7	JP11	JP12	Jumper on board
Pin-44 to Pin-51 (Pin-1 to Pin-8)*	1-2 CLOSE	1-2 CLOSE	2 JP11 2 JP12
Pin-48 to Pin-51 (Pin-1 to Pin-4)*	1-2 CLOSE	1-2 OPEN	2 JP11 2 JP12
Pin-44 to Pin-47 (Pin-5 to Pin-8)*	1-2 OPEN	1-2 CLOSE	2 JP11 2 JP12
No power output on pins	1-2 OPEN	1-2 OPEN	2 JP11 2 JP12

CAUTION: Incorrect setting can damage panel & controller

*Pin # read at panel side

Table 3 : Panel timing selection (SW3)

Pos #1	Pos #2	Pos #3	Pos #4	Description	Panel resolution
OFF	OFF	OFF	OFF	IE-2000 (120Hz FRC)	3840 x 2160
OFF	OFF	OFF	OFF	V-by-One panel	3840 x 2160
Others combination				Reserved	

Pos. #	Function	Description
5	Panel display division	OFF: no division ON: 2 divisions
6	Output display bit mode selection	OFF: 10-bit ON: 8-bit
7	Reserved	OFF (factory default)
8	Reserved	OFF (factory default)

CN4 - HDMI3 connector : JST BM20B-SRDS (Matching type : SHDR-20V-S-B)

PIN	SYMBOL	DESCRIPTION
1	GND	Ground
2	GND	Ground
3	RXC+	TMDS Data C+
4	RXC-	TMDS Data C-
5	RX0+	TMDS Data 0+
6	RX0-	TMDS Data 0-
7	RX1+	TMDS Data 1+
8	RX1-	TMDS Data 1-
9	RX2+	TMDS Data 2+
10	RX2-	TMDS Data 2-
11	GND	Ground
12	GND	Ground
13	M_SCL	Reserved
14	M_SDA	Reserved
15	DDC_5V	+5V power supply for DDC (optional)
16	HPD	Hot plug detection
17	DDC_SCL	DDC serial clock
18	DDC_SDA	DDC Data
19	NC	Reserved
20	VCC	+5V

CN6 – Alternate DVI connector: JST BM20B-SRDS (Matching type : SHDR-20V-S-B)

PIN	SYMBOL	DESCRIPTION
1	GND	Digital Ground
2	GND	Digital Ground
3	RXC	TMDS Clock+
4	/RXC	TMDS Clock-
5	RX0	TMDS Data 0+
6	/RX0	TMDS Data 0-
7	RX1	TMDS Data 1+
8	/RX1	TMDS Data 1-
9	RX2	TMDS Data 2+
10	/RX2	TMDS Data 2-
11	GND	Ground (+5, Analog H/V Sync)
12	GND	Digital Ground
13	M_SCL	Reserved
14	M_SDA	Reserved
15	DDC_5V	+5V power supply for DDC (optional)
16	HPD	Hot plug detect
17	DDC_CLK	DDC Clock
18	DDC_DAT	DDC Data
19	NC	No connection
20	VCC	+5V

CN7 - Audio board connector : 2x5 right angled header (Matching audio add-on board P/N 416940020-3 & Audio extend cable P/N 426009700-3)

PIN	SYMBOL	DESCRIPTION
1	VCC	Audio board logic power supply, +5V
2	VOLSEL0	Reserved
3	VOLSEL1	Reversed
4	TUNAUSEL	Reserved
5	CLK/CNT	Reserved
6	GND	Ground
7	+12V/+24V	Audio board power supply, +12V/+24V
8	NC	No connection
9	NC	No connection
10	GND	Ground

CN8 – RS-232 serial control: JST B6B-XH-A (Matching type : XHP-6)

PIN	SYMBOL	DESCRIPTION
1	M_SCL	Reserved
2	M_SDA	Reserved

3	VCC	+5V
4	TXD	RS-232 Tx data
5	GND	Ground
6	RXD	RS-232 Rx data

CN9 – Ambient light sensor connector : JST B3B-PH-K (Matching type : PHR-3)

PIN	SYMBOL	DESCRIPTION
1	GND	Ground
2	VCC_5V	VCC 5V
3	ALSF	Ambient light sensing feedback

CN11 – SPDIF audio output connector : JST B2B-ZR (Matching type : ZHR-2)

PIN	SYMBOL	DESCRIPTION
1	SPDIF	SPDIF Digital audio output
2	GND	Ground

CN13 - Audio line in: JST B4B-ZR (Matching type : ZHR-4)

PIN	SYMBOL	DESCRIPTION
1	GND	Ground
2	LINE_IN_L	Line in (Left)
3	GND	Ground
4	LINE_IN_R	Line in (Right)

CN14 - Audio line out: JST B4B-ZR (Matching type : ZHR-4)

PIN	SYMBOL	DESCRIPTION
1	GND	Ground
2	AUDIO_OUT_L	Audio out (Left)
3	GND	Ground
4	AUDIO_OUT_R	Audio out (Right)

CN15 - Power connector for IE2000

PIN	SYMBOL	DESCRIPTION
1	12/24VA	+12/24 VDC
2	12/24VA	+12/24 VDC
3	GND	Ground
4	GND	Ground

CN19 – Additional panel power output : JST B10B-PH-K (Matching type : PHR-10)

PIN	SYMBOL	DESCRIPTION
1	PVLCD_VCC	Panel power supply (selected by JA3, JA7, JA8 & JA9)
2	PVLCD_VCC	Panel power supply (selected by JA3, JA7, JA8 & JA9)
3	PVLCD_VCC	Panel power supply (selected by JA3, JA7, JA8 & JA9)
4	PVLCD_VCC	Panel power supply (selected by JA3, JA7, JA8 & JA9)
5	PVLCD_VCC	Panel power supply (selected by JA3, JA7, JA8 & JA9)
6	GND	Ground
7	GND	Ground
8	GND	Ground
9	GND	Ground
10	GND	Ground

CNA1 - Auxiliary power output: JST B4B-XH-A (Matching type : XHP-4)

PIN	SYMBOL	DESCRIPTION
1	AUX 12V / 24V	+12V / +24V DC
2	GND	Ground
3	GND	Ground
4	AUX 5V	+5V DC, 500mA max

CNB1 – Backlight inverter connector: JST B5B-XH-A (Matching type : XHP-5)

PIN	SYMBOL	DESCRIPTION
1	GND	Ground
2	VBKL	+12V / +24V DC, backlight power supply
3	BLCTRL	On/Off control (enable) – see JB2 & JB3
4	BVR_WIP	Brightness VR – WIP
5	BVR_A	Brightness VR A

CNB2 – Backlight status input inverter connector: JST B2B-XH-A (Matching type : XHP-2)

PIN	SYMBOL	DESCRIPTION
1	BL_STATUS	Backlight status (Normal = High)
2	GND	Ground

CNC1 – OSD switch mount control, Hirose DF13A-12P-1.25H (Mating type : DF13-12S-1.25C)

PIN	SYMBOL	DESCRIPTION
1	PSWIN	Power button A
2	SW_ON	Power button B
3	BVR_A	Backlight Brightness VR pin A
4	BVR_WIP	Backlight Brightness R pin WIP
5	BVR_B	Backlight Brightness VR pin B (470 ohm resistor to +5V Vcc)
6	GND	Ground
7	MENU	OSD menu
8	-/LEFT	OSD -/Left
9	+ /RIGHT	OSD +/Right
10	SEL_DN	OSD Select down
11	SEL_UP	OSD Select up
12	NC	No connection

The VR for brightness depends on the inverter. The main power load for On/Off is handled by a relay on the controller.

IR1 – Infra-Red sensor connector: JST B3B-XH-A (Matching type : XHP-3)

PIN	SYMBOL	DESCRIPTION
1	GND	Ground
2	VCC	+3.3V
3	IR Data	IR data

J7 – V-by-One panel signal output connector: JAE FI-RE51S-HF (Matching type : JAE FI-RE51HL)

PIN	SYMBOL	DESCRIPTION
1	(51) GND	Ground
2	(50) VB1_TX7P	V-by-One HS Data Lane 7
3	(49) VB1_TX7N	V-by-One HS Data Lane 7
4	(48) GND	Ground
5	(47) VB1_TX6P	V-by-One HS Data Lane 6
6	(46) VB1_TX6N	V-by-One HS Data Lane 6
7	(45) GND	Ground
8	(44) VB1_TX5P	V-by-One HS Data Lane 5
9	(43) VB1_TX5N	V-by-One HS Data Lane 5
10	(42) GND	Ground
11	(41) VB1_TX4P	V-by-One HS Data Lane 4
12	(40) VB1_TX4N	V-by-One HS Data Lane 4
13	(39) GND	Ground
14	(38) VB1_TX3P	V-by-One HS Data Lane 3
15	(37) VB1_TX3N	V-by-One HS Data Lane 3
16	(36) GND	Ground
17	(35) VB1_TX2P	V-by-One HS Data Lane 2
18	(34) VB1_TX2N	V-by-One HS Data Lane 2
19	(33) GND	Ground
20	(32) VB1_TX1P	V-by-One HS Data Lane 1
21	(31) VB1_TX1N	V-by-One HS Data Lane 1
22	(30) GND	Ground
23	(29) VB1_TX0P	V-by-One HS Data Lane 0
24	(28) VB1_TX0N	V-by-One HS Data Lane 0
25	(27) GND	Ground
26	(26) LOCKN	V-by-One LOCK
27	(25) HTPDN	V-by-One HTPDN
28	(24) OP10	High/Low state control
29	(23) OP9	High/Low state control
30	(22) OP8	High/Low state control
31	(21) OP7	High/Low state control
32	(20) OP6	High/Low state control
33	(19) OP5 / PANEL_SCL	High/Low state control / Panel I ² C SCL
34	(18) OP4 / PANEL_SDA	High/Low state control / Panel I ² C SDA
35	(17) OP3	High/Low state control
36	(16) OP2	High/Low state control
37	(15) OP1	High/Low state control
38	(14) GND	Ground
39	(13) GND	Ground
40	(12) GND	Ground
41	(11) GND	Ground
42	(10) GND	Ground

Specifications subject to change without notice

43	(9)	NC	No Connection
44	(8)	PVLCD_VCC	Panel power supply (enabled by JP12 jumper)
45	(7)	PVLCD_VCC	Panel power supply (enabled by JP12 jumper)
46	(6)	PVLCD_VCC	Panel power supply (enabled by JP12 jumper)
47	(5)	PVLCD_VCC	Panel power supply (enabled by JP12 jumper)
48	(4)	PVLCD_VCC	Panel power supply (enabled by JP11 jumper)
49	(3)	PVLCD_VCC	Panel power supply (enabled by JP11 jumper)
50	(2)	PVLCD_VCC	Panel power supply (enabled by JP11 jumper)
51	(1)	PVLCD_VCC	Panel power supply (enabled by JP11 jumper)

(1) - (51): Pin# read on panel side.

LED1 – Status LED connector: 3-pin header

PIN	DESCRIPTION
1	Green LED pin (anode)
2	LED pin common (cathode)
3	Red LED pin (anode)

P1 – DVI-I (Single link) in

PIN	SYMBOL	DESCRIPTION
1	/RX2	TMDS Data 2-
2	RX2	TMDS Data 2+
3	GND	Digital Ground
4	NC	No connection
5	NC	No connection
6	DDC_CLK	DDC Clock
7	DDC_DAT	DDC Data
8	VS_IN	Analog Vertical Sync
9	/RX1	TMDS Data 1-
10	RX1	TMDS Data 1+
11	GND	Digital Ground
12	NC	No connection
13	NC	No connection
14	DDC_5V	+5V power supply for DDC (optional)
15	GND	Ground
16	HPD	Hot Plug Detect
17	/RX0	TMDS Data 0-
18	RX0	TMDS Data 0+
19	GND	Digital Ground
20	NC	No connection
21	NC	No connection
22	GND	Digital Ground
23	RXC	TMDS Clock+
24	/RXC	TMDS Clock-
C1	RIN	Analog Red
C2	GIN	Analog Green
C3	BIN	Analog Blue
C4	HS_IN	Analog horizontal sync
C5	GND	Ground
C6	NC	No connection

P2 – HDMI1 (HDMI 2.0) connector

PIN	SYMBOL	DESCRIPTION
1	DATA2+	TMDS Data2+
2	DATA2S	TMDS Data2 Shield
3	DATA2-	TMDS Data2-
4	DATA1+	TMDS Data1+
5	DATA1S	TMDS Data1 Shield
6	DATA1-	TMDS Data1-
7	DATA0+	TMDS Data0+
8	DATA0S	TMDS Data0 Shield
9	DATA0-	TMDS Data0-
10	CLK+	TMDS Clock+
11	CLK@	TMDS Clock Shield
12	CLK-	TMDS Clock-
13	NC	Reserved
14	NC	Reserved
15	SCL	SCL (I ² C Serial Clock for DDC)
16	SDA	SDA (I ² C Serial Data Line for DDC)
17	GND	Ground
18	+5V	HDMI +5 V power
19	HPDET	Hot Plug Detect

Specifications subject to change without notice

P3 - HDMI2 (HDMI2.0) connector

PIN	SYMBOL	DESCRIPTION
1	DATA2+	TMDS Data2+
2	DATA2S	TMDS Data2 Shield
3	DATA2-	TMDS Data2-
4	DATA1+	TMDS Data1+
5	DATA1S	TMDS Data1 Shield
6	DATA1-	TMDS Data1-
7	DATA0+	TMDS Data0+
8	DATA0S	TMDS Data0 Shield
9	DATA0-	TMDS Data0-
10	CLK+	TMDS Clock+
11	CLK@	TMDS Clock Shield
12	CLK-	TMDS Clock-
13	NC	Reserved
14	NC	No connection
15	SCL	SCL (I ² C Serial Clock for DDC)
16	SDA	SDA (I ² C Serial Data Line for DDC)
17	GND	Ground
18	+5V	HDMI +5 V Power
19	HPDET	Hot Plug Detect

P5 - USB1 connector

PIN	SYMBOL	DESCRIPTION
1	+5V	USB +5V power (max 500mA)
2	DATA-	USB differential data minus
3	DATA+	USB differential data plus
4	GND	Ground

P6 - USB2 connector

PIN	SYMBOL	DESCRIPTION
1	+5V	USB +5V power (max 500mA)
2	DATA-	USB differential data minus
3	DATA+	USB differential data plus
4	GND	Ground

PP2 - Alternate 12V/24VDC input power: Molex 2 pin 0.156" pitch

PIN	DESCRIPTION
1	+12VDC / 24VDC in
2	Ground

PP4 - External panel power input: Molex 43045-0400 or compatible (Matching type : Molex 43025-0400 or compatible)

PIN	DESCRIPTION
1	External panel power
2	Ground
3	External panel power
4	Ground

PP5 - 12V/24VDC input power: Molex 43045-0400 or compatible (Matching type : Molex 43025-0400 or compatible)

PIN	DESCRIPTION
1	+12VDC / 24VDC in
2	Ground
3	+12VDC / 24VDC in
4	Ground

CONTROLLER DIMENSIONS

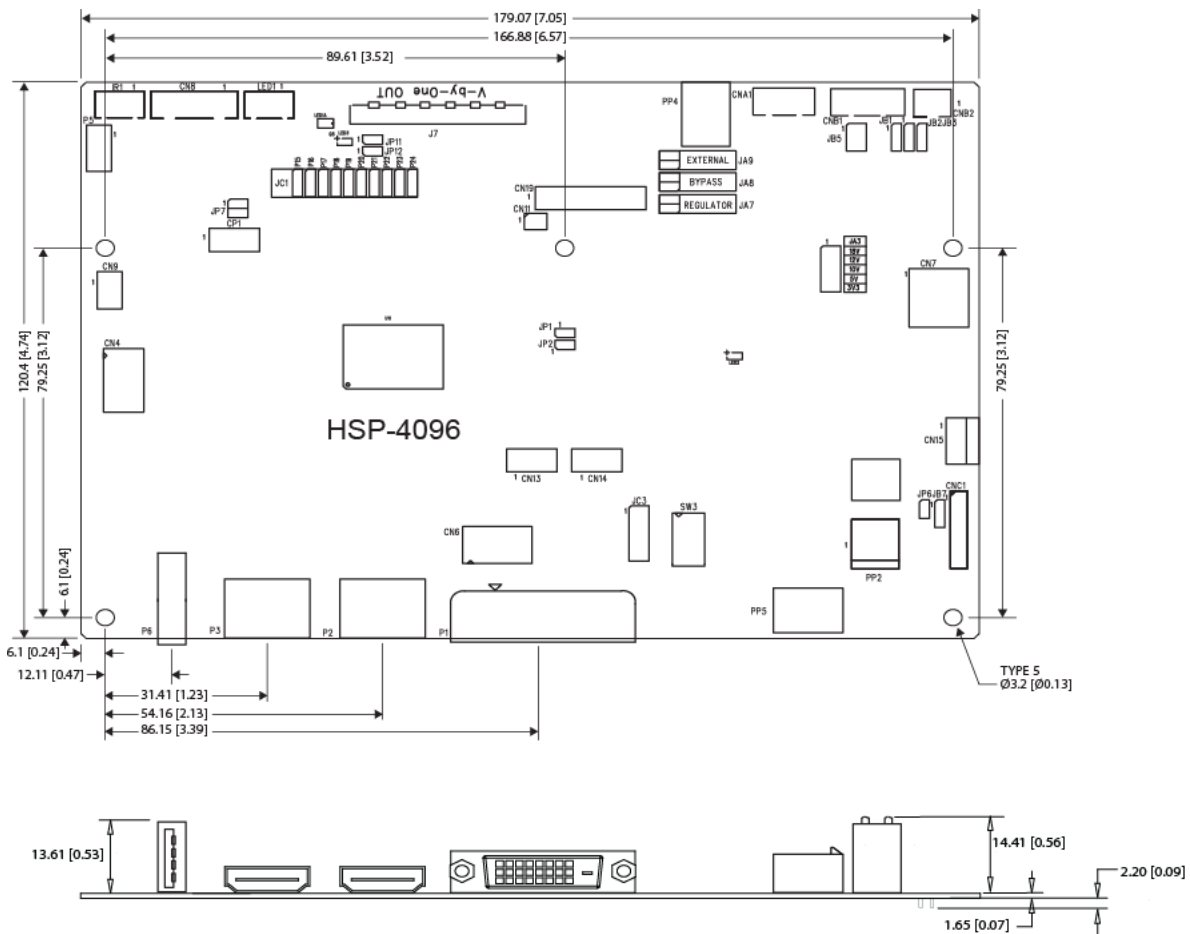

Ready-made 3D Pro-E (SLDPRT) drawing files - Save time and effort for your system volumetric analysis design. Includes jpg file previews. Please go to download at <http://www.digitalview.com/products/HSP-4096-lcd-controller>

The maximum thickness of the controller is 18.93mm with or without video add-on board (measured from bottom of PCB to top of components, including any underside components & leads). We recommend clearances of:

- 5mm from bottom of PCB - if mounting on a metal plate we also recommend a layer of suitable insulation material is added to the mounting plate surface.
- 10mm above the components
- 3~5mm around the edges

Any of the holes shown above can be used for mounting the PCB, they are 3.2mm in diameter.

CAUTION: Ensure adequate insulation is provided for all areas of the PCB with special attention to high voltage parts such as the inverter.

APPLICATION NOTES

USING THE CONTROLLER WITHOUT BUTTONS ATTACHED

This is very straightforward:

- Firstly setup the controller/display system with the buttons. With controls attached and display system active make any settings for color, tint and image position as required then switch everything off.
- Remove the control switches, the 12-way (CNC1) cable.
- Use a jumper or similar to connect pins 1 & 2 on JP6, this will fix the board On.
- Refer to inverter specifications for details as to fixing brightness to a desired level, this may require a resistor, an open circuit or closed circuit depending on inverter.

Summary: On CNC1 the only pins that are used are for On/Off and Brightness (if controller mounted inverter is used). On CNC1 the pins are for momentary type buttons so it doesn't matter that no buttons are attached.

INVERTER CONNECTION

There are potentially 3 issues to consider with inverter connection:

- Power
- Enable
- Brightness

Please read the following sections for a guide to these issues.

Inverter Power: As per the table for CNB1 pin 1 is ground and pin 2 provides 12V/24V DC. This should be matched with the inverter specification: see table.

CNB1

PIN	DESCRIPTION
1	Ground
2	+12V/+24VDC

Remark: For higher power inverter, more current (for 12V/24V) can be taken from CNA1 pin 1.

Enable: This is a pin provided on some inverters for On/Off function and is used by this panel controller for VESA DPMS compliance. If the inverter does not have an enable pin or the enable pin is not used then DPMS will not be operational. Pin 3 should be matched to the inverters specification for the 'enable' or 'disable' pin.

CNB1

PIN	DESCRIPTION
3	Enable

Further, jumpers JB2 & JB3 should be set to match the inverters specification for the enable pin power and High or Low setting: see table.

Ref	Purpose	Note
JB2	Inverter enable voltage	1-2 H = 3.3V, 2-3 H = 5V, OPEN H = open collector
JB3	Inverter control	1-2 H = On, 2-3 L = On

Brightness: There are various methods for brightness control and it is important to consider the specifications for the inverter to be used. Generally the situation is:

- Brightness can control by using a resistor or VR (Variable Resistor).
- Brightness controlled by adding a circuit such as PWM (Pulse Width Modulation).
- No adjustment of brightness is possible.

CNB1 pins 4 & 5 are available for connecting to an inverter or circuit where VR control is supported.

CNB1

PIN	DESCRIPTION
4	VR WIP
5	VR A

This can then be matched with function controls connected to CNC1 pins 4 & 3 or 5: see table.

CNC1

PIN	DESCRIPTION
3	VR A
4	VR WIP
5	VR B

Design Guideline for making VR circuitry :

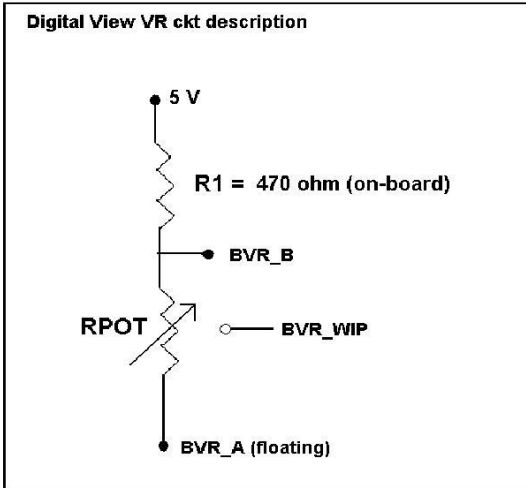

Signal description / Notes :

- 1) R1 : 470ohm on board
- 2) RPOT is an external potentiometer (in-line dip style) that can be plugged directly into CNC1 pins 3,4,5. RPOT must be supplied / installed by user.
- 3) BVR_B : Voltage tapped from “top” of potentiometer, the node of R1 and RPOT.
- 4) BVR_WIP : Voltage tapped from wiper arm of RPOT.
- 5) BVR_A : Voltage tapped from “bottom” of RPOT.

Note : BVR_A voltage is left floating on the controller board. To use this circuit, you need to tie this point to a potential (usually GND, available at CNC1 pin 6).

CNB1 – Backlight inverter connector: JST B5B-XH-A (Matching type : XHP-5)

PIN	SYMBOL	DESCRIPTION
1	GND	Ground
2	VBKL	+12V/24VDC, backlight power supply
3	BLCTRL	On/Off control (enable) – see JB2 & JB3
4	BVR_WIP	Brightness VR - WIP
5	BVR_A	Brightness VR A

CNC1 – OSD switch mount control, Hirose DF13A-12P-1.25H (Mating type : DF13-12S-1.25C)

PIN	SYMBOL	DESCRIPTION
1	PSWIN	Power button A
2	SW_ON	Power button B
3	BVR_A	Backlight Brightness VR pin A
4	BVR_WIP	Backlight Brightness R pin WIP
5	BVR_B	Backlight Brightness VR pin B (470 ohm resistor to +5V Vcc)
6	GND	Ground
7	MENU	OSD menu
8	-/LEFT	OSD -/Left
9	+/RIGHT	OSD +/Right
10	SEL_DN	OSD Select down
11	SEL_UP	OSD Select up
12	NC	No connection

The VR for brightness depends on the inverter. The main power load for On/Off is handled by a relay on the controller.

Example for circuit design :

- 1.) Choose RPOT = 10K
- 2.) Tie BVR_A to GND
- 3.) Circuit analysis gives BVR_WIP as the following (see Figure 1)

$$BVR_WIP = 5 \times (Rbc/10.47)$$

where BVR_WIP is in Volts.
And Rbc is the resistance from the wiper arm to bottom of pot in Kohms.

To evaluate, plug in different values of Rbc :

Rbc	BVR_WIP
0	0 V
2.5 K	1.2 V
5 K	2.4 V
7.5 K	3.6 V
10 K	4.8 V

So this circuit could provide Brightness adjust voltage ranging from 0V to 5V.

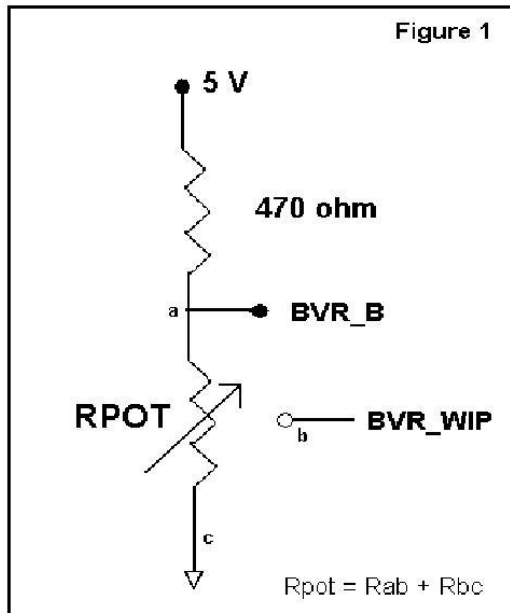

TROUBLESHOOTING

General

A general guide to troubleshooting a flat panel display system it is worth considering the system as separate elements, such as:

- Controller (jumpers, PC settings)
- Panel (controller, cabling, connection, panel, PC settings)
- Backlight (inverter, cabling, backlight tubes)
- Cabling
- Computer system (display settings, operating system)

Through step by step cross checking with instruction manuals and a process of elimination to isolate the problem it is usually possible to clearly identify the problem area.

No image:

- If the panel backlight is not working it may still be possible to just see some image on the display.
- A lack of image is most likely to be caused by incorrect connection, lack of power, failure to provide a signal or incorrect graphic card settings.

Image position:

If it is impossible to position the image correctly, i.e. the image adjustment controls will not move the image far enough, then test using another graphics card. This situation can occur with a custom graphics card that is not close to standard timings or if something is in the graphics line that may be affecting the signal such as a signal splitter (please note that normally a signal splitter will not have any adverse effect).

Image appearance:

- A faulty panel can have blank lines, failed sections, flickering or flashing display
- Incorrect graphics card refresh rate, resolution or interlaced mode will probably cause the image to be the wrong size, to scroll, flicker badly or possibly even no image.
- Incorrect jumper settings on the controller may cause everything from total failure to incorrect image. CAUTION: Do not set the panel power input incorrectly.
- Sparkling on the display: faulty panel signal cable.

Backlight:

Items to check include: Power input, Controls, Inverter and Tubes generally in this order.

If half the screen is dimmer than the other half:

- Check cabling for the inverter.
- For a specific backlight tube check the AC pins orientation (CAUTION: Never reverse any DC power pins).

Also:

- If adjusting brightness control has no effect the chances are that the VR rating or method of adjusting brightness is not compatible or correctly connected to the inverter.
- If system does not power down when there is a loss of signal

Continued failure:

If unit after unit keeps failing consider and investigate whether you are short circuiting the equipment or doing something else seriously wrong.

Generally after common sense issues have been resolved we recommend step by step substitution of known working parts to isolate the problem.

The following are some of LED indicators onboard that can help to know the health status of the controller board:

LED1A

- Green : Valid video signal received on the selected input port.
- Red : (1) No video signal received on the selected input port. (2) Soft power off.
- Green + Red : The board is fail to boot up. Suggest to send it back to factory for check.
- Off : The board is not powered on.

LED3

- Red : Panel power is supplied to panel.
- Off : No power is supplied to panel.

D1

- Green : V-by-One's signal is detected and locked.
- Off : No V-by-One's signal is detected and locked.

SPECIFICATIONS

Panel compatibility	Compatible with 4096x2160 and 3840x2160 resolutions of TFT LCD panels with V-by-One panel interface. A specified BIOS and some factory adjustment is required for individual panel timings.
No. of colors	Up to 3 x 10 bit providing 1.06 billion colors.
Panel power	DC 3.3V, 5V, 10V, 12V, 18V
Panel signal	V-by-One (8 Lane)
Video inputs	DVI-I (Single Link) x 1 HDMI 1.4 x 1 HDMI 2.0 x 2
Functions display	On screen display (OSD) of functions
Media format (Failover playback)	.MP4 (H.264)
OSD menu functions	Image controls: Contrast, Black level, Sharpness, Hue, Saturation, Color temperature. Other features: Image position, Clock, Phase, Auto Picture Setup, Aspect/Size, Backlight brightness adjustment, Input source select, Auto Color Gain, OSD menu transparency, OSD time out, Reset to Factory Defaults, Image orientation, Software update(USB), Auto Source Seek, Failover, Backlight Invert, Backlight control (D/A or PWM), Backlight Frequency, Minimum backlight level adjustment, Volume control.
OSD menu controls available	Power On/Off OSD Menu OSD Select up OSD Select down Setting + Setting -
Control interface	Buttons, RS-232, IR Remote control
Audio	Digital audio line out (from header) with OSD volume control. (not amplified)
Settings memory	Settings are stored in non volatile memory
PC Connectivity	VGA / SVGA / XGA / SXGA / UXGA / WUXGA / 4K UHD analog or digital
Controller dimensions	179.07mm x 120.4mm (7.05" x 4.74")
Power consumption	10W approx. (not including panel power consumption)
Power load maximum	The controller has an overall 3A current limit.
Input voltage	12V/24VDC +/- 5%
Power protection	Fuse fitted (Resettable)
Storage temperature limits	-40°C to +70°C
Operating temperature limits	-20°C to +80°C
Use of memory on board	- 1 pc SRAM - MCU & RAM (MSD91H0BN2) on U11, 128MBytes which is a volatile memory : SRAM for OSD and RAM for frame buffer. - 1 pc Flash - (GD25Q64) on U4, 64Mbits which is a non-volatile memory for system program. - 4 pcs EEPROM - (24C02) on U8,U19,U20 & U21, 2Kbits which is a non-volatile memory for EDID. - 1 pc EEPROM- (24C128C) on U14, 128Kbits which is a non-volatile memory for System Setting Storage.

NOTES

Please note the following:

- For specific panel setup a sample of an LCD may be required (this will be returned) and a copy of the full technical specifications for the panel from the manufacturer.
- Re-layout and custom development services are available.

Appendix I – Signal support mode table

ARGB input port (P1) : (with DVI to VGA adapter)

Resolution
640x480 60Hz
640x480 75Hz
800x600 56Hz
800x600 60Hz
800x600 72Hz
800x600 75Hz
1024x768 60Hz
1024x768 70Hz
1024x768 75Hz
1280x768 60Hz
1280x768 75Hz
1280x1024 60Hz
1280x1024 75Hz
1360x768 60Hz
1440x900 60Hz
1440x900 75Hz
1600x1200 60Hz
1680x1050 60Hz
1920x1080 60Hz
1920x1200 60Hz

DVI input port (P1) :

Resolution
640x480 60Hz
640x480 75Hz
800x600 56Hz
800x600 60Hz
800x600 72Hz
800x600 75Hz
1024x768 60Hz
1024x768 70Hz
1024x768 75Hz
1280x768 75Hz
1280x800 75Hz
1280x1024 60Hz
1280x1024 75Hz
1360x768 60Hz
1366x768 60Hz
1440x900 75Hz
1600x1200 75Hz
1680x1050 75Hz
1920x1080 60Hz
1920x1200 60Hz

HDMI 3 input port (CN4) : (HDMI 1.4)

Resolution
640x480 60Hz
640x480 72Hz
640x480 75Hz
800x600 56Hz
800x600 60Hz
800x600 72Hz
800x600 75Hz
1024x768 60Hz
1024x768 70Hz
1024x768 75Hz
1280x768 60Hz
1280x768 75Hz
1280x800 60Hz
1280x800 75Hz
1280x1024 60Hz
1280x1024 75Hz
1360x768 60Hz
1366x768 60Hz
1440x900 60Hz
1440x900 75Hz
1600x1200 60Hz
1680x1050 60Hz
1680x1050 75Hz
1920x1080 60Hz
1920x1200 60Hz
2560x1600 60Hz
3840x2160 30Hz

HDMI 1 and HDMI 2 input port (P2 and P3) : (HDMI 2.0)

Resolution
640x480 60Hz
640x480 72Hz
640x480 75Hz
800x600 56Hz
800x600 60Hz
800x600 72Hz
800x600 75Hz
1024x768 60Hz
1024x768 70Hz
1024x768 75Hz
1280x768 60Hz
1280x768 75Hz
1280x800 60Hz
1280x800 75Hz
1280x1024 60Hz
1280x1024 75Hz
1360x768 60Hz
1366x768 60Hz
1440x900 60Hz
1440x900 75Hz
1600x1200 60Hz
1680x1050 60Hz
1680x1050 75Hz
1920x1080 60Hz
1920x1200 60Hz
2560x1600 60Hz
3840x2160 30Hz
3840x2160 60Hz
4096x2160 60Hz

Appendix II – RS-232 control protocols and command set

RS-232 Serial control (Baud rate 9600), 8 bits, 1 stop bit and no parity

Physical connection :

Controller side
Connector interface : CN8
Mating connector : JST XHP-6

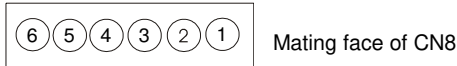

PIN#	Description
4	RS-232 Tx Data
5	Ground
6	RS-232 Rx Data

Computer side
Connector interface : Serial port
Mating connector : DB9 Female

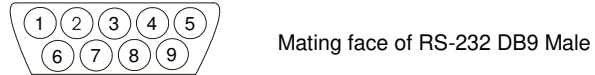

PIN#	Description
2	RS-232 Rx Data
3	RS-232 Tx Data
5	Ground

Remark :

(1) : RS-232 connection cable, 600mm P/N 426090200-3 can be ordered separately for connection.

Software connection :

The OSD function can be controlled through sending the RS-232 protocol.

The RS-232 program can be custom-made to fit for application or it can be used the serial control program, like Accessport, Telix or Serial Utility program developed by DigitalView. Please contact your local support for information.

1. Commands to implement switch mount control buttons

Function	Command	Description	Remark
Menu button	0xf7	Menu button pressed	Button equivalent
Select-down button	0xfa	Select-down button pressed	Button equivalent
Select-up button	0xfb	Select-up button pressed	Button equivalent
Right/+ button	0xfc	Right/+ button pressed	Button equivalent
Left/- button	0xfd	Left/- button pressed	Button equivalent

2. Parameter setting - immediate, relative, reset and query

Function	Command	Description	Acknowledge (if enabled)
Volume control - left+right channel	0x80, "a" "A", nn "+" "-" "r" "R" "?"	Set audio (L+R) volume = value/increment/decrement Reset Query	nn = "0"~"4" (hex of 0~100) Default: "3"~"2" (hex of 50)
Volume control - on/off (mute)	0x80, "m" "M", "0" "1" "r" "R" "?"	Disable audio output. Enable audio output. Reset Query	"0" - audio off (muted). "1" - audio on.
Backlevel control (Brightness)	0x81, nn "+" "-" "r" "R" "?" "m" "n" "i", ss, nn "o", ss,	Set brightness = value/increment/decrement Reset Query Current Source Maximum query Minimum query Set, Source, Value Query, Source	nn = "0"~"4" (hex of 0~100) Default: "3"~"2" (hex of 50) Return current source black level value ss - reference by Input Source Select(0x98) Return query source black level value
Contrast control - all channels	0x82, "a" "A", nn "+" "-" "r" "R" "?" "m" "n" "i", ss, nn "o", ss,	Set all contrast = value/increment/decrement Reset Query Maximum query Minimum query Set, Source, value Query, Source	nn = "0"~"4" (hex of 0~100) Default: "3"~"2" (hex of 50) Return current source contrast value ss - reference by Input main select(0x98)
Color Saturation control	0x83, nn "+" "-" "r" "R" "?" "m" "n" "i", ss, nn "o", ss,	Set color = value/increment/decrement Reset Query Maximum query Minimum query Set, Source, value Query, Source	nn = "0"~"4" (hex of 0~100) Default: "3"~"2" (hex of 50) Return current source saturation value ss - reference by Input main select(0x98)
Hue control	0x84, nn "+" "-" "r" "R" "?" "m" "n" "i", ss, nn "o", ss,	Set tint = value/increment/decrement Reset Query Maximum query Minimum query Set, Source, value Query, Source	nn = "0"~"4" (hex of 0~100) Default: "3"~"2" (hex of 50) Return current source hue value ss - reference by Input main select(0x98)
Phase control (only for VGA port)	0x85, nn "+" "-" "?"	Set dot clock phase = value/increment/decrement Query	nn = "0"~"4" (hex of 0~100)
Image H position (only for VGA port)	0x86, nn "+" "-" "r" "R" "?"	Set horizontal position = value/increment/decrement Reset Query	nn = "0"~"4" (hex of 0~100) Default: "3"~"2" (hex of 50)
Image V position (only for VGA port)	0x87, nn "+" "-" "r" "R" "?"	Set vertical position = value/increment/decrement Reset Query	nn = "0"~"4" (hex of 0~100) Default: "3"~"2" (hex of 50)
Sharpness (not available for VGA port)	0x8a, nn "+" "-" "r" "R"	Set sharpness = value/increment/decrement Reset	nn = "0"~"4" (hex of 0~100) Default: "3"~"2" (hex of 50)

Specifications subject to change without notice

	"?" "m" "n" "i", ss, nn "o", ss,	Query current source Maximum query Minimum query Set, Source, Value Query, Source	Return current source sharpness value ss - reference by Input Source Select(0x98) Return query source sharpness value
Clock control (only for VGA port)	0x8b, nn "+" "-" "?"	Set VGA clock= Value/increment/decrement Query	nn = "0"~"4"~"6"~"4" (hex of 0~100)
Aspect ratio	0x8c, "0" "1" "9" "A" "r" "R" "?"	Set display orientation = value Reset Query	"0" – 1:1 "1" – fill screen (Default) "9" – 4:3 "A" – 16:9
Set display orientation	0x8e, n "r" "R" "?"	Set display orientation = value/increment/decrement Reset Query	"0" – normal. "1" – vertical inverse. "2" – horizontal inverse. "3" – inverted.
OSD Transparency	0x92, n "+" "-" "r" "R" "?"	Set OSD transparency = value/increment/decrement Reset Query	OSD transparency "0"-"4". 0%, 25%, 50%, 75%, 100%,.
Select menu timeout	0x93, nn "+" "-" "r" "R" "?"	Select menu timeout = value/increment/decrement Reset Query	OSD menu timeout value. "00" – Continuous. value – Round up to nearest available step. if value > max available step, set it to the max available step. "0x30 0x30" -- ON "0x30 0x35" -- 5s "0x30 0x41" – 10s "0x31 0x34" – 20s "0x31 0x45" – 30s "0x33 0x43" – 60s
Select OSD language	0x95, n "r" "R" "?"	Select language = English, French,... Reset Query	"0" – English. "2" – French. "3" – Spanish.
Input source video select	0x98, nn "+" "-" "r" "R" "?"	Select video input = value/next input/previous input Reset Query	"nn" = "0x41,0x31" VGA "0x48,0x31" HDMI1 (Default) "0x48,0x32" HDMI2 "0x48,0x33" HDMI3 "0x46,0x31" DVI "0x59,0x31" Failover (for query only)
Auto source seek	0x99, "0" "1" "r" "R" "?"	Set auto source seek = Disable/Enable Reset Query	Default: "1" (Enable)
Failover on/off	0x99, "0x59,0x31" "0" "1" "?"	Set failover = Disable/Enable Query	"0" - Disable "1" - Enable
GAMMA value select	0x9d, n "r" "R" "?"	Select GAMMA value = Value Reset Query	GAMMA value: "5" – 1.8, "7" – 2.0, "2" – 2.2, "A" – 2.4, "C" – 2.6
Power Down / DPMS Option (Power Saving)	0x9f, "0" "1" "r" "R" "?"	Set power down option = On/Off Reset Query	"0" – Off. "1" – On.
Direct Access (Hotkeys)	0xa0, "1", n "r" "R" "?"	Set Hotkey 1= Value Reset Query	"1" – volume. "2" – backlevel. "3" – contrast. "4" – saturation. "5" – input source. "B" – No function "E" – Aspect "G" – Hue "H" – Brightness "L" – Sharpness
Direct Access	0xa0, "2",	Set Hotkey 2 =	"1" – volume.

(Hotkeys)	n "r" "R" "?"	value Reset Query	"2" – backlevel. "3" – contrast. "4" – saturation. "5" – input source. "B" – No function "E" – Aspect "G" – Hue "H" –Brightness "L" –SharpnessVGA Auto
Set runtime counter	0xa1, nnnnn "r" "R" "?"	Set runtime counter value = nnnnn (* 0.5 hour) Reset Query	Runtime = nnnnn.
Colour temperature select	0xb3, n "r" "R" "?" "i", ss, n "o", ss,	Select colour temperature = value Reset Query	"2" – 6500K. "3" – 5000K. "4" – USER. "5" – 9300K "6" – 7500K. ss - reference by Input Source Select(0x98)
Red level of selected input source user colour temperature	0xb4, nn "+" "-" "r" "R" "?" "m" "n"	Set the level of the red for the selected user colour temp. = value/increment/decrement Reset Query Maximum query Minimum query	nn = "0"0"~ "6"4" (hex of 0~100)
Green level of selected input source user colour temperature	0xb5, nn "+" "-" "r" "R" "?" "m" "n"	Set the level of the green channel for the selected user colour temp. = value/increment/decrement Reset Query Maximum query Minimum query	nn = "0"0"~ "6"4" (hex of 0~100)
Blue level of selected input source user colour temperature	0xb6, nn "+" "-" "r" "R" "?" "m" "n"	Set the level of the blue channel for the selected user colour temp. = value/increment/decrement Reset Query Maximum query Minimum query	nn = "0"0"~ "6"4" (hex of 0~100)
Video horizontal resolution enquiry	0xb7	Horizontal resolution (in pixels) in 3 to 4 digit hex number	
Video vertical resolution enquiry	0xb8	Vertical resolution (in lines) in 3 digit hex number	
Video horizontal sync frequency	0xb9	Horizontal sync frequency (in units of 100Hz) in 3 digit hex number	
Video vertical sync frequency	0xba	Vertical sync frequency (in units of Hz) in 3 digit hex number and 1 char	"nnnc" = vertical frequency nnn = 3 digit hex c= "i" (interlace) or "p" (progressive)
OSD turn off	0xbd	Turn off the OSD.	"0" – fail. "1" – successful.
Backlight control	0xe0, nn "+" "-" "R" "r" "?"	Set Backlight = value/increment/decrement Reset Query	nn = "0"0"~ "6"4" (hex of 0~100) Default: "6"4" (hex of 100)
Backlight On/Off	0xe1, "0" "1" "R" "r" "?"	Backlight Off / Backlight On Reset Query	"0" – Backlight Off "1" – Backlight On. (Default) (non/Off)
Backlight DA/PWM	0xe5 "0" "1" "R" "r" "?"	Set 0:PWM or D/A Reset Query	"0" – PWM "1" – D/A
Backlight PWM Frequency	0xe6, nnn "+" "-" "R" "r" "?"	Set backlight PWM frequency = value/increase 20Hz/decrease 20Hz Reset Query	Value 100Hz : "0", "6", "4" 120Hz : "0", "7", "8" 140Hz : "0", "8", "C" 160Hz : "0", "A", "0" (Default) 180Hz : "0", "B", "4" 200Hz : "0", "C", "8" 220Hz : "0", "D", "C"

			240Hz : "0","F","0" 260Hz : "1","0","4" 280Hz : "1","1","8" 300Hz : "1","2","C" 320Hz : "1","4","0" 340Hz : "1","5","4" 360Hz : "1","6","8" 380Hz : "1","7","C" 400Hz : "1","9","0" 420Hz : "1","A","4" 440Hz : "1","B","8"
Backlight Invert	0xe7 "0" "1" "R" "r" "?"	Set On or Off Reset Query	"0" – Off (Default) "1" – On
Minimum Backlight Value	0xee, "0x5C" nn "+" "-" "R" "r" "?"	Set Minimum Backlight value= value/increment/decrement Reset Query	Minimum Backlight value. nn = "0"~"0"~"3"~"2" (hex of 0~50) Default: "0"~"6"
Default Power	"0xee", "0x6B", "0x50" "0" "1" "?"	Default power state after supplying power to controller Off On Query	"0" - default power off "1" - default power on
User EDID	"0xee", "0x76", "nn" "S" "s" "n,n+1....(256 BYTE) " "E" "e" "n,n+1....(256 BYTE) " "R" "r"	Command Select Port Send 128 BYTE EDID ASCII Code Format (256BYTE) Send 128 BYTE EDID ASCII Code Format (256BYTE) Reset	"nn" = "0x41,0x31"- ARGB "0x46,0x31"- DVI "0x48,0x31" HDMI "0x50,0x31" DisplayPort Return 1 Success Return 0 Fail Return 1 Success Return 0 Fail Return 1 Success Return 0 Fail
EDID Block map for blocks 129 – 254 if more than 128 blocks used Reset			

3. Other control

Function	Command	Description	Acknowledge (if enabled)
Select RS-232 acknowledge	0xc1, "0" "1"	Disable/enable command acknowledge.	"0" – acknowledge disabled. "1" – acknowledge enabled.
Auto-setup (VGA auto adjust)	0xc3	Start auto-setup of current vmode.	"0" – fail. "1" – successful.
Command availability	0xc4, nn / nnnn	Check whether a command is available.	"0" – not available. "1" – available. e.g "0x81" command send "0xc4 0x38 0x31" feedback "0xc4 0x38 0x31 0x31" e.g "0xee 0x41" command send "0xc4 0x45 0x45 0x34 0x31" feedback "0xc4 0x45 0x45 0x34 0x31 0x31"
Auto-calibration (VGA auto color gain)	0xc5	Start auto-calibration of gain of the RGB amplifier.	"0" – fail. "1" – successful.
Power On/Off	0xc8, "0" "1" "?"	Soft power off/on query	"0" – soft power off. "1" – soft power on.

Query video input status	0xc9	Query the status of the primary & pip status	Input status nn nn: "0","0" : no video source "A","1" VGA "F","1" DVI "H","1" HDMI1 "H","2" HDMI2 "H","3" HDMI3
Query BIOS version	0xcb, "0"	Read BIOS version	BIOS version "VV.YY.ZZ" VV = V0 or E0, V0 = Release version E0 = Engineering Sample YY= Version Number ZZ= Customer Number
Query PCBA number	0xcb, "1"	Read PCBA number	"nnnnn" = PCBA number SP-4096= "4" "1" "7" "6" "1"
Query Revision Number	0xcb, "3"	Read Revision Number	"nn" = Revision number AA in firmware version no. "VV.YY.ZZ.AA"
Reset parameter	0xce	Reset all parameters to default value	"1" – successful.
Reset all parameter	0xcf	Reset all parameters, including user color temperature setting, for all video modes to default value	"1" - successful.

Effective on Firmware V1.01.00.00 or up

The RS-232 command strings sent in one time can support up to 380 bytes via CN8 port

n = 1-byte ascii-coded hex number, e.g., parameter value of 0x1 is represented by "1" (0x31).

mn or nn = 2-byte ascii-coded hex number, e.g., parameter value of 0x1e is represented by "1", "e" | "E" (0x31, 0x6e|0x4e).

Please refer to the ASCII to Hex convert table below.

Hex to ASCII conversion table

Hex	ASCII	Hex	ASCII	Hex	ASCII	Hex	ASCII
0x30	0	0x41	A	0x61	a	0x2B	+
0x31	1	0x42	B	0x62	b	0x2D	-
0x32	2	0x43	C	0x63	c	0x3F	?
0x33	3	0x44	D	0x64	d		
0x34	4	0x45	E	0x65	e		
0x35	5	0x46	F	0x66	f		
0x36	6	0x47	G	0x67	g		
0x37	7	0x48	H	0x68	h		
0x38	8	0x49	I	0x69	i		
0x39	9	0x4A	J	0x6A	j		
		0x4B	K	0x6B	k		
		0x4C	L	0x6C	l		
		0x4D	M	0x6D	m		
		0x4E	N	0x6E	n		
		0x4F	O	0x6F	o		
		0x50	P	0x70	p		
		0x51	Q	0x71	q		
		0x52	R	0x72	r		
		0x53	S	0x73	s		
		0x54	T	0x74	t		
		0x55	U	0x75	u		
		0x56	V	0x76	v		
		0x57	W	0x77	w		
		0x58	X	0x78	x		
		0x59	Y	0x79	y		
		0x5A	Z	0x7A	z		

Appendix III – Mapping definition

Definition of division

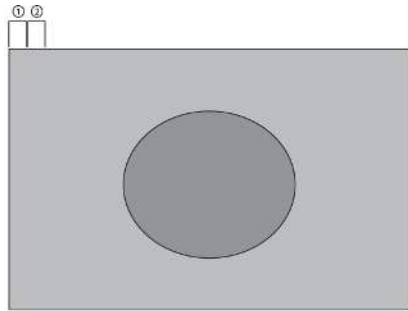

1 Division
(Non-Division)

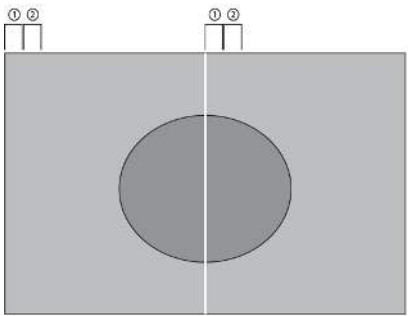

2 Division

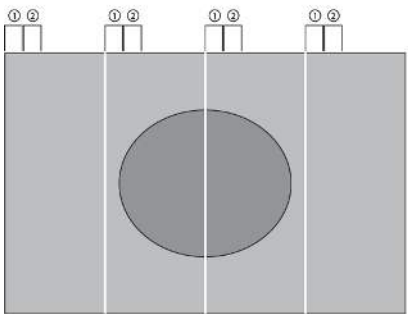

4 Division

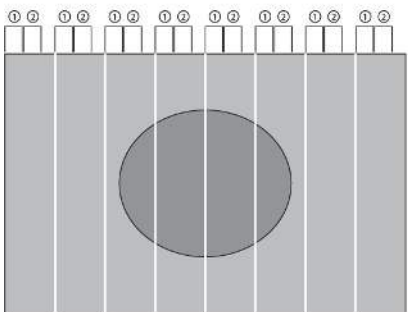

8 Division

Appendix IV – DV remote control unit work for HSP-4096

P/N 559000106-3 :

DigitalView remote control unit
(without DV logo silk screen
printing)

P/N 559000105-3 :

DigitalView remote control unit
(with DigitalView logo silk screen
printing)



BUTTON	FUNCTION
POWER BUTTON	Soft power ON/OFF button.
SEL UP (∧) / SEL DN (∨)	1. In OSD menu, pressing "SEL UP" button to move previous level of selection. 2. In OSD menu, pressing "SEL DN" button to move next level of selection or to CONFIRM the selection.
+ BUTTON	1. When OSD menu displayed, press this button to select functions (forward) or increase the values.
- BUTTON	1. When OSD menu displayed, press this button to select functions (backward) or decrease the values.
AV/TV	1. Show input source selection menu.
OSD NEXT BUTTON	Turn on the OSD menu. Press this button to move to the next menu.
OSD BACK BUTTON	Turn on the OSD menu. Press this button to move to the previous menu.
DISPLAY (i)	1. Turn off the OSD menu. 2. Exit and move to previous level in OSD menu. 3. Press this button to display signal information.
Mute	1. Mute / Un-mute audio (if external audio board is connected)

Appendix V – Media failover function

HSP-4096 has a capability to play media file via USB that this feature called 'Media failover' option. It means when the video input source is no signal / loss of sync on a designated input, the built-in media player displays the video content stored in the USB memory stick on the display automatically.

STEP 1 : To enable the Media Failover function on the OSD menu under 'Setup' page > 'Fail Over' to 'ON' as shown below :

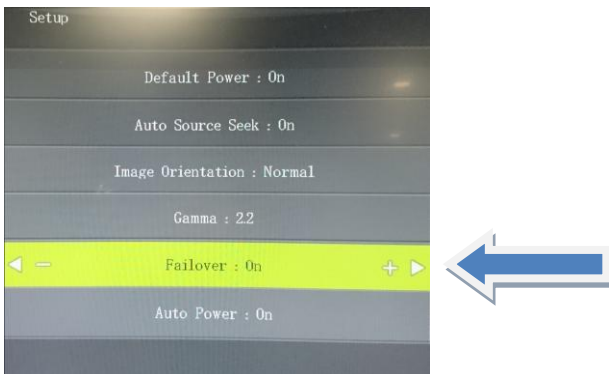

STEP 2 : Stored the media content with .MP4 format in the USB memory stick.

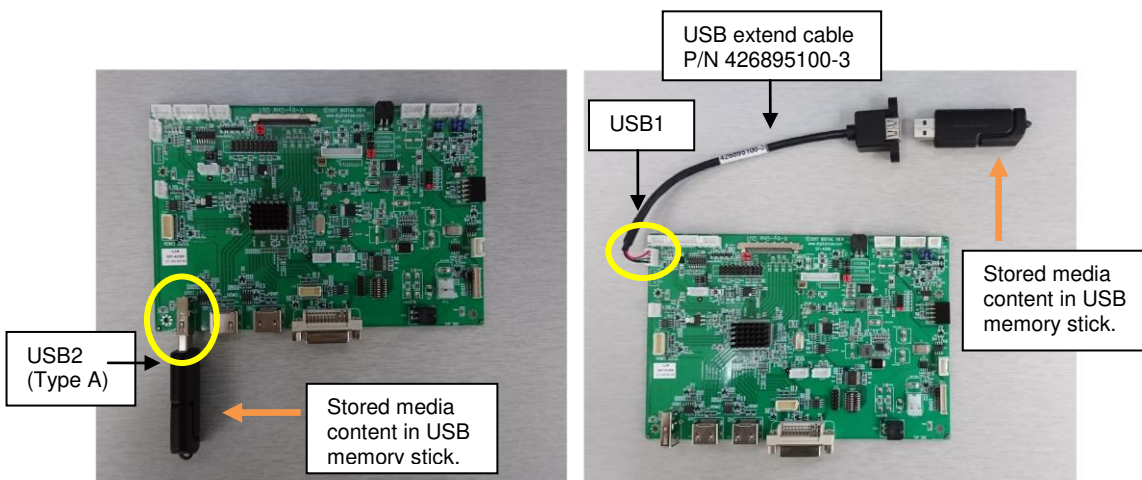

STEP 3 : The built-in media player will run and display the video content stored in the USB memory stick automatically if the video input source is no signal / loss of sync on a designated input.

Note: It will not automatically change to any input that it must be selected via OSD button or serial command or power cycle the controller.

STEP 4 : If you want to go back to display the input signal such as HDMI, press 'MENU' button on the OSD switch mount to trigger the input source selection menu displayed on screen as shown below. Then select the input source you want to jump back. Or just power cycle the controller to switch back.

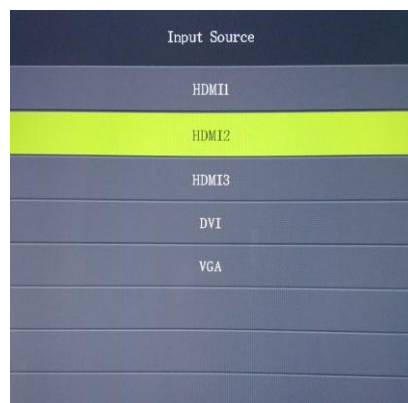

WARRANTY

The products are warranted against defects in workmanship and material for a period of three (3) year from the date of purchase provided no modifications are made to it and it is operated under normal conditions and in compliance with the instruction manual.

The warranty does not apply to:

- Product that has been installed incorrectly, this specifically includes but is not limited to cases where electrical short circuit is caused.
- Product that has been altered or repaired except by the manufacturer (or with the manufacturer's consent).
- Product that has subjected to misuse, accidents, abuse, negligence or unusual stress whether physical or electrical.
- Ordinary wear and tear.

Except for the above express warranties, the manufacturer disclaims all warranties on products furnished hereunder, including all implied warranties of merchantability and fitness for a particular application or purpose. The stated express warranties are in lieu of all obligations or liabilities on the part of the manufacturer for damages, including but not limited to special, indirect consequential damages arising out of or in connection with the use of or performance of the products.

CAUTION

Whilst care has been taken to provide as much detail as possible for use of this product it cannot be relied upon as an exhaustive source of information. This product is for use by suitably qualified persons who understand the nature of the work they are doing and are able to take suitable precautions and design and produce a product that is safe and meets regulatory requirements.

LIMITATION OF LIABILITY

The manufacturer's liability for damages to customer or others resulting from the use of any product supplied hereunder shall in no event exceed the purchase price of said product.

TRADEMARKS

The following are trademarks of Digital View Ltd:

- Digital View
- HSP-4096

CONTACT DETAILS

Digital View has offices in Asia, Europe and USA :

USA

Digital View Inc.
18440 Technology Drive
Building 130
Morgan Hill,
California, 95037
USA

Tel: (1) 408-782 7773 **Fax:** (1) 408-782 7883

Sales: ussales@digitalview.com

EUROPE

Digital View Ltd.
The Lake House
Knebworth Park
Herts, SG3 6PY
UK

Tel: +44-(0)20-7631-2150 **Fax:** +44-(0)20-7631-2156

Sales: uksales@digitalview.com

ASIA

Digital View Ltd
705-708, 7/F Texwood Plaza
6 How Ming St.
Kwun Tong
Hong Kong

Tel: (852) 2861 3615 **Fax:** (852) 2520 2987

Sales: hksales@digitalview.com

WEBSITE

www.digitalview.com

Revision History

Date	Rev No.	Page	Summary
22 August 2017	0.1	All	First issued.
5 February 2018	1.0	8~10 26~29 31~35 39	OSD functions and diagram updated. Added Use of memory and Support modes RS-232 command updated Failover app note.
14 May 2018	1.1	16 26	SW3-5 Operating Temp range
3 July 2019	1.2	27	Removed 2560x1600@60Hz and 3840x2160@30Hz on DVI table.