



DD-40VHz

Dual AC Volt/Frequency

Dual 4 Digit with 0.3" LEDs

in a 1/16 DIN Case

Measuring AC Volts and Frequency, this Dual-Display meter is housed in a low-profile DIN 96 x24 mm short depth case

General Features

The DD-40VHz is a compact, dual 4.0 digit red LED display of AC volts and frequency. The combination of ACV and Hz makes the DD-40VHz ideal for generator set and other stand-by power applications. Both the voltmeter and the frequency meter will display to 0.1 resolution.

Each DD-40VHz has a two-position display intensity selection. With this display dimmer feature, the DD-40VHz can easily be seen in direct sunlight. Then the low intensity setting can be selected for night operation.

The DD-40VHz is housed in a short-depth 2.2" (111 mm) deep, 96X48 mm 1/16 DIN horizontal case. This compact case style allows for maximum visibility while demanding a very small panel space. The DD-40VHz uses a high-efficiency AC/DC switching power supply that allows operation from any AC voltage (85 to 265 VAC) or DC voltage (90 to 380 VDC).

Typical Application Connections

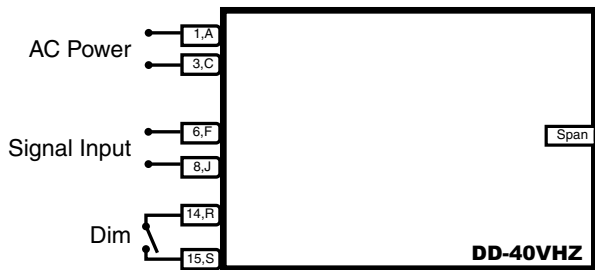

Compatibility

The DD-Series have a matching DIN case style that is complementary to the Lynx, Leopard and Tiger family of meters. DD-Meters are the OEM's choice for economical switchboard and process indication. For economy, each model is dedicated to a specific application and designed for quick and easy installation.



Specifications

- Input Configuration:**Single-ended input
- A/D Converter:**..... 14 Bit Single Slope
- Accuracy:**± (0.2% of reading + 1 digit)
- Temperature Coefficient:** ..5 ppm/°C in ratiometric mode
- Warm up time:** 1 Minute
- Conversion Rate:**.....3 conversions per second
- Display:**.....0.3" (7 mm) high red LEDs.
Dual 4.0 digit displays
- Decimal Selection:**Preselected to XXX.X for volts and frequency
- Over-range Indication:** "----"
- Power Supply:**85 to 265 VAC / 90 to 380 VDC
switching power supply. 2 watts.
- Operating Temperature:**..0 °C to 60 °C
- Storage Temperature:**-20°C to +70°C
- Relative Humidity:**95% (non-condensing)
- Case Dimensions:**Bezel: 96X24 mm (3.62" X 0.95")
Depth behind bezel: 56.5 mm (2.23")
Plus 27 mm (1.06") for Push-On connector
or plus 17.5 mm (0.68") for Edge connector
- Weight:**85 gms (3 oz)
170 gms (6 oz) when packed

DD-Series, the OEMs choice for switchboard and process indication

DD-40VHz.....Dual Display of AC Volts (30.0 to 350.0V AC) and frequency (20.0 to 450.0 Hz)

Functional Diagram

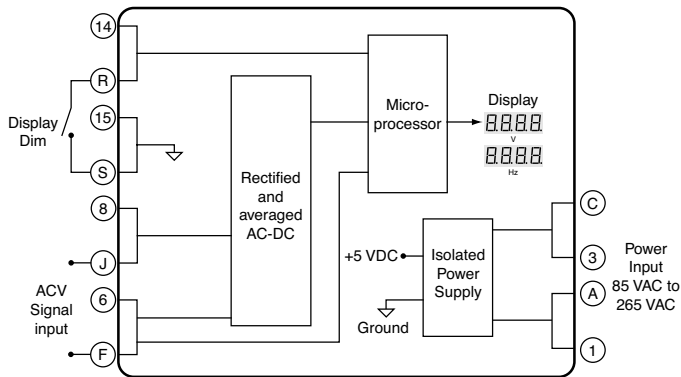

Connector Pinouts

The Texmate DD-40VHz uses a standard PC board edge connector with two rows of 15 pins, spaced on 0.156" centers, for signal and power connection. The DD-40VHz is designed for simple connection to the signal source. There is only one signal input for the AC voltage being monitored. The frequency is automatically sensed and displayed on the right-hand side of the DD-40VHz.

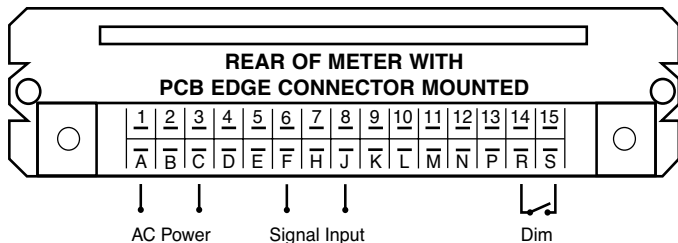

METER REAR WITH PCB EDGE CONNECTOR MOUNTED

(For mounting of screw terminal blocks see rear page)

COMPONENT SIDE PINS

SOLDER SIDE PINS

AC/DC Power Input - 1 AC AC **A - AC/DC Power Input**

AC/DC Power Input - 3 AC AC **C - AC/DC Power Input**

Signal High Input - 6 SIG SIG **F - Signal High Input**

Signal Low Input - 8 SIG SIG **J - Signal Low Input**

Not Used - 10 **L - Not Used**

Not Used - 11 **M - Not Used**

Not Used - 12 **N - Not Used**

Not Used - 13 **P - Not Used**

Display Dim - 14 SW SW **R - Display Dim**

Display Dim Common - 15 **S - Display Dim Common**

Pins 1 and A – Power Input: AC voltage from 85 to 265V AC or 90 to 380V DC power may be applied. These pins are internally connected.

Pins 2 and B – Not used: There is no internal connection.

Pins 3 and C – Power Input: AC voltage from 85 to 265V AC or 90 to 380 VDC power may be applied. These pins are internally connected.

Pins 4 and D – Not used: There is no internal connection.

Pins 5 and E – Not used: There is no internal connection.

Pins 6 and F – Input Signal: These pins are internally connected. Input voltage levels applied are from 30 VAC to 350 VAC. Maximum overload is 600 VAC / VDC.

Pins 7 and H – Not used: There is no internal connection.

Pins 8 and J – Input Signal: These pins are internally connected. Input voltage levels applied are from 30 VAC to 350 VAC. Maximum overload is 600 VAC / VDC.

Pins 9 and K – Not used: There is no internal connection.

Pins 10 and L – Not used: There is no internal connection.

Pins 11 and M – Not used: There is no internal connection.

Pins 12 and N – Not used: There is no internal connection.

Pins 13 and P – Not used: There is no internal connection.

Pins 14 and R – Display Dim Connection: Short to Pin 14 or R to decrease the display intensity by 50%.

Pins 15 and S – Display Dim Connection: Short to Pin 12 or N to decrease the display intensity by 50%.

Component Layout

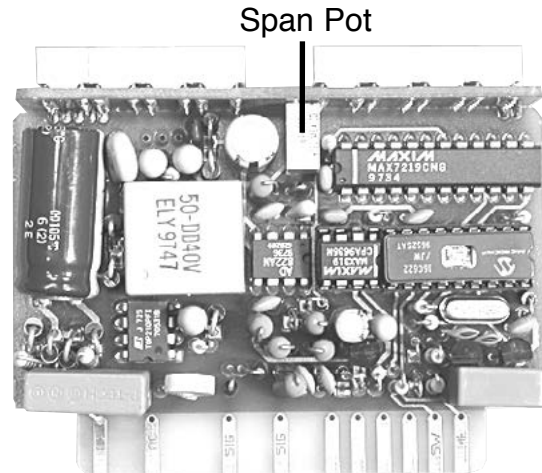

Signal Conditioning Component

SPAN **SPAN Potentiometer (Pot)**

To the Right Front
Turn Clockwise to Increase Reading

The 15 turn SPAN pot is always on the right side (as viewed from the front of the meter). Typical adjustment is 20% of the input signal range.

Circuit Description

The DD-40VHz is supplied from the factory with an internally isolated auto-sensing AC/DC switching power supply. The power supply will operate from an AC voltage within a range of 85 to 265 VAC and 90 to 380 VDC. If the power source to the DD-40VHz changes from AC to DC, the DD-40VHz will continue to operate. Although specified to operate from 85 to 265 VAC, the DD-40VHz can still function with an AC supply as low as 40 VAC. Texmate recommends that the AC power source be within the specified range of 85 to 265 VAC.

The AC input signal is rectified and averaged before being sampled by a single-slope A/D converter. From the A/D converter, the AC input signal and the digital representation of the input voltage are fed into a microprocessor to calculate the frequency. Both the AC input voltage and the frequency are displayed on two separate four-digit, seven-segment LED displays.

With an external switch, the meter display can be set to two levels of brightness. The microprocessor detects the display selection setting of the switch and, in turn, applies this setting to the display.

Calibration Procedure

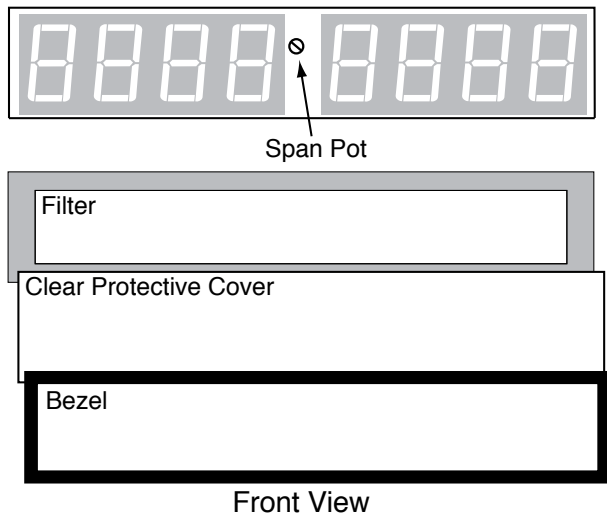

The DD-40VHz is calibrated at the factory with a precision AC voltage source. A calibrator of 0.05% accuracy is required to completely check the operation of the DD-40VHz meter.

1. Carefully snap off and remove the front bezel, clear protective cover, and filter. The span adjust pot will now be visible.
2. Make sure there is a proper AC or DC power source available that is within the specified parameters.
3. Connect the power source to Pins 1 and 3 (Pins A and C).
4. Connect the calibrator to the input signal pins 6 and 8 (Pins F and J) and apply an AC voltage between 90 and 350 VAC.
5. Adjust the span potentiometer at the front of the meter until the displayed AC voltage reading agrees with the calibrator input signal. Frequency calibration is not required.
6. The DD-40VHz is now calibrated and ready for use.

Power Supply

The DD-40VHz is supplied from the factory with an internally isolated auto-sensing AC/DC switching power supply. This power supply will operate from an AC voltage anywhere within a range of 85 to 265 VAC or 90 to 370 VDC.

If the meter's power source changes from AC to DC, the DD-40VHz will continue to operate. The DD-40VHz, although specified to operate from 85 to 265 VAC, can still function with an AC supply as low as 40 VAC. It is recommended that the AC power source be within the specified range of 85 to 265 VAC.

Push-On Screw Terminals

They provide the greatest convenience and ease of use

Texmate's exclusive optional Push-On Connectors combine an edge card connector and a 10 position screw terminal block. Push-On Connectors are ordered preconfigured for each specific power supply voltage and each optional power supply available for the DD-Series.

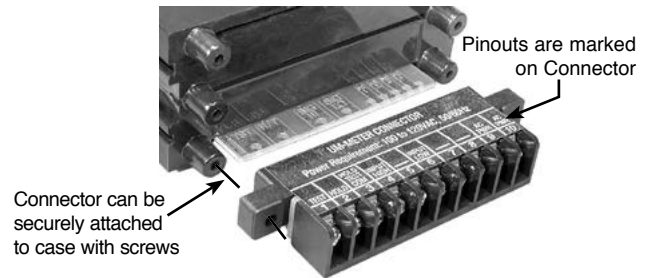

A standard 30-pin edge card connector can be used to connect the DD-40VHz. As an alternative, however Texmate has designed an extremely easy-to-use connector called the Push-On™ connector. This exclusive connector design combines an edge card connector and screw terminal blocks into one piece. To order, use part number DD-PUSH/DD.

Optional PCB Edge Card Connector

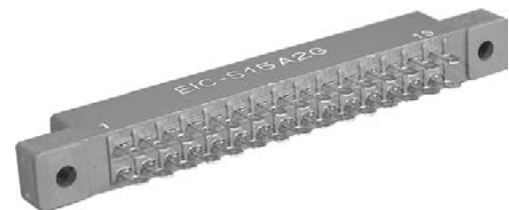

A standard 30 pin edge connector (two rows of 15 pins on 0.156" centers) may also be used to connect the DD-40VHz. Order part no. CN-L15.

Custom Face Plates



Texmate Produces Thousands of Custom OEM Face Plates

Have Texmate Design and produce a Custom Face Plate for your next project!

- Custom face plates have a non-recurring artwork charge. A serial number is then assigned to each artwork to facilitate reordering.
- Small Run or One-Off custom face plates incur an installation charge, and are generally printed on a special plastic film, which is then laminated to custom faceplate blanks as required.
- Large Run (300 pieces min): custom face plates are production silk screened, issued a part number, and held in stock for free installation as required by customer orders.
- OEMs may also order Custom Meter Labels, Box Labels, Custom Data Sheets and Instruction Manuals.

Case Dimensions and Panel Cutouts

PANEL CUTOUT

Case will mount in standard 1/16 DIN cutouts

Panel adaptor plates are available to retrofit most existing panel cutouts.

For additional strength, extra Mounting Slide Clips can be ordered and doubled up one behind the other.
P/N: (75-DMT96X24)

When extra panel mounting tightness is required, optional Screw Mounting Clips are included which fit on the Mounting Slide Clips.

Various bezel colors are available. Black is standard.

FRONT VIEW

1/16 DIN (96x24mm)

SIDE VIEW

5.4mm (0.21")
21.85mm (0.86")
56.5mm (2.23")
27mm (1.06")
5mm (0.20")
Push-On Connector P/N: (CN/PUSH/BN)

TO REMOVE REAR COVER

Top Catches
Bottom Catch
Release Bottom Catch with a small flat blade, and lever outwards.

17.5mm (0.69")
Edge Connector P/N: (CN-L15)

The 96x24mm case is particularly suitable for mounting in mosaic panels or insulative panels. They can also stack mount, 2 up in existing cut-outs for 1/8 DIN (96x48mm) or 4 up in 1/4 DIN (96x96mm).

TOP VIEW

25.4mm (3.78") Max. panel thickness
96mm (3.78")
92.8mm (3.6") Widest mountable panel cutout without using adaptors.
97.8mm (3.86")
91mm (3.59")

Ordering Information

Standard Options for this Model Number

Part Number	Description	List
-------------	-------------	------

► **BASIC MODEL NUMBER** Includes plug in type screw terminals, standard display and standard power supply unless optional versions are ordered.

DD-40VHZ 4.0 digit, dual V/Hz display, 30-350 VAC/20-450 Hz input

Special Options and Accessories

Part Number	Description	List
-------------	-------------	------

► ACCESSORIES

- DN.CAS96X24 . 96x24mm Complete Short Depth Case w/Bezel .
- 75-DBBZ96X24. Black Bezel for 96x24mm Case
- 75-DMTC96X24 Mounting Slide Clips, extra set (96x24mm case size)
- CN-L15 Dual Row 15 Pin Edge Connector
- CN-PUSH/DD . . . Push-on Screw Terminal Block Connector.
- OP-MTLCLIP Screw Mounting Clips (2pc) to screw tighten slide brackets
- 75-DTP96X24 . . . Black Metal Trim Plate (96x24mm Case) 1 Meter . .
- 75-DTP2X9624 . . Black Metal Trim Plate (96x24mm Case) 2 Meters
- 75-DTP3X9624 . . Black Metal Trim Plate (96x24mm Case) 3 Meters

Prices subject to change without notice.

WARRANTY

Texmate warrants that its proDXcts are free from defects in material and workmanship under normal use and service for a period of one year from date of shipment. Texmate's obligations under this warranty are limited to replacement or repair, at its option, at its factory, of any of the proDXcts which shall, within the applicable period after shipment, be returned to Texmate's facility, transportation charges pre-paid, and which are, after examination, disclosed to the satisfaction of Texmate to be thus defective. The warranty shall not apply to any equipment which shall have been repaired or altered, except by Texmate, or which shall have been subjected to misuse, negligence, or accident. In no case shall Texmate's liability exceed the original purchase price. The aforementioned provisions do not extend the original warranty period of any proDXct which has been either repaired or replaced by Texmate.

USER'S RESPONSIBILITY

We are pleased to offer suggestions on the use of our various proDXcts either by way of printed matter or through direct contact with our sales/application engineering staff. However, since we have no control over the use of our proDXcts once they are shipped, NO WARRANTY WHETHER OF MERCHANTABILITY, FITNESS FOR PURPOSE, OR OTHERWISE is made beyond the repair, replacement, or refund of purchase price at the sole discretion of Texmate. Users shall determine the suitability of the proDXct for the intended application before using, and the users assume all risk and liability whatsoever in connection therewith, regardless of any of our suggestions or statements as to application or construction. In no event shall Texmate's liability, in law or otherwise, be in excess of the purchase price of the proDXct.

Texmate cannot assume responsibility for any circuitry described. No circuit patent or software licenses are implied. Texmate reserves the right to change circuitry, operating software, specifications, and prices without notice at any time.



450 State Place • Escondido, CA 92029

Tel: 1-760-598-9899 • USA 1-800-839-6283 • That's 1-800-TEXMATE

Fax: 1-760-598-9828 • Email: orders@texmate.com • Web: www.texmate.com

For product details visit www.texmate.com

Local Distributor Address