

WR-430 Waveguide Antenna, 1.7 GHz to 2.6 GHz Frequency Range, 15 dBi Gain,

Waveguide Antennas Technical Data Sheet

PEWAN430-15

Features

- WR-430 Rectangular Waveguide Interface
- 1.7 GHz to 2.6 GHz
- 15 dBi Nominal Gain
- CPR-430F Cover Flange
- L Band

Applications

- Antenna Measurements
- Wireless Communication
- Laboratory Use
- Microwave Radio Systems

Description

The PEWAN430-15 L Band standard gain horn antenna (also known as waveguide horn) from Pasternack has a nominal gain of 15 dBi. This WR-430 standard gain horn has a CPR-430F type flange. The Pasternack 15 dBi WR-430 horn antenna operates from 1.7 GHz to 2.6 GHz. The WR-430 PEWAN430-15 waveguide horn is Powder coated Aluminum for added protection and corrosion resistance. It is part of over 40,000 RF, microwave and millimeter wave components available from Pasternack. Waveguide standard gain horn antennas are used in a wide variety of applications due to their high power handling capability, low loss, high directivity, and near constant electrical performance. Pasternack's WR-430 standard gain horns are available in 10, 15 and 20 dBi models with pyramidal shape and rectangular input. Our WR-430 standard gain horn antennas can ship worldwide the same day as it is purchased as with our other available RF parts.

Configuration

Design	WR-430
Polarization	Linear

Electrical Specifications

Description	Minimum	Typical	Maximum	Units
Frequency Range	1.7		2.6	GHz
Nominal Gain		15		dB
Horizontal Half Power Beam Width		31		Degrees
Vertical Half Power Beam Width		32		Degrees
VSWR		1.3:1		

Mechanical Specifications

Size	
Length	14.646 in [372.01 mm]
Width	11.653 in [295.99 mm]
Height	8.385 in [212.98 mm]
Weight	3.75 lbs [1.7 kg]

Waveguide Interface

Waveguide Size	WR-430
----------------	--------

Click the following link (or enter part number in "SEARCH" on website) to obtain additional part information including price, inventory and certifications: [WR-430 Waveguide Antenna, 1.7 GHz to 2.6 GHz Frequency Range, 15 dBi Gain, PEWAN430-15](#)



WR-430 Waveguide Antenna, 1.7 GHz to 2.6 GHz Frequency Range, 15 dBi Gain,

Waveguide Antennas Technical Data Sheet

PEWAN430-15

Flange Type
Body Material and Plating

CPR-430F
Aluminum, Gray

Compliance Certifications (see [product page](#) for current document)

Plotted and Other Data

Typical Performance Data

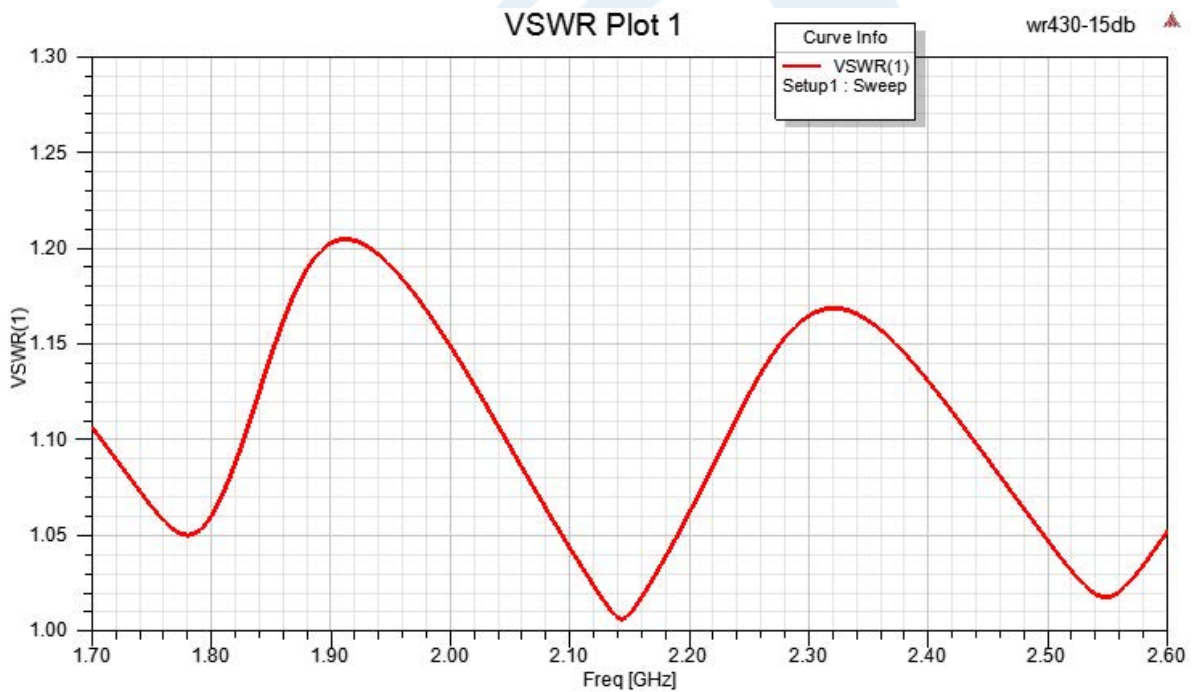

Click the following link (or enter part number in “SEARCH” on website) to obtain additional part information including price, inventory and certifications: [WR-430 Waveguide Antenna, 1.7 GHz to 2.6 GHz Frequency Range, 15 dBi Gain, PEWAN430-15](#)



WR-430 Waveguide Antenna, 1.7 GHz to 2.6 GHz Frequency Range, 15 dBi Gain,

Waveguide Antennas Technical Data Sheet

PEWAN430-15

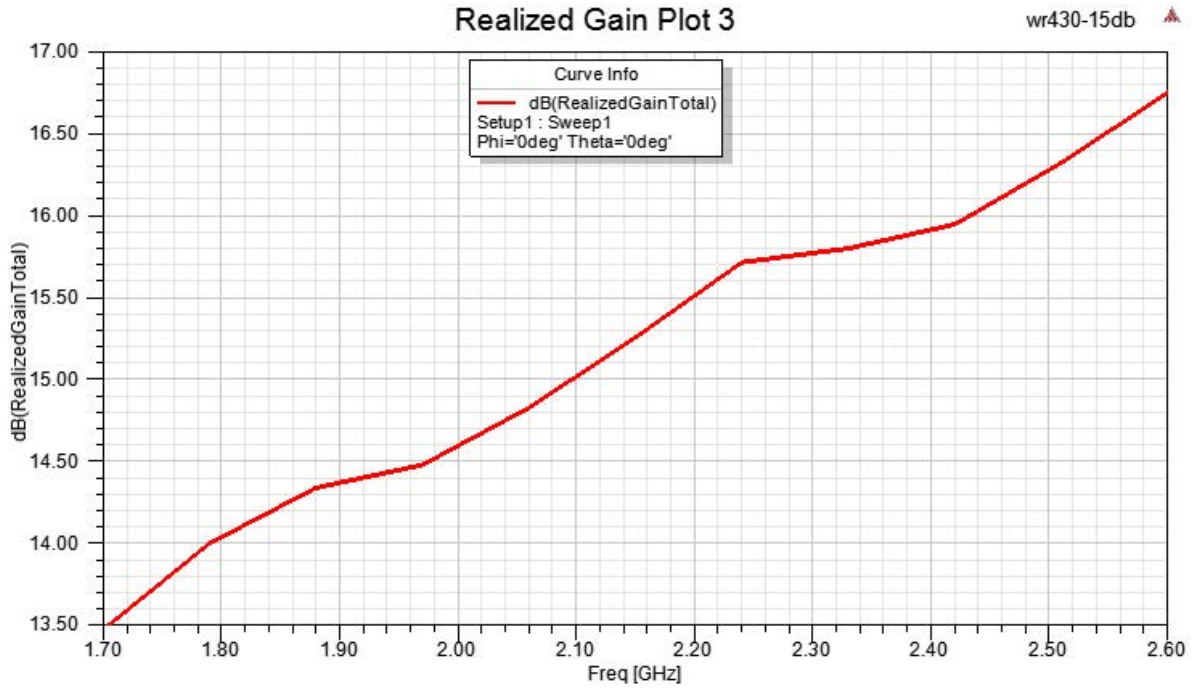

Click the following link (or enter part number in "SEARCH" on website) to obtain additional part information including price, inventory and certifications: [WR-430 Waveguide Antenna, 1.7 GHz to 2.6 GHz Frequency Range, 15 dBi Gain, PEWAN430-15](#)



WR-430 Waveguide Antenna, 1.7 GHz to 2.6 GHz Frequency Range, 15 dBi Gain,

Waveguide Antennas Technical Data Sheet

PEWAN430-15

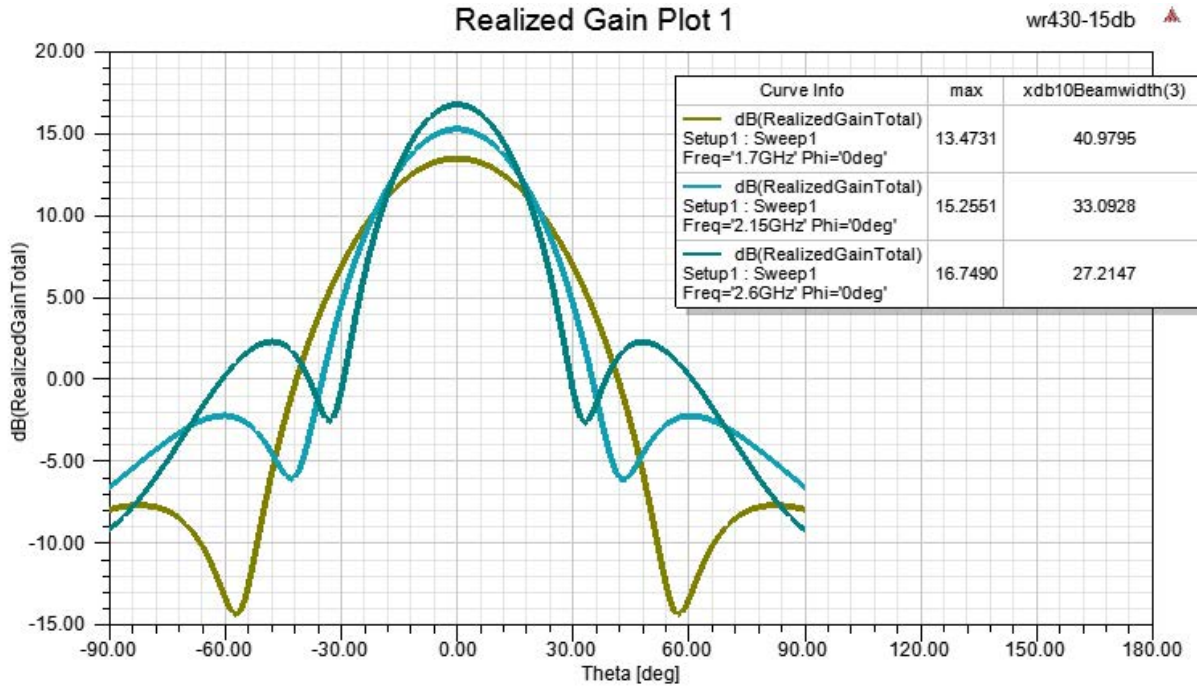

Click the following link (or enter part number in "SEARCH" on website) to obtain additional part information including price, inventory and certifications: [WR-430 Waveguide Antenna, 1.7 GHz to 2.6 GHz Frequency Range, 15 dBi Gain, PEWAN430-15](#)

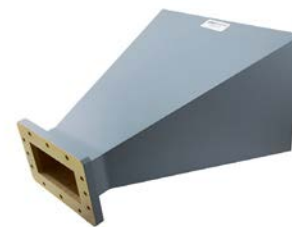

WR-430 Waveguide Antenna, 1.7 GHz to 2.6 GHz Frequency Range, 15 dBi Gain,

Waveguide Antennas Technical Data Sheet

PEWAN430-15

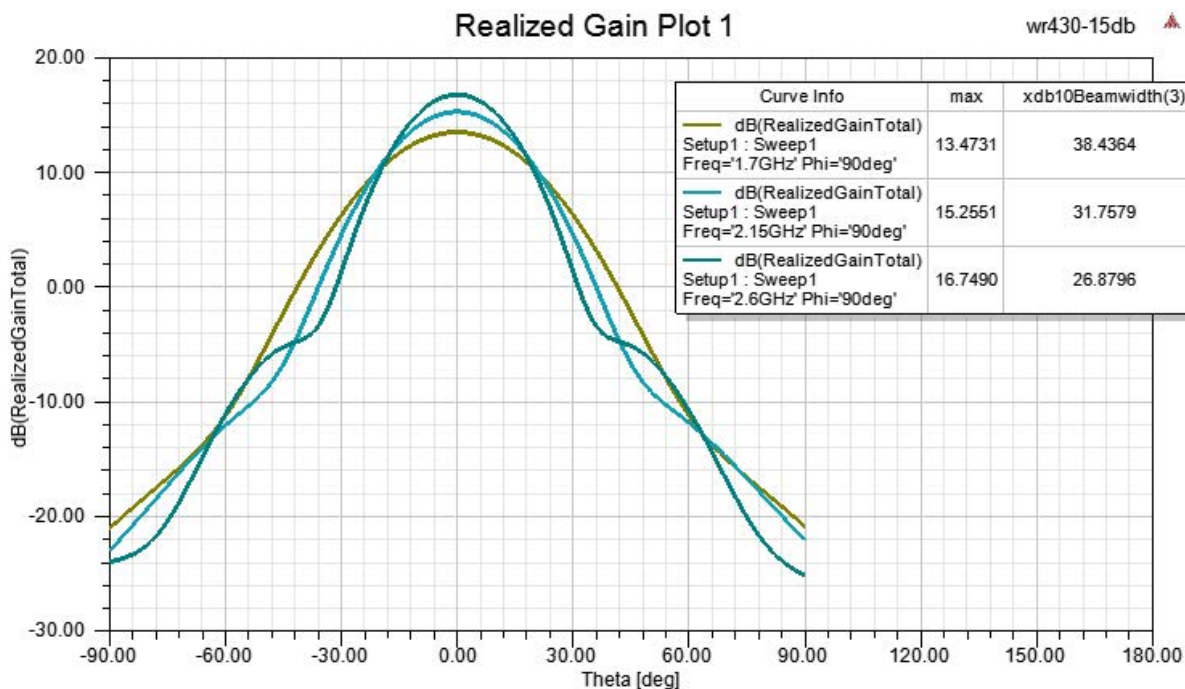

WR-430 Waveguide Antenna, 1.7 GHz to 2.6 GHz Frequency Range, 15 dBi Gain, from Pasternack Enterprises has same day shipment for domestic and International orders. Our RF, microwave and millimeter wave products maintain a 99.4% availability and are part of the broadest selection in the industry.

Click the following link (or enter part number in "SEARCH" on website) to obtain additional part information including price, inventory and certifications: [WR-430 Waveguide Antenna, 1.7 GHz to 2.6 GHz Frequency Range, 15 dBi Gain, PEWAN430-15](https://www.pasternack.com/wr-430-waveguide-gain-horn-antenna-15db-cpr-430f-flange-pewan430-15-p.aspx)

URL: <https://www.pasternack.com/wr-430-waveguide-gain-horn-antenna-15db-cpr-430f-flange-pewan430-15-p.aspx>

The information contained in this document is accurate to the best of our knowledge and representative of the part described herein. It may be necessary to make modifications to the part and/or the documentation of the part, in order to implement improvements. Pasternack reserves the right to make such changes as required. Unless otherwise stated, all specifications are nominal. Pasternack does not make any representation or warranty regarding the suitability of the part described herein for any particular purpose, and Pasternack does not assume any liability arising out of the use of any part or documentation.

PEWAN430-15 CAD Drawing

WR-430 Waveguide Antenna, 1.7 GHz to 2.6 GHz Frequency Range, 15 dBi Gain,

REVISIONS			
REV.	DESCRIPTION	DATE	APPROVED
A	INITIAL RELEASE	06/01/2021	KHIETPAS

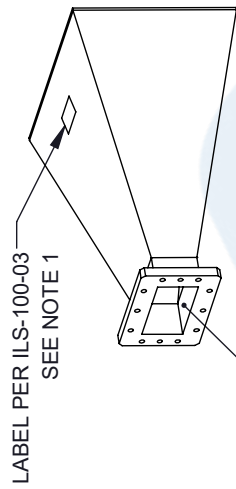

WR-430
CPR-430F FLANGE

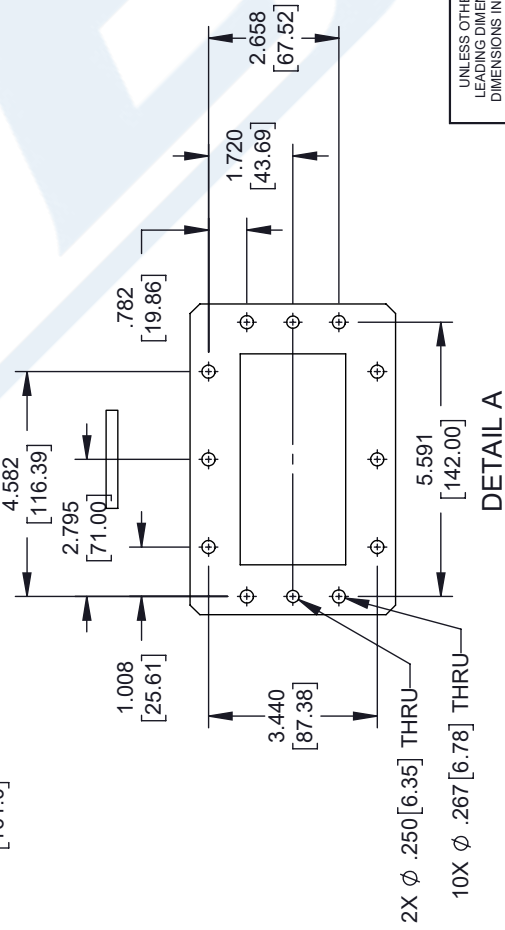
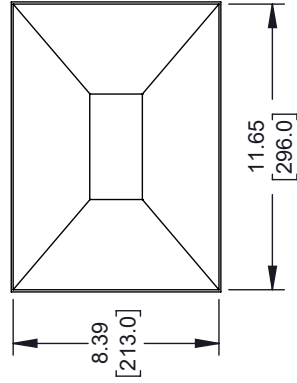
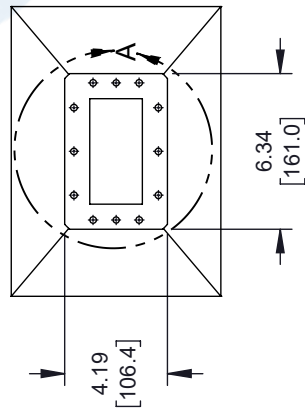
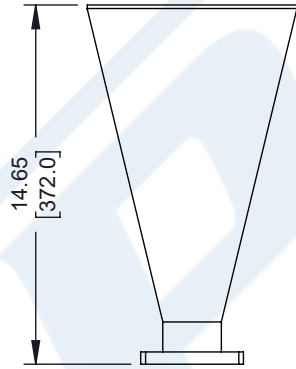

DETAIL A

NOTES:

1. LABEL PER ILS-100-03 (FOR INTERNAL REFERENCE ONLY)
LABEL LOCATION FOR REFERENCE ONLY

THESE COMMODITIES, TECHNOLOGY OR SOFTWARE WERE EXPORTED FROM THE UNITED STATES IN ACCORDANCE WITH THE EXPORT ADMINISTRATION REGULATIONS. DIVERSION CONTRARY TO U.S. LAW PROHIBITED.

UNLESS OTHERWISE SPECIFIED
LEADING DIMENSIONS ARE INCHES
DIMENSIONS IN [] ARE MILLIMETERS

TOLERANCES:
.X = ±.2 [5.08] FRACTIONS ±.1032
.XX = ±.02 [.51] ANGLES ± 1°
.XXX = ±.005 [.13] CABLE LENGTH (L) TOLERANCES:
L ≤ 12 [305] = +1 [25] / -0
12 [305] < L ≤ 60 [1524] = +2 [51] / -0
60 [1524] < L ≤ 120 [3048] = +4 [102] / -0
120 [3048] < L ≤ 300 [7620] = +6 [152] / -0
300 [7620] < L = +5% / -0

ALL DIMENSIONS SHOWN
ARE FOR REFERENCE ONLY.

PEJ PASTERNAK
an INFINITI brand

Pasternack Enterprises, Inc.
P. O. Box 16759, Irvine, CA 92623.
Phone: 1.949.261.1920 | 1.866.727.8376
Fax: 1.949.261.7451
Website: www.pasternack.com
E-mail: sales@pasternack.com

SCALE: N/A

SHEET 1 OF 1

THIRD-ANGLE PROJECTION

THE INFORMATION AND DESIGN IN THIS DOCUMENT IS THE PROPERTY OF PASTERNAK CORPORATION. ALL RIGHTS RESERVED.

ITEM NO. PEWAN430-15

DRAWN BY: DZINN

CAGE CODE: 53919

REV: A