

50V, 500mA, Low-I_Q 30μA Low-Dropout Linear Regulator with Enable

DESCRIPTION

The TQL851CSV50 is a high-performance low dropout linear regulator for 5V with input range of 3V to 50V and low quiescent 30μA. TQL851CSV50 provides 2% output voltage accuracy and 500mA maximum driving current and is suitable for automotive or other supply systems. TQL851CSV50 just requires one small ceramic capacitor of 1μF to exhibit fast regulation and good stability. And it shows very low dropout voltage with typical 60mV in 100mA-load and 150mV in 250mA-load. The start operating voltage is 3V which is suitable to cranking condition of automotive system.

The device has an enable function to switch ON and OFF for power dissipation. And other protection functions such as thermal-shutdown and current-limit are against immediate damage.

APPLICATION

- Automotive Power Supply Systems
- General Power Supply applications

FEATURES

- AEC-Q100 qualified with the following results:
 - Device temperature grade 1: -40°C to 125°C
 - Device HBM ESD classification level H2
 - Device CDM ESD classification level C3
- 3V to 50V Input Voltage Range
- 5V Fixed Output Voltage
- Typical 60mV @100mA Low Dropout Voltage
- 500mA Output Current
- Typical 30μA Low Quiescent Current
- Typical ±2% Output Voltage Accuracy
- 1μF Ceramic Output Stable Capacitor
- Output Current Limit
- Over Temperature Protection
- RoHS Compliant
- Halogen-Free according to IEC 61249-2-21

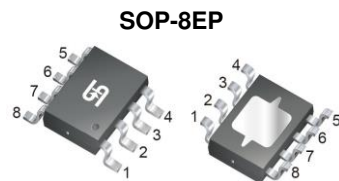

Pin Definition:

- | | |
|-------|--------|
| 1.IN | 5. NC |
| 2.EN | 6. NC |
| 3.NC | 7. NC |
| 4.GND | 8. OUT |

Notes: Moisture sensitivity level: level 3. Per J-STD-020

TYPICAL APPLICATION CIRCUIT

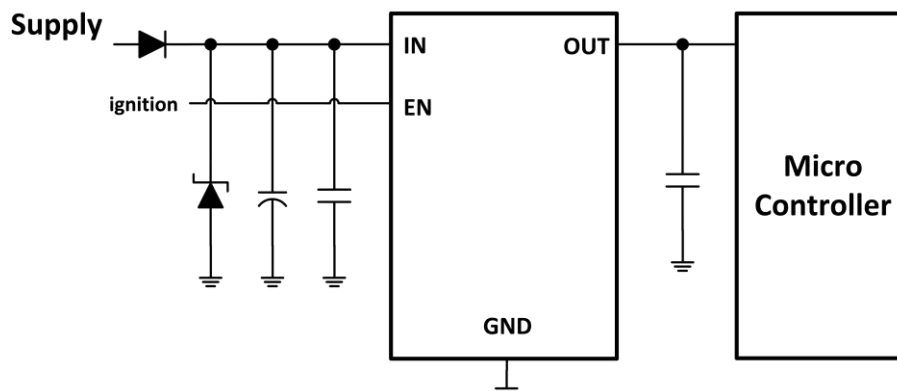

ABSOLUTE MAXIMUM RATINGS ($T_A = 25^\circ\text{C}$ unless otherwise specified) (Note 1)			
PARAMETER	SYMBOL	LIMIT	UNIT
Power Supply Pin	V_{IN}	55	V
EN Voltage to GND	V_{EN}	-0.3 to 55	V
OUT/RO/WDO Voltage to GND	$V_{OUT}/V_{RO}/V_{WDO}$	-0.3 to 7	V
WDI/RTH Voltage to GND	V_{WDI}/V_{RTH}	-0.3 to 7	V
Junction Temperature Range	T_J	-40 to +150	$^\circ\text{C}$
Storage Temperature Range	T_{STG}	-55 to +150	$^\circ\text{C}$
ESD Rating (Human Body Model) (Note 2)	HBM	± 2	kV
ESD Rating (Charged Device Model)	CDM	± 1	kV

THERMAL PERFORMANCE			
PARAMETER	SYMBOL	TYP	UNIT
Junction to Case Thermal Resistance	$R_{\theta JC}$	15	$^\circ\text{C}/\text{W}$
Junction to Ambient Thermal Resistance	$R_{\theta JA}$	50	$^\circ\text{C}/\text{W}$

Notes: The thermal data is based on the PCB JESD 51-3 at natural convection on 1s0p board with 1 copper layer (1 x 70 μm Cu) and with 300mm² heatsink area on PCB

RECOMMENDED OPERATING CONDITIONS (Note 3)			
PARAMETER	SYMBOL	CONDITIONS	UNIT
Power Supply Pin	V_{IN}	$V_{OUT} + V_{dr}$ to 50	V
Extended Power Supply Pin	$V_{IN,ext}$	3 to 50	V
EN Voltage to GND	V_{EN}	0 to 50	V
Output Stable Capacitor	C_{OUT}	≥ 1	μF
ESR of Output Capacitor	ESR	≤ 100	Ω
Operating Junction Temperature Range	T_J	-40 to +150	$^\circ\text{C}$
Operating Ambient Temperature Range	T_{OPA}	-40 to +125	$^\circ\text{C}$

ELECTRICAL SPECIFICATIONS ($V_{IN} = 13.5\text{V}$, $T_J = -40$ to 150°C unless otherwise noted)						
PARAMETER	CONDITIONS	SYMBOL	MIN	TYP	MAX	UNIT
Supply Voltage						
Output Voltage	$0.05\text{mA} < I_{OUT} < 500\text{mA}$ $5.95\text{V} < V_{IN} < 28\text{V}$	V_{OUT}	4.9	5	5.1	V
Output Voltage	$0.05\text{mA} < I_{OUT} < 200\text{mA}$ $5.44\text{V} < V_{IN} < 40\text{V}$	V_{OUT}	4.9	5	5.1	V
Start-up Slew-rate	$V_{IN} > 18\text{V}/\text{ms}$ $C_{OUT} = 1\mu\text{F}$ $0.5\text{V} < V_{OUT} < 4.5\text{V}$	dV_{OUT}/dt	--	35	--	V/ms
Current Limit	$0\text{V} < V_{OUT} < 4.8\text{V}$	I_{lim}	--	600	--	mA
Load Regulation	$I_{OUT} = 0.05$ to 500mA $V_{IN} = 6\text{V}$	$\Delta V_{OUT,lo}$	-20	-1.5	+15	mV

ELECTRICAL SPECIFICATIONS ($V_{IN} = 13.5V$, $T_J = -40$ to $150^{\circ}C$ unless otherwise noted)						
PARAMETER	CONDITIONS	SYMBOL	MIN	TYP	MAX	UNIT
Supply Voltage						
Line Regulation	$V_{IN} = 8$ to $32V$ $I_{OUT} = 5mA$	$\Delta V_{OUT,li}$	-20	0	20	mV
Dropout Voltage ($V_{dr}=V_{IN}-V_{OUT}$)	$I_{OUT} = 250mA$	V_{dr}	--	150	425	mV
Dropout Voltage ($V_{dr}=V_{IN}-V_{OUT}$)	$I_{OUT} = 100mA$	V_{dr}	--	60	170	mV
Power Supply Ripple Rejection	$f = 100Hz$, $V = 0.5V_{pp}$	PSRR	--	59	--	dB
Thermal Shutdown Threshold (Note 4)		T_{th}	151	--	200	$^{\circ}C$
Thermal Shutdown Hysteresis (Note 4)		T_{hy}	--	30	--	$^{\circ}C$
Current Consumption						
Standby Current ($I_O=I_{IN}$)	$V_{EN} = 0V$, $T_J < 105^{\circ}C$	$I_{O,st}$	--	1.3	5	μA
Standby Current ($I_O=I_{IN}$)	$V_{EN} = 0.4V$, $T_J < 125^{\circ}C$	$I_{O,st}$	--	--	8	μA
Quiescent Current ($I_O=I_{IN}-I_{OUT}$)	$I_{OUT} = 0.05mA$, $T_J = 25^{\circ}C$	I_O	--	30	40	μA
Quiescent Current ($I_O=I_{IN}-I_{OUT}$)	$I_{OUT} = 0.05mA$, $T_J < 125^{\circ}C$	I_O	--	45	60	μA
Enable						
High Level Input Voltage		V_{ENH}	2	--	--	V
Low Level Input Voltage	$V_{OUT} \leq 0.1V$	V_{ENL}	--	--	0.8	V
Threshold Hysteresis		V_{ENHy}	100	--	--	mV
EN Input Current	$V_{EN} = 3.3V$	I_{EN}	--	--	3.5	μA
EN Input Current	$V_{EN} \leq 18V$	I_{EN}	--	--	22	μA
EN Pull-down Resistor		R_{EN}	0.95	1.5	2.6	$M\Omega$

Note:

1. Stresses listed as the above "Absolute Maximum Ratings" may cause permanent damage to the device. These are for stress ratings. Functional operation of the device at these or any other conditions beyond those indicated in the operational sections of the specifications is not implied. Exposure to absolute maximum rating conditions for extended periods may remain possibility to affect device reliability.
2. Devices are ESD sensitive. Handling precaution recommended.
3. The device is not guaranteed to function outside its operating conditions.
4. Guaranteed by design.

ORDERING INFORMATION

ORDERING CODE	PACKAGE	PACKING
TQL851CSV50 RLG	SOP-8EP	2,500pcs / 13" Reel

BLOCK DIAGRAM

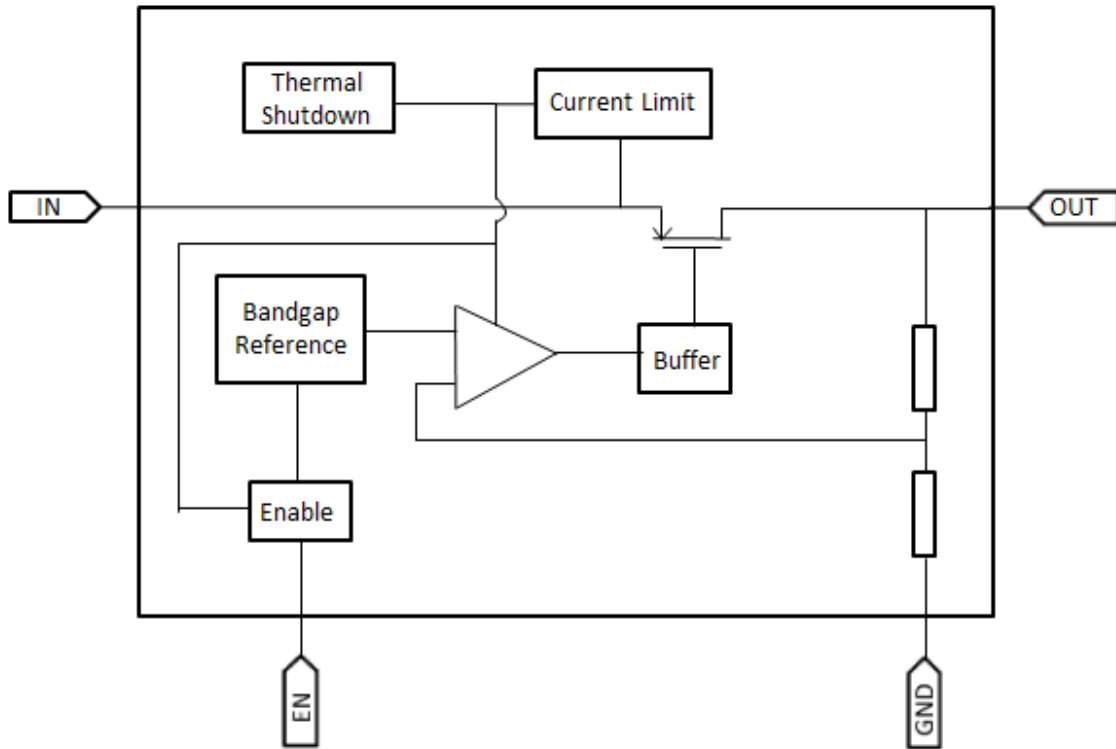

PIN DESCRIPTION

PIN NO.	NAME	FUNCTION
1	IN	Power supply pin for system
2	EN	Enable system function
3	NC	No connect
4	GND	Ground
5	NC	No connect
6	NC	No connect
7	NC	No connect
8	OUT	Output supply voltage
Pad	--	Connect to GND

APPLICATION INFORMATION

TQL851CSV50 is a high-performance low dropout voltage regulator. The device operates with a wide input voltage from 3V to 50V and up to 500mA of output current. It also provides a high accuracy output voltage for $\pm 2\%$ in all the load and line regulation.

Enable

The EN pin is high voltage tolerant pin. High input enables the device ON and low is disable which can be connected to microcontroller or digital control system. It can be connected to input power pin directly.

Thermal Shutdown (TSD)

Internal 160°C comparator will trigger temperature protection (TSD). TSD will shut down system, until internal temperature back to 130°C.

Current Limit

The TQL851CSV50 features Current Limit function to protect device from damage by excessive power dissipation such as OUT shorted to GND. It limits output current to maintain power dissipation in the safe region.

TYPICAL OPERATING CHARACTERISTICS

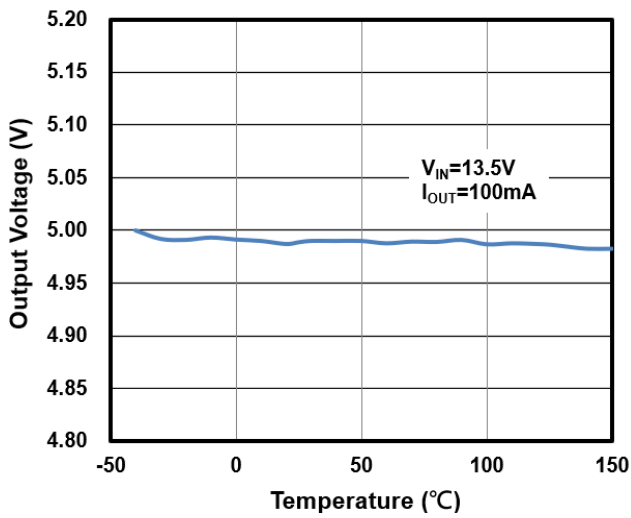

Figure 1. Output Voltage vs. Junction Temperature

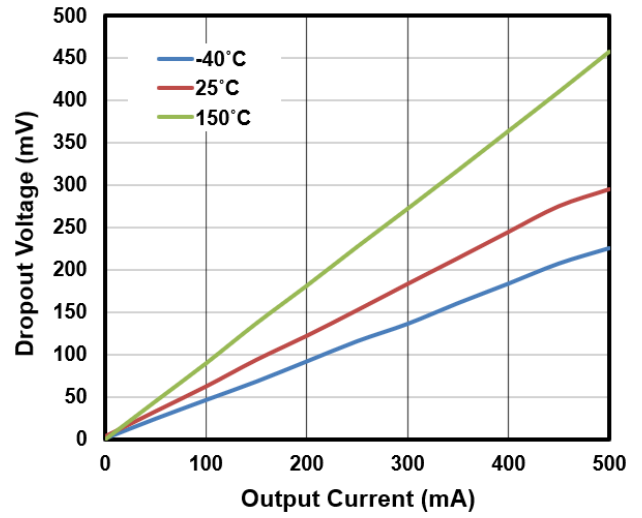

Figure 2. Dropout Voltage vs. Output Current

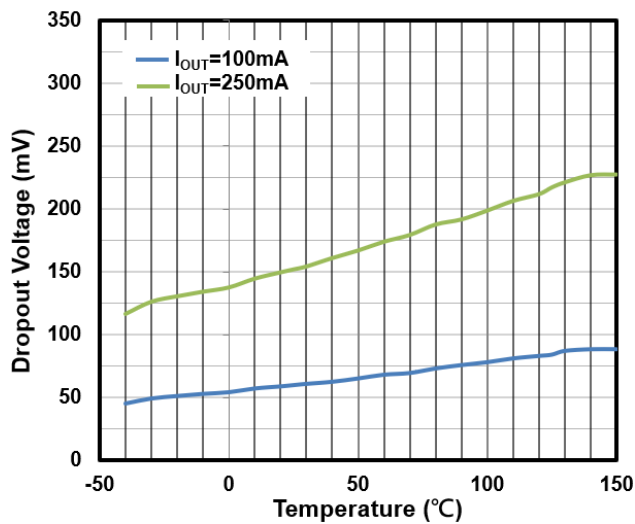

Figure 3. Dropout Voltage vs. Junction Temperature

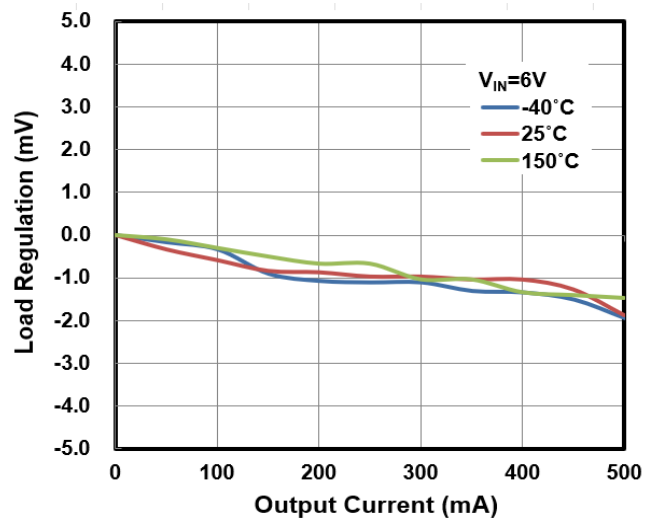

Figure 4. Load Regulation vs. Output Current

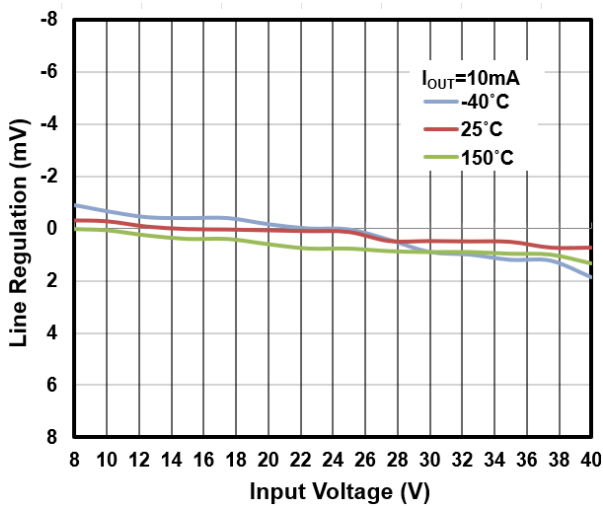

Figure 5. Line Regulation vs. Input Voltage

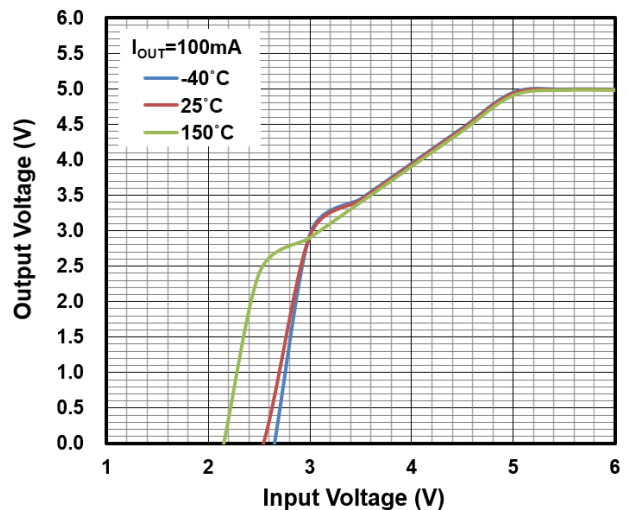

Figure 6. Output Voltage vs. Input Voltage

TYPICAL OPERATING CHARACTERISTICS (CONTINUE)

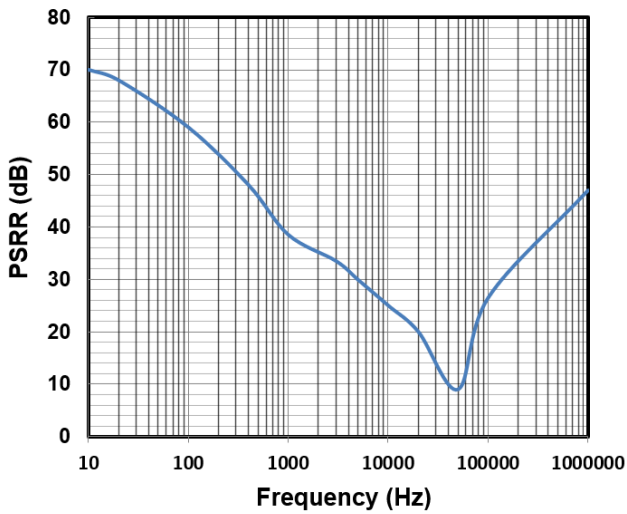

Figure 7. Ripple Rejection vs. Frequency

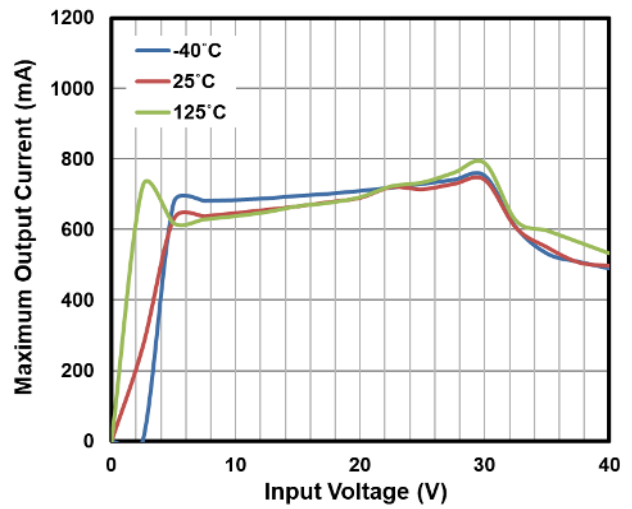

Figure 8. Output Current vs. Input Voltage

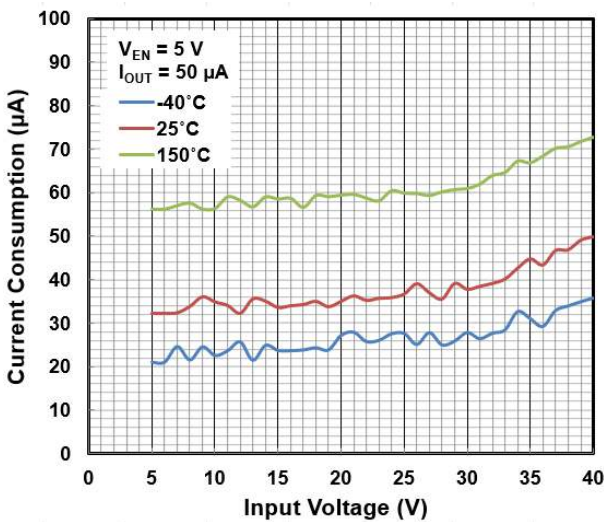

Figure 9. Current Consumption vs. Input Voltage

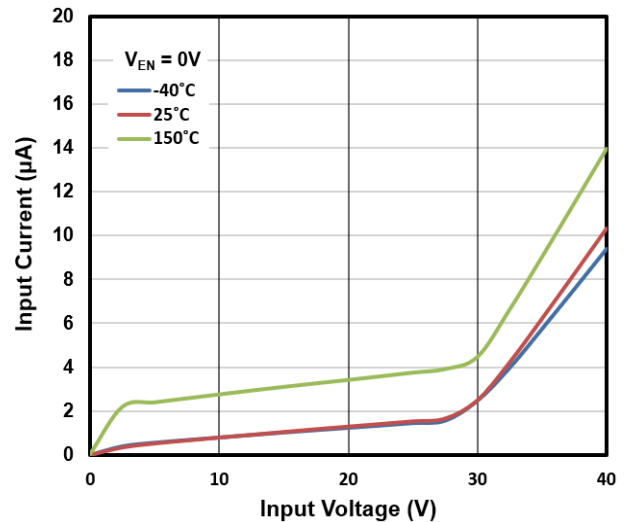

Figure 10. Input Current vs. Input Voltage

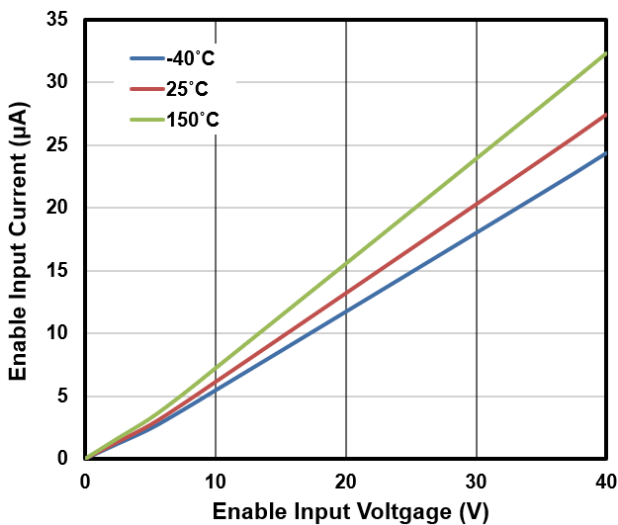

Figure 11. Enabled Input Current vs. Enabled Input Voltage

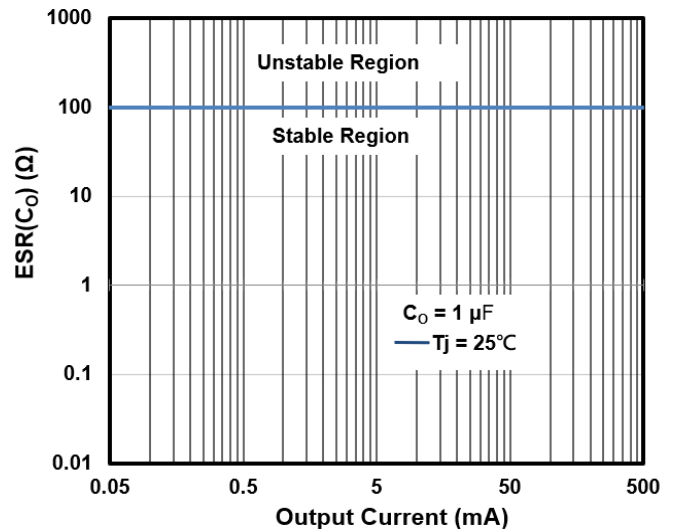

Figure 12. Output Capacitor Series Resistor ESR(C_O) vs. Output Current

TYPICAL OPERATING CHARACTERISTICS (CONTINUE)

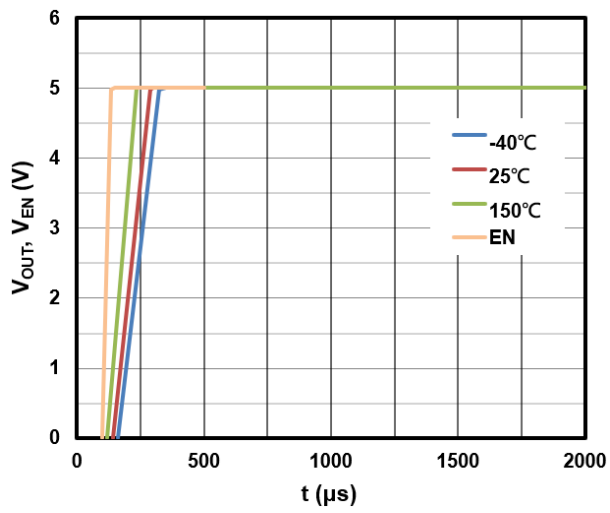
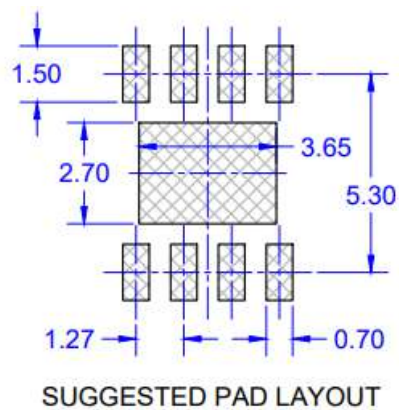
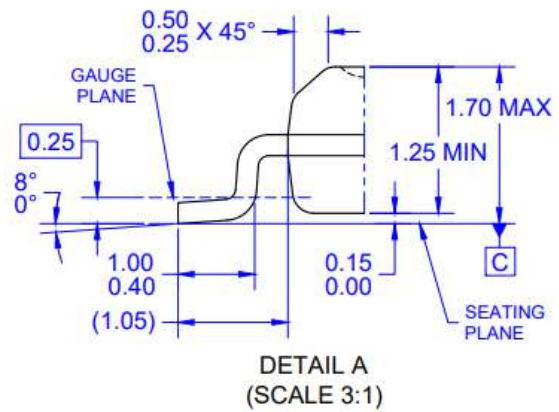
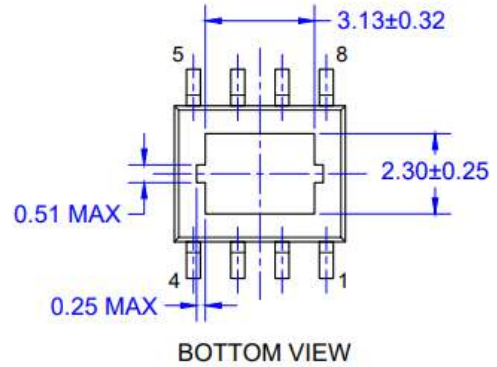
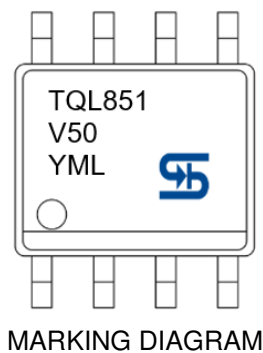
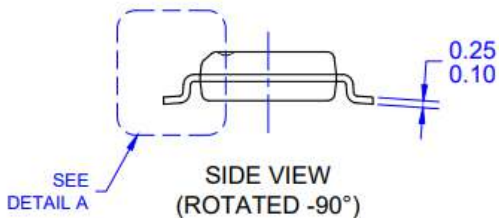
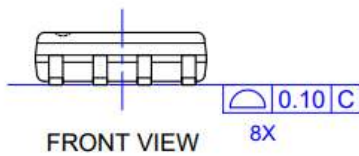
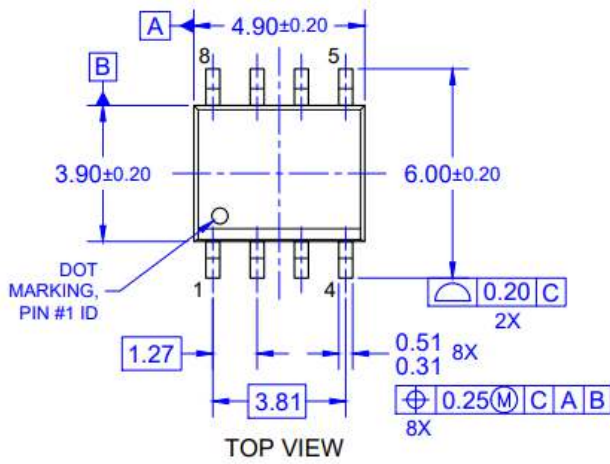

Figure 13. Output Voltage vs. time (EN switched ON)

PACKAGE OUTLINE DIMENSIONS

SOP-8EP



- Y** = Year Code
- M** = Month Code for Halogen Free Product
 - O** =Jan **P** =Feb **Q** =Mar **R** =Apr
 - S** =May **T** =Jun **U** =Jul **V** =Aug
 - W** =Sep **X** =Oct **Y** =Nov **Z** =Dec
- L** = Lot Code (1~9, A~Z)

NOTES: UNLESS OTHERWISE SPECIFIED

1. ALL DIMENSIONS ARE IN MILLIMETERS.
2. DIMENSIONING AND TOLERANCING PER ASME Y14.5M-1994.
3. PACKAGE OUTLINE REFERENCE: JEDEC MS-012, ISSUE G, VARIATION BA.
4. MOLDED PLASTIC BODY DIMENSIONS DO NOT INCLUDE MOLD FLASH, PROTRUSIONS OR GATE BURRS.
5. DWG NO REF: HQ2SD07-030 REV A.

Notice

Specifications of the products displayed herein are subject to change without notice. TSC or anyone on its behalf, assumes no responsibility or liability for any errors or inaccuracies.

Purchasers are solely responsible for the choice, selection, and use of TSC products and TSC assumes no liability for application assistance or the design of Purchasers' products.

Information contained herein is intended to provide a product description only. No license, express or implied, to any intellectual property rights is granted by this document. Except as provided in TSC's terms and conditions of sale for such products, TSC assumes no liability whatsoever, and disclaims any express or implied warranty, relating to sale and/or use of TSC products including liability or warranties relating to fitness for a particular purpose, merchantability, or infringement of any patent, copyright, or other intellectual property right.

The products shown herein are not designed for use in medical, life-saving, or life-sustaining applications. Customers using or selling these products for use in such applications do so at their own risk and agree to fully indemnify TSC for any damages resulting from such improper use or sale.