

XS630B5PBL2

Inductive proximity sensors XS, inductive sensor XS6 M30, L64mm, brass, Sn30mm, 12...48 VDC, cable 2 m



Main

Range of Product	Telemecanique Inductive proximity sensors XS
Series name	General purpose
Sensor Type	Inductive proximity sensor
Device Application	Mobile equipment
Sensor name	XS6
Sensor design	Cylindrical M30
Size	64 mm
Body type	Fixed
Detector flush mounting acceptance	Non flush mountable
Material	Metal
Type of output signal	Discrete
Wiring Technique	3-wire
[Sn] nominal sensing distance	1.18 in (30 mm)
Discrete output function	1 NC
Output circuit type	DC
Discrete output type	PNP
Electrical connection	Cable
Cable length	6.56 ft (2 m)
[Us] rated supply voltage	12...48 V DC reverse polarity protection
Switching capacity in mA	<= 200 mA DC overload and short-circuit protection
IP degree of protection	IP65 conforming to IEC 60529 IP67 conforming to DIN 40050 IP69K

Complementary

Thread type	M30 x 1.5
Detection face	Frontal
Front material	PPS
Enclosure Material	Nickel Plated Brass
Sensing range	> 0.59...1.57 in (> 15...40 mm)
Operating zone	0.00...0.94 in (0...24 mm)
Differential travel	1...15% of Sr
Cable composition	3 x 0.34 mm ²
Wire insulation material	PvR
Status LED	Output state 1 LED yellow)
Supply voltage limits	10...58 V DC
Switching frequency	<= 500 Hz DC
Maximum voltage drop	<2 V closed)
Current consumption	<= 10 mA no-load
Maximum delay first up	15 ms
Maximum delay response	0.6 ms
Maximum delay recovery	1.4 ms
Marking	CE

Threaded length	1.54 in (39 mm)
Length	2.52 in (64 mm)
Net Weight	0.45 lb(US) (0.205 kg)

Environment

Product Certifications	CSA E2 UL
Ambient Air Temperature for Operation	-13...158 °F (-25...70 °C)
Ambient Air Temperature for Storage	-40...185 °F (-40...85 °C)
Vibration resistance	25 gn +/- 2 mm 10...55 Hz)IEC 60068-2-6
Shock resistance	50 gn 11 ms IEC 60068-2-27

Ordering and shipping details

Category	22486-SENSORS, PROXIMITY
Discount Schedule	DS2
GTIN	3389119630672
Nbr. of units in pkg.	1
Package weight(Lbs)	7.20 oz (204.0 g)
Returnability	No
Country of origin	FR

Packing Units

Unit Type of Package 1	PCE
Package 1 Height	1.57 in (4 cm)
Package 1 width	3.74 in (9.5 cm)
Package 1 Length	5.31 in (13.5 cm)

Offer Sustainability

Sustainable offer status	Green Premium product
California proposition 65	WARNING: This product can expose you to chemicals including: Diisononyl phthalate (DINP), which is known to the State of California to cause cancer, and Di-isodecyl phthalate (DIDP), which is known to the State of California to cause birth defects or other reproductive harm. For more information go to www.P65Warnings.ca.gov
REACH Regulation	REACH Declaration
EU RoHS Directive	Pro-active compliance (Product out of EU RoHS legal scope) EU RoHS Declaration
Mercury free	Yes
RoHS exemption information	Yes
Environmental Disclosure	Product Environmental Profile
Circularity Profile	End Of Life Information

Dimensions

Pre-cabled

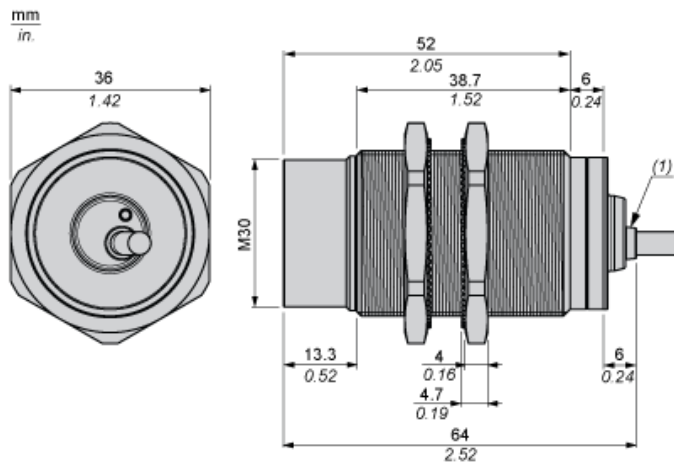

(1) Yellow LED (Output state indication)

Mounting and Clearance

Minimum Mounting Distances

Side by Side

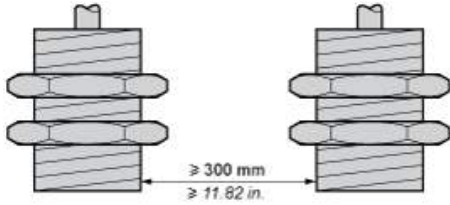

Face to Face

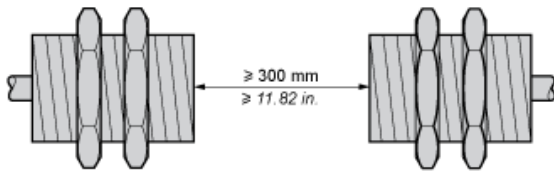

Facing a Metal Object

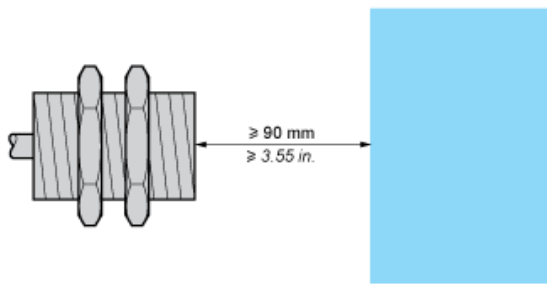

Mounted in a Metal Support

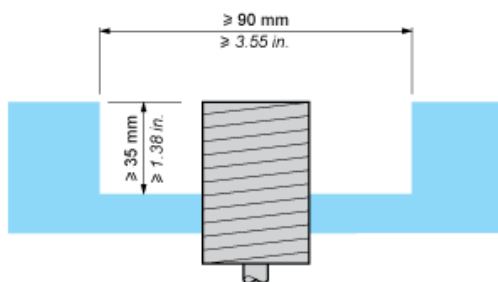

Connection and Schema

Wiring Schemes

PNP 3-wire

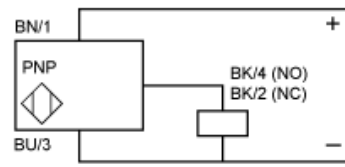

BN : Brown
BK : Black
BU : Blue

Performance Curves

Standard Steel Target: 45 x 45 x 1 mm

Operating zone: 0...24 mm

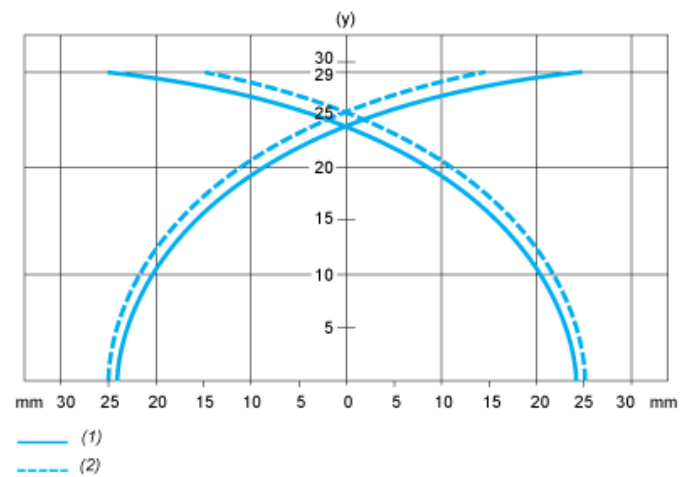

- (y) Sensing distance in mm
- (1) Pick-up points
- (2) Drop-out points (object approaching from the side)