

172164-1 ✓ ACTIVE

MATE-N-LOK | Mini-Universal MATE-N-LOK

TE Internal #: 172164-1

Rectangular Power Connectors, Housing, Plug, Wire-to-Wire, 1 Position, Wire & Cable, UL 94V-0, Mini-Universal MATE-N-LOK

[View on TE.com >](#)



Connectors > Power Connectors > Rectangular Power > Rectangular Power Connectors



Rectangular Power Connector Type: **Housing**

Connector & Housing Type: **Plug**

Connector System: **Wire-to-Wire**

Number of Positions: **1**

Sealable: **No**

Features

Product Type Features

Rectangular Power Connector Type	Housing
Connector & Housing Type	Plug
Connector System	Wire-to-Wire
Sealable	No
Connector & Contact Terminates To	Wire & Cable

Configuration Features

Number of Positions	1
Number of Rows	1

Electrical Characteristics

Operating Voltage	600 VDC
-------------------	---------

Contact Features

Multiple Contact Types	Without
Contact Layout	Inline
Contact Retention Within Housing	Without



Contact Type	Socket
--------------	--------

Termination Features

Termination Method to Wire & Cable	Crimp
------------------------------------	-------

Mechanical Attachment

Panel Mount Feature	Without
---------------------	---------

Connector Mounting Type	Panel Mount
-------------------------	-------------

Housing Features

Housing Color	Natural
---------------	---------

Housing Material	Nylon 66
------------------	----------

Dimensions

Product Width	6.9 mm
---------------	--------

Product Length	23.7 mm
----------------	---------

Usage Conditions

Operating Temperature Range	-20 – 105 °C[-4 – 221 °F]
-----------------------------	---------------------------

Operation/Application

Circuit Application	Power & Signal
---------------------	----------------

Industry Standards

CSA Rating	Certified, LR 7189
------------	--------------------

UL Rating	Recognized
-----------	------------

Agency/Standard	CSA, UL
-----------------	---------

Approved Standards	UL E28476
--------------------	-----------

UL Flammability Rating	UL 94V-0
------------------------	----------

Glow Wire Rating	Standard Part - Not Glow Wire
------------------	-------------------------------

Packaging Features

Packaging Quantity	500
--------------------	-----

Packaging Method	Bag
------------------	-----

Product Compliance

[For compliance documentation, visit the product page on TE.com>](#)

EU RoHS Directive 2011/65/EU	Compliant
------------------------------	-----------

EU ELV Directive 2000/53/EC	Compliant
-----------------------------	-----------

China RoHS 2 Directive MIIT Order No 32, 2016	No Restricted Materials Above Threshold
---	---



EU REACH Regulation (EC) No. 1907/2006

Current ECHA Candidate List: JUNE 2023 (235)

Candidate List Declared Against: JAN 2023 (233)

SVHC > Threshold:

Melamine (3% in Component Part)

Article Safe Usage Statements:

Wash thoroughly after handling. Do not handle until all safety precautions have been read and understood. Recycle if possible and dispose of the article by following all applicable governmental regulations relevant to your geographic location.

Halogen Content

Low Halogen - Br, Cl, F, I < 900 ppm per homogenous material. Also BFR/CFR/PVC Free

Solder Process Capability

Not applicable for solder process capability

Product Compliance Disclaimer

This information is provided based on reasonable inquiry of our suppliers and represents our current actual knowledge based on the information they provided. This information is subject to change. The part numbers that TE has identified as EU RoHS compliant have a maximum concentration of 0.1% by weight in homogenous materials for lead, hexavalent chromium, mercury, PBB, PBDE, DBP, BBP, DEHP, DIBP, and 0.01% for cadmium, or qualify for an exemption to these limits as defined in the Annexes of Directive 2011/65/EU (RoHS2). Finished electrical and electronic equipment products will be CE marked as required by Directive 2011/65/EU. Components may not be CE marked. Additionally, the part numbers that TE has identified as EU ELV compliant have a maximum concentration of 0.1% by weight in homogenous materials for lead, hexavalent chromium, and mercury, and 0.01% for cadmium, or qualify for an exemption to these limits as defined in the Annexes of Directive 2000/53/EC (ELV). Regarding the REACH Regulation, the information TE provides on SVHC in articles for this part number is based on the latest European Chemicals Agency (ECHA) 'Guidance on requirements for substances in articles' posted at this URL: <https://echa.europa.eu/guidance-documents/guidance-on-reach>

Compatible Parts



TE Part # 1-770988-1
MINI UMNL SOK 22-18AWG LP LF



TE Part # 1-770985-0
MINI UMNL PIN 26-22AWG AU LP



TE Part # 1-770987-0
MINI UMNL PIN 22-18 AWG AU LP



TE Part # 770988-3
MINI UMNL SOK 22-18AWG AU LP



TE Part # 1-770988-0
MINI UMNL SOK 22-18AWG AU



TE Part # 1-794059-0
MINI UMNL PIN L/P LF



TE Part # 770988-1
MINI UMNL SOK 22-18AWG SN LP



TE Part # 770986-1
MINI UMNL SOK 26-22AWG SN LP



Also in the Series | Mini-Universal MATE-N-LOK

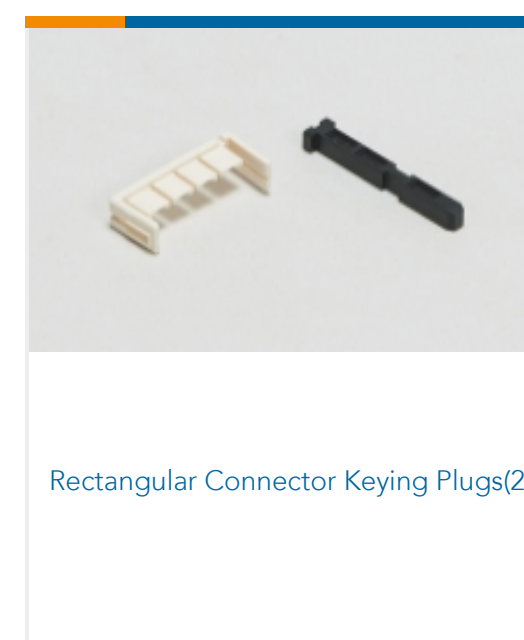
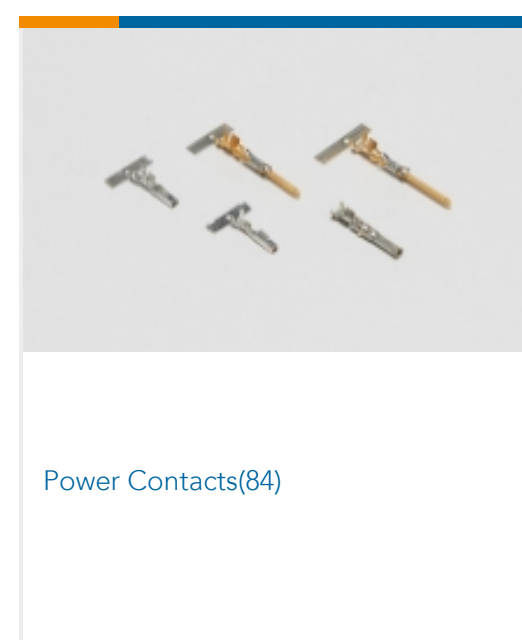
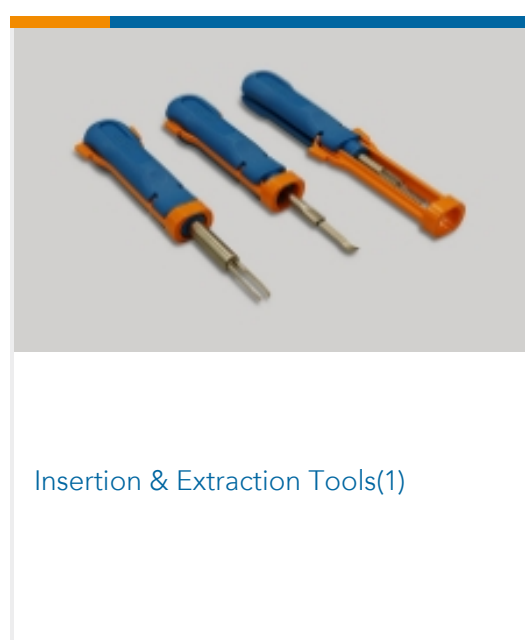
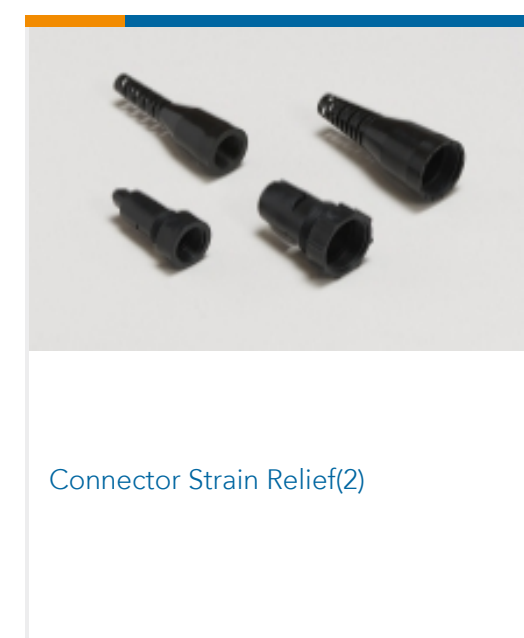
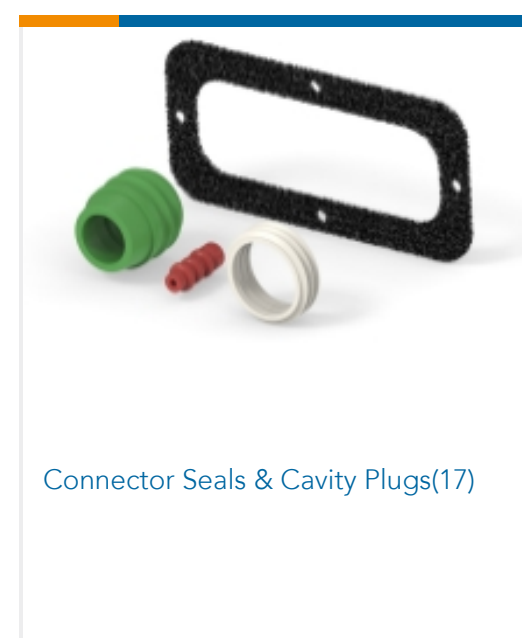
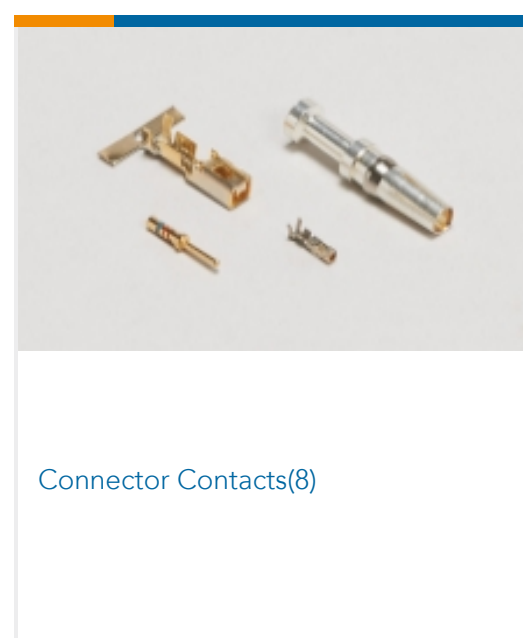
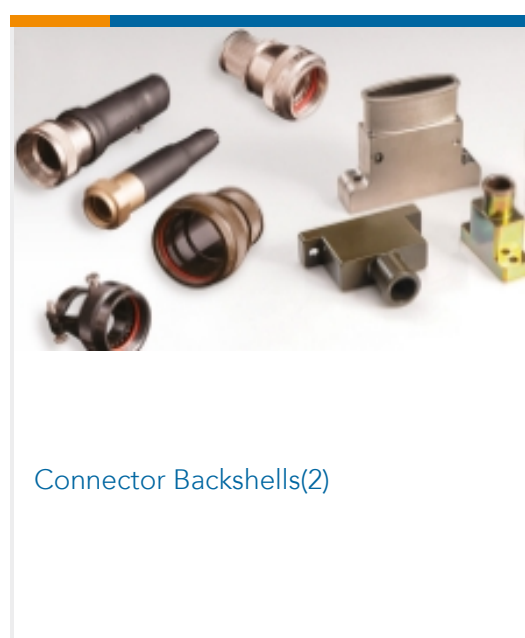



Rectangular Connector Locking(2)



Rectangular Power Connectors(244)

Customers Also Bought

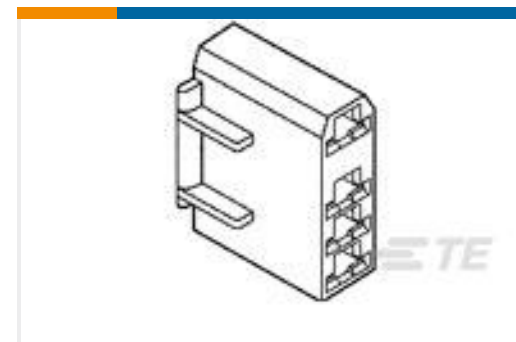
TE Part #172170-1
12 CIR UNIV M-N-L PLUGTE Part #770425-1
02P .093 COMM P&S PLUG .248CLTE Part #1-794374-1
SINGLE CIRCUIT MINI UMNL ASSYTE Part #520987-2
250 FASTON HSG. REC 4P NATURALTE Part #1379659-2
8W PLUG HOUSING ASSY GRAYTE Part #927155-1
2P MT-EDGE GEHTE Part #1379218-1
COVER FOR 5W MPQ+MQS HSGTE Part #2525596021
RBK-ILS-125-NR1-0-30MMTE Part #364226-E
SRCBUG A 2,54 2 5 CSI 112 E1 ADV J
2 324TE Part #926211-1
3P MT-EDGE GEH

Documents

Product Drawings

1 CIR UNIV M-N-L PLUG

English

CAD Files

3D PDF

3D

Customer View Model

ENG_CVM_CVM_172164-1_J.2d_dxf.zip



English

Customer View Model

[ENG_CVM_CVM_172164-1_J.3d_igs.zip](#)

English

Customer View Model

[ENG_CVM_CVM_172164-1_J.3d_stp.zip](#)

English

By downloading the CAD file I accept and agree to the [Terms and Conditions](#) of use.

Datasheets & Catalog Pages

[SOFT_SHELL_PIN_AND_SOCKET_CONNECTORS_CATALOG](#)

English

Product Specifications

[Engineering Report](#)

English

Product Environmental Compliance

[Product Compliance Document](#)

English

[Product Compliance Document](#)

English

Instruction Sheets

[Instruction Sheet \(U.S.\)](#)

English

[Instruction Sheet \(U.S.\)](#)

English

Agency Approvals

[Agency Approval Document](#)

English