



Alpha 4A

GPS Antenna



Key Features

- Adhesive or magnetic mountable
- 26db LNA gain
- Waterproof
- Compact size

General Description

The Alpha 4A is a compact, self adhesive, waterproof, GPS antenna.

It comes with a strong self-adhesive base that provides a firm fix to most flat surfaces. The antenna is well suited to outdoor environments that GPS applications are often subject to.

The built in Low Noise Amplifier (LNA) provides a 26dB gain for superior GPS performance; necessary for strong signal reception from visible satellites as well as influencing a shorter time for satellite fixing.

Additional Considerations

- Waterproof design which makes it ideal for mounting outdoors
- Operates with GPS receivers with built in LNA circuit on board

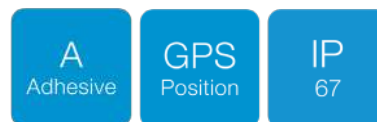



Alpha 4A

GPS Antenna

Dielectric Antenna

Centre Frequency:	1575.42+1 MHz
Polarization:	RHCP
Impedance:	50 Ohm
VSWR:	<1.5
Axial Ratio:	3 dB Max

Mechanical Specifications

Dimensions:	L38 x W34 x H13 mm
Cable:	RG174
Connector:	SMA Male
Material:	ABS
Mounting method:	Magnetic

GPS Antenna

LNA Gain:	26 dB +/-2 dB
Noise Figure:	<1.3
VSWR:	<2.0
Filter Insertion Loss:	<3 dB
Supply Voltage:	2.5 - 5 V DC
Current Consumption:	10 - 26 mA

Environmental Specifications

Operating Temperature:	-40 to +85 °C
Relative Humidity:	Up to 95 %

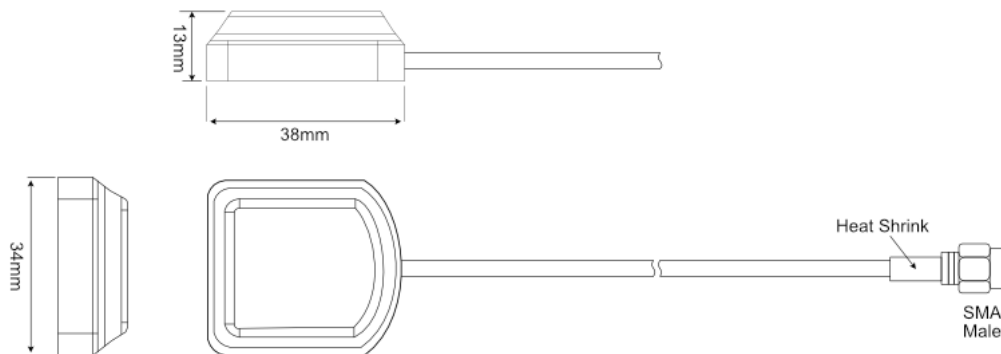



Return Loss

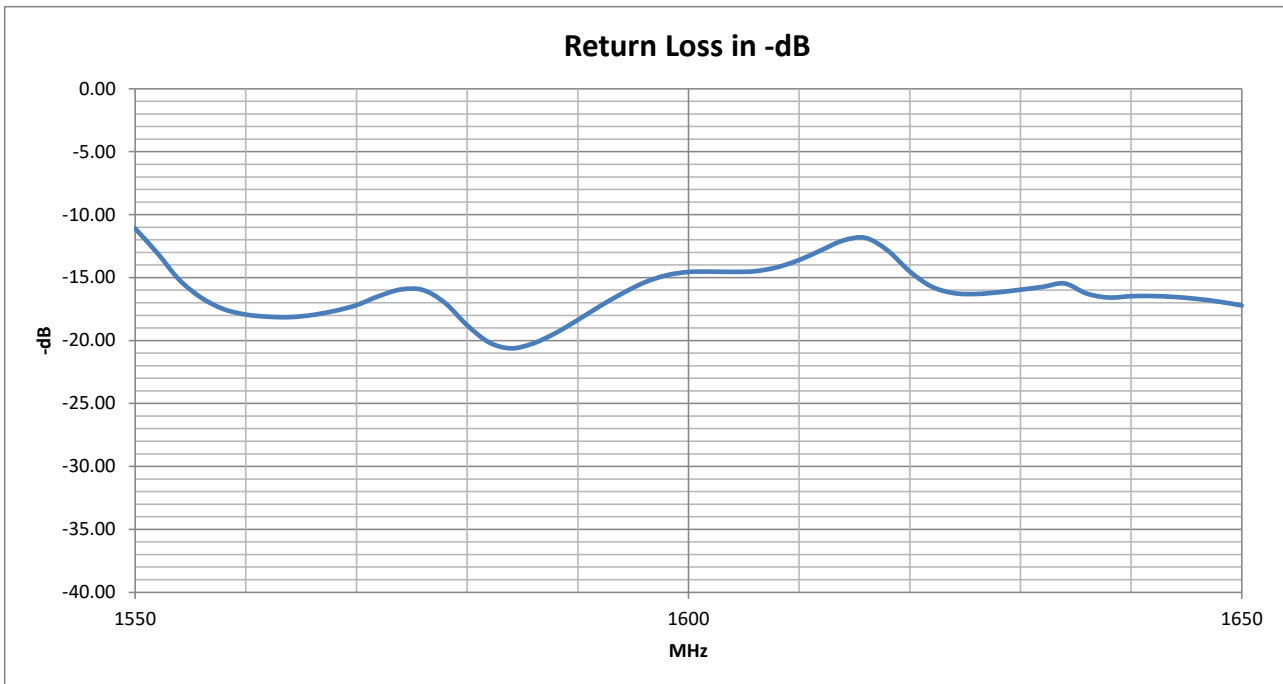

VSWR

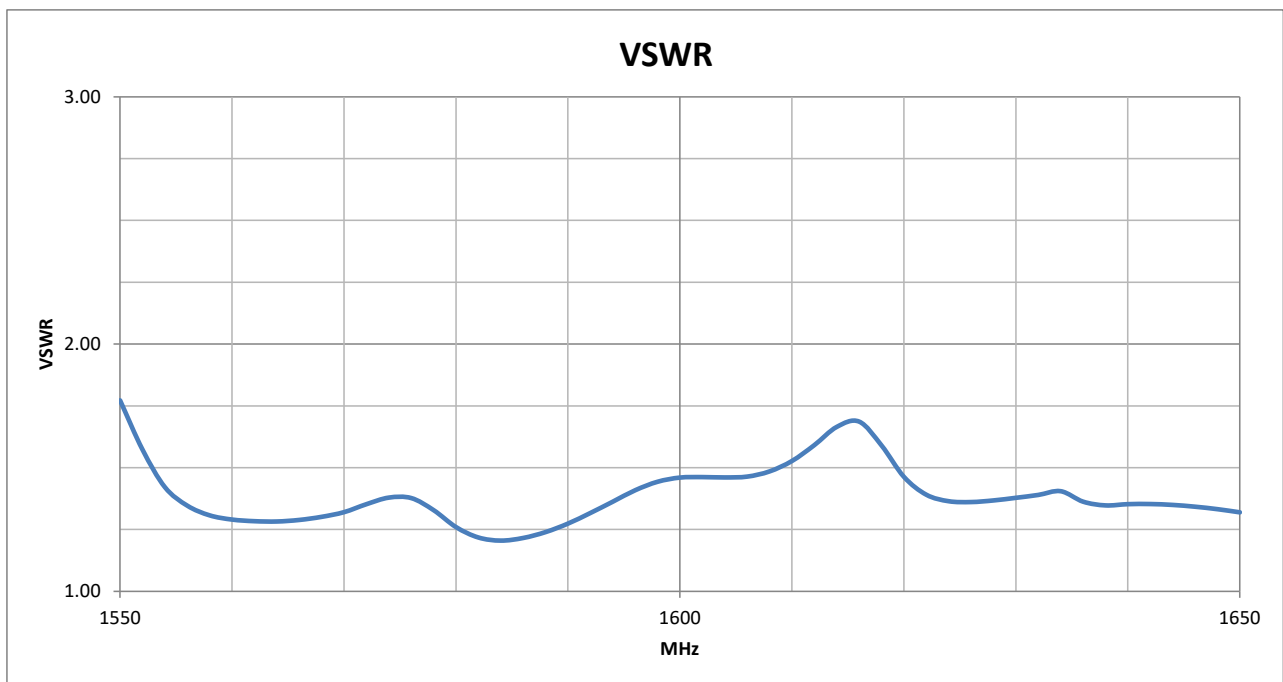



Gain

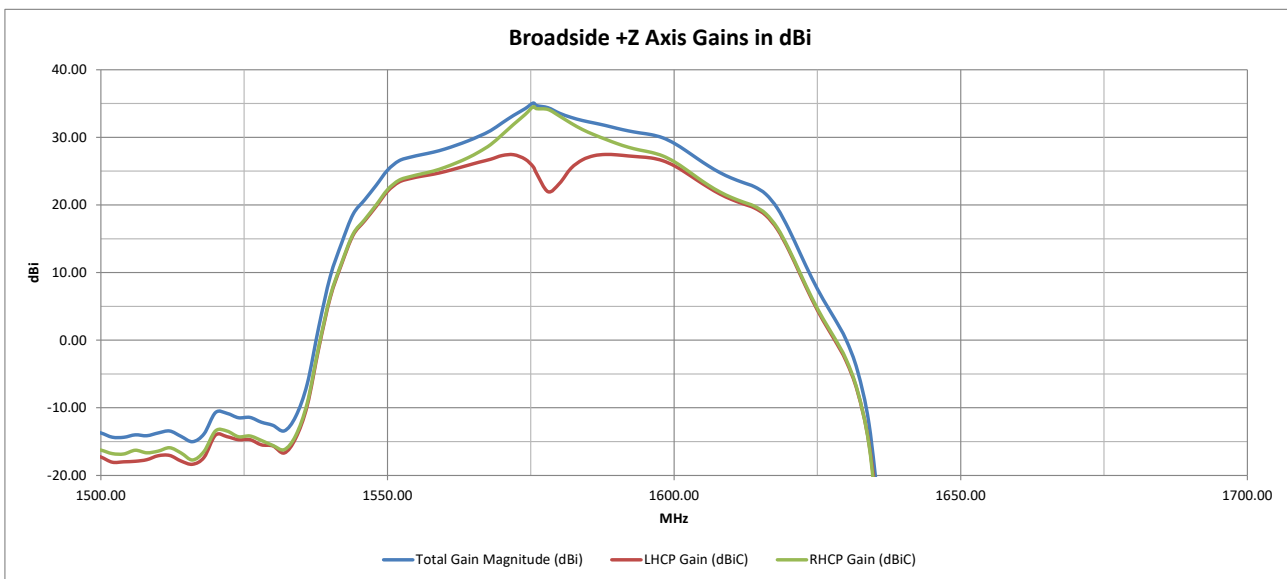
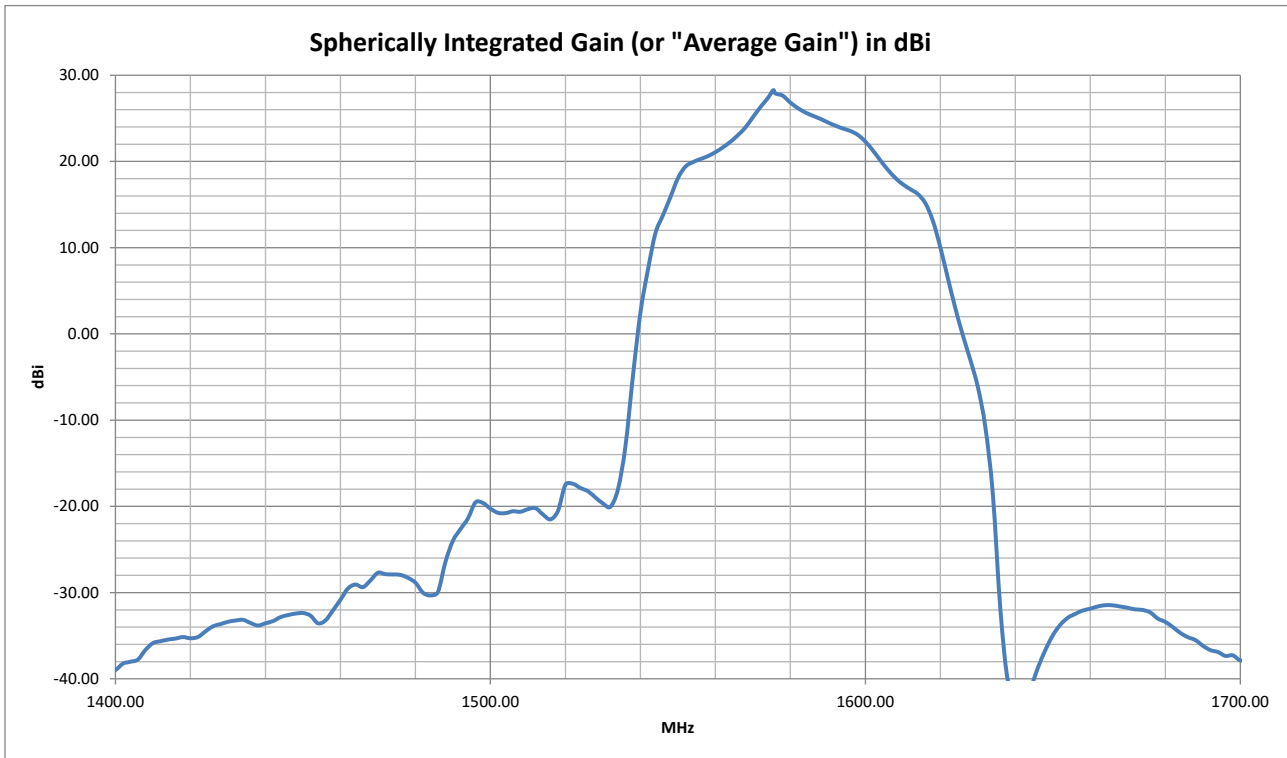



Alpha 4A

GPS Antenna

Radiation Plots tested with 1 m cable

1560 MHz XY

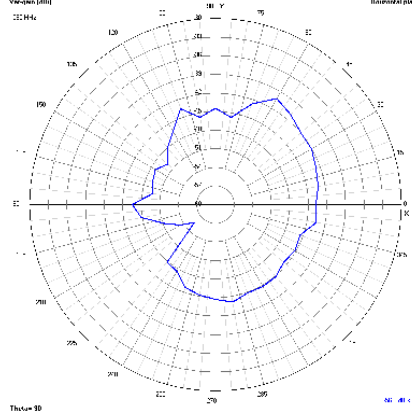

XZ

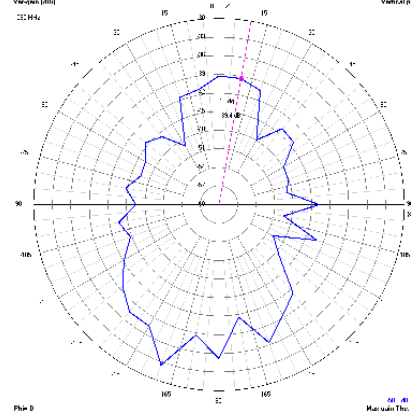

YZ

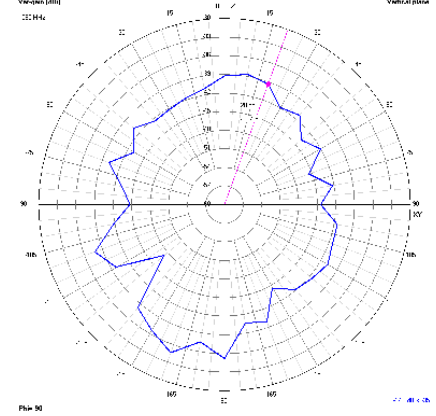

1580 MHz XY

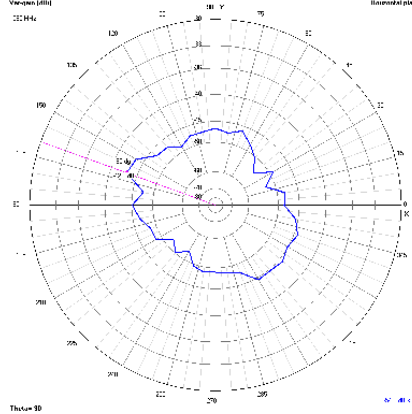

XZ

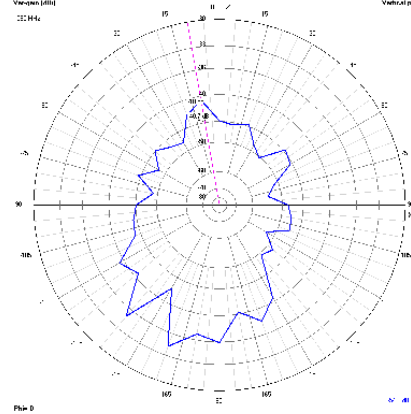

YZ

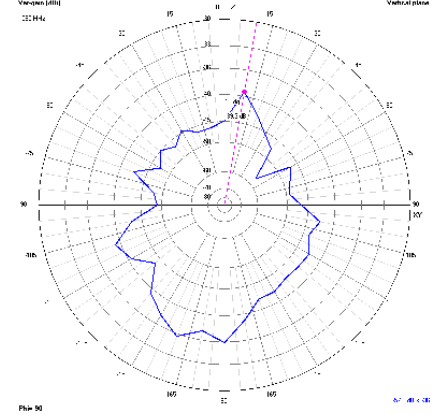



3D Radiation Plots tested with 1 m cable

1560 MHz

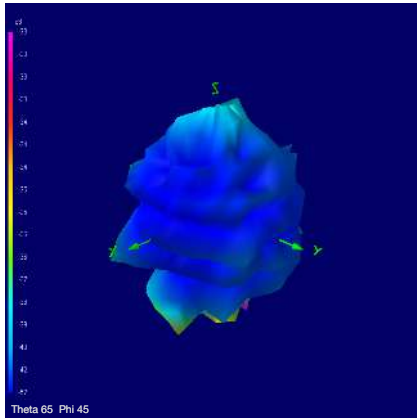

1580 MHz

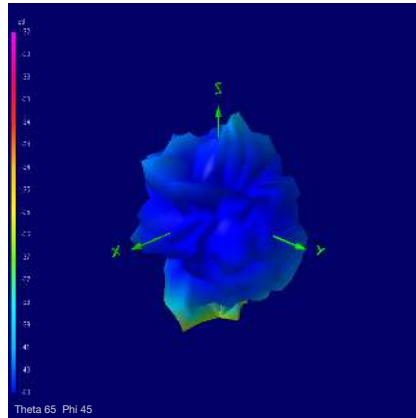

Ordering Details

Part number	Description
ALPHA4A/1M/SMAM/S/S/26	GPS ADHESIVE MOUNT ANTENNA SMA MALE CONNECTOR 1M CABLE
ALPHA4A/5M/SMAM/S/S/26	GPS ADHESIVE MOUNT ANTENNA SMA MALE CONNECTOR 5M CABLE