

ITEM	Q'TY	PART NUMBER	PART DESCRIPTION
1	1	H-220C-LP	T-1 (3mm) Bi-Level LED Holder, 90° Mount
2	2	3XX-S	T-1 (3mm) N-Flange Shouldered LED, See Following Pages

REV.	DESCRIPTION	DATE	APPROVED
A	Engineering Update w/o Changes	03/05/04	M. C.
B	Updated to Shouldered LEDs	04/01/08	M. C.
C	Locating Pin Suffix	04/03/12	T. Y.
D	Updated LED Offering List	06/25/12	T. Y.
E	Updated LED Optical Characteristics	09/15/15	J. C.

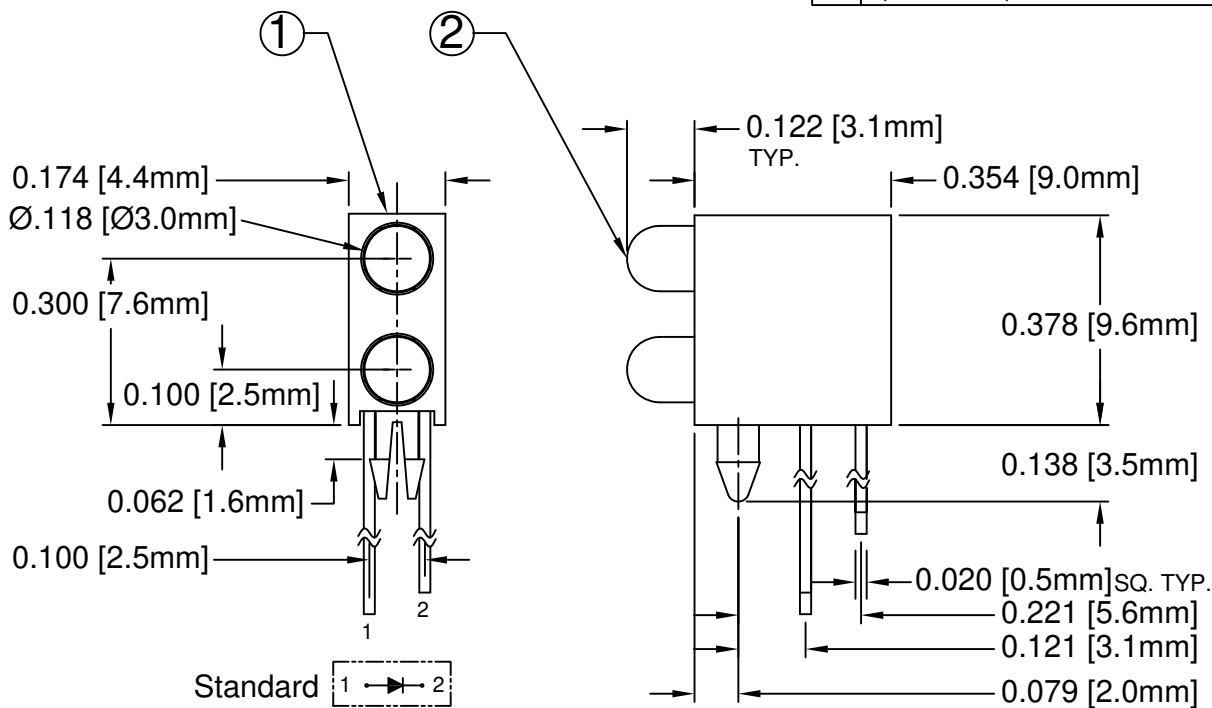

BI-COLOR POLARITY		
LED P/N	(1) Cathode	(2) Cathode
3BC	Green	Red
3BC-Y/G	Green	Yellow
3BC-R/Y	Yellow	Red
3BC-A/G	Green	Amber

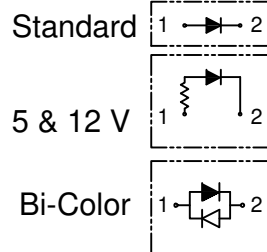
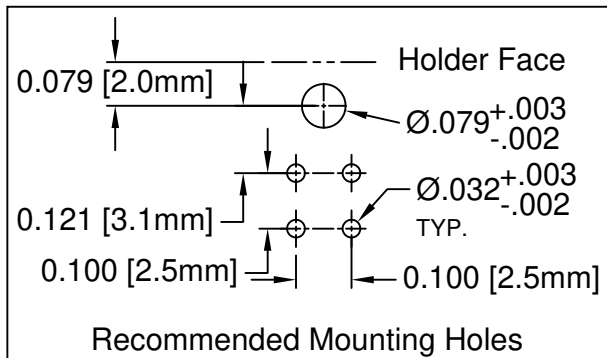

NOTE: P/N DESIGNATION

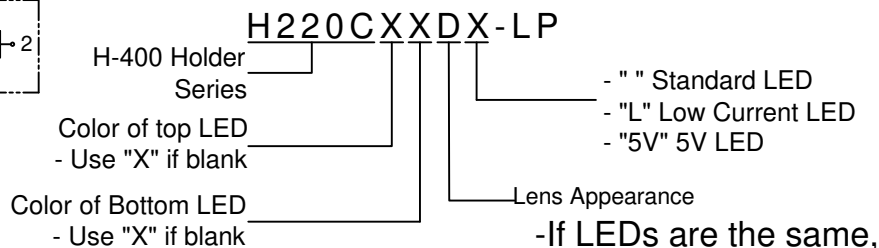

-If LEDs are the same, use e.g. H200CGD

All Green Diffused LEDs

## ABSOLUTE MAXIMUM RATINGS (Ta=25° C)

REVERSE VOLTAGE	5V
REVERSE CURRENT	100µA
OPERATING TEMPERATURE RANGE	-25° C - 85° C
STORAGE TEMPERATURE	-30° C - 100° C
LEAD SOLDERING TEMPERATURE(1/16" FROM BODY)	260° C FOR 5 SECONDS

STANDARD TOLERANCE (UNLESS OTHERWISE SPECIFIED)		BIVAR®	
DECIMALS	ANGULAR	4 THOMAS, IRVINE, CA. 92618	
.X ±.1	X° ±1°	TEL: (949) 951-8808 FAX: (949) 951-3974	
.XX ±.02		TITLE: T-1 (3MM) 90° BI-LEVEL LED LOCATOR PIN LED ASSY	
.XXX ±.010		PART NO: H220CXX-LP	
DESIGNED: T. Yin	DATE: 03/05/04	REVISION: E	
CHECKED: D. Green	DATE: 03/05/04	CAGE CODE : 32559 SHEET # 1 OF 4	
CAD GENERATED DOCUMENT. DO NOT MEASURE DRAWING.			

REV.	DESCRIPTION	DATE	APPROVED
	SEE SHEET#1.		

LED Assy. No.	Chip			Lens Appearance	Electro-Optical Data @ 20mA				Viewing Angle 2 θ ½ (Deg)	LED P/N
	Material	Peak Wave Length	Emitted Color		If (mA)	Vf (V)		Iv (mcd)		
					MAX	TYP	MAX	TYP		
H220CBWC-LP	GaN/SiC	430	BLUE	WATER CLEAR	25	4.0	4.5	25	30	3BWC-S
H220CBWD-LP	GaN/SiC	430	BLUE	DIFFUSED	25	4.0	4.5	10	40	3BWD-S
H220CBWT-LP	GaN/SiC	430	BLUE	TINTED	25	4.0	4.5	25	30	3BWT-S
H220CGC-LP	GaP/GaP	568	GREEN	WATER CLEAR	30	2.1	2.8	40	30	3GC-S
H220CGD-LP	GaP/GaP	568	GREEN	DIFFUSED	30	2.1	2.8	25	40	3GD-S
H220CGT-LP	GaP/GaP	568	GREEN	TINTED	30	2.1	2.8	40	30	3GT-S
H220CPGC-LP	GaP/GaP	555	PURE GREEN	WATER CLEAR	30	2.2	2.8	10	30	3PGC-S
H220CPGD-LP	GaP/GaP	555	PURE GREEN	DIFFUSED	30	2.2	2.8	5	40	3PGD-S
H220CPGT-LP	GaP/GaP	555	PURE GREEN	TINTED	30	2.2	2.8	10	30	3PGT-S
H220CYC-LP	GaAsP/GaP	590	YELLOW	WATER CLEAR	30	2.0	2.8	40	30	3YC-S
H220CYD-LP	GaAsP/GaP	590	YELLOW	DIFFUSED	30	2.0	2.8	20	40	3YD-S
H220CYT-LP	GaAsP/GaP	590	YELLOW	TINTED	30	2.0	2.8	40	30	3YT-S
H220CAC-LP	GaAsP/GaP	605	AMBER	WATER CLEAR	30	2.0	2.8	40	30	3AC-S
H220CAD-LP	GaAsP/GaP	605	AMBER	DIFFUSED	30	2.0	2.8	25	40	3AD-S
H220CAT-LP	GaAsP/GaP	605	AMBER	TINTED	30	2.0	2.8	40	30	3AT-S
H220CHC-LP	GaAsP/GaP	625	HE RED	WATER CLEAR	30	2.0	2.8	50	30	3HC-S
H220CHD-LP	GaAsP/GaP	625	HE RED	DIFFUSED	30	2.0	2.8	30	40	3HD-S
H220CHT-LP	GaAsP/GaP	625	HE RED	TINTED	30	2.0	2.8	50	30	3HT-S
H220CRC-LP	GaP/GaP	700	RED	WATER CLEAR	20	2.1	2.8	2.5	30	3RC-S
H220CRD-LP	GaP/GaP	700	RED	DIFFUSED	20	2.1	2.8	2	40	3RD-S
H220CRT-LP	GaP/GaP	700	RED	TINTED	20	2.1	2.8	2.5	30	3RT-S
H220CBC-A/G-LP	GaAsP/GaP	605	AMBER	DIFFUSED	30	2.0	2.8	6	45	3BC-A/G
	GaP/GaP	568	GREEN		30	2.1	2.8	6		
H220CBC-LP	GaAsP/GaP	625	RED	DIFFUSED	30	2.0	2.8	6	45	3BC
	GaP/GaP	568	GREEN		30	2.1	2.8	6		
H220CBC-R/Y-LP	GaAsP/GaP	625	RED	DIFFUSED	30	2.0	2.8	6	45	3BC-R/Y
	GaAsP/GaP	590	YELLOW		30	2.0	2.8	4		
H220CBC-Y/G-LP	GaAsP/GaP	590	YELLOW	DIFFUSED	30	2.0	2.8	4	45	3BC-Y/G
	GaP/GaP	568	GREEN		30	2.1	2.8	6		

STANDARD TOLERANCE ( UNLESS OTHERWISE SPECIFIED ) ±10% ALL VALUES <u>ANGULAR</u>		 <b>BIVAR</b> <sup>®</sup> 4 THOMAS, IRVINE, CA. 92618 TEL: (949) 951-8808    FAX: (949) 951-3974	
X° ± 5°			
DESIGNED: <b>T. Yin</b>		DATE: <b>03/05/04</b>	
CHECKED: <b>D. Green</b>		DATE: <b>03/05/04</b>	
TITLE: T-1 (3MM) 90° BI-LEVEL LED LOCATOR PIN LED ASSY		REVISION: <b>E</b>	
PART NO: <b>H220CXX-LP</b>		CAGE CODE : <b>32559</b> SHEET # <b>2 OF 4</b>	
CAD GENERATED DOCUMENT. DO NOT MEASURE DRAWING.			

REV.	DESCRIPTION	DATE	APPROVED
	SEE SHEET#1.		

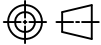

LED Assy. No.	Chip			Lens Appearance	Electro-Optical Data @ 20mA				Viewing Angle 2 θ ½ (Deg)	LED P/N	
	Material	Peak Wave Length	Emitted Color		If (mA)	Vf (V)		Iv (mcd)			
						MAX	TYP	MAX			TYP
H220CUBWC-LP	GaN/SiC	470	BLUE	WATER CLEAR	30	4.0	4.5	400	30	3UBWC-0.6K	
H220CSGC-LP	GaP/GaP	568	GREEN	WATER CLEAR	30	2.1	2.8	50	30	3SGC-S	
H220CSGD-LP	GaP/GaP	568	GREEN	DIFFUSED	30	2.1	2.8	30	40	3SGD-S	
H220CSGT-LP	GaP/GaP	568	GREEN	TINTED	30	2.1	2.8	50	30	3SGT-S	
H220CSYC-LP	GaAsP/GaP	590	YELLOW	WATER CLEAR	30	2.0	2.8	50	30	3SYC-S	
H220CSYD-LP	GaAsP/GaP	590	YELLOW	DIFFUSED	30	2.0	2.8	30	40	3SYD-S	
H220CSYT-LP	GaAsP/GaP	590	YELLOW	TINTED	30	2.0	2.8	50	30	3SYT-S	
H220CSAC-LP	AlGaInP	605	AMBER	WATER CLEAR	30	1.8	2.4	300	30	3SAC-S	
H220CSAD-LP	AlGaInP	605	AMBER	DIFFUSED	30	1.8	2.4	100	40	3SAD-S	
H220CSAT-LP	AlGaInP	605	AMBER	TINTED	30	1.8	2.4	300	30	3SAT-S	
H220CSRC-LP	GaAlAs/GaAs	645	SUPER RED	WATER CLEAR	30	1.7	2.4	60	30	3SRC-S	
H220CSRDLP	GaAlAs/GaAs	645	SUPER RED	DIFFUSED	30	1.7	2.4	40	40	3SRD-S	
H220CSRTL	GaAlAs/GaAs	645	SUPER RED	TINTED	30	1.7	2.4	60	30	3SRT-S	
H220CUGC-LP	AlGaInP	570	GREEN	WATER CLEAR	30	2.1	2.4	200	30	3UGC-S	
H220CSUGC-LP	AlGaInP	570	GREEN	WATER CLEAR	30	2.1	2.4	300	30	3SUGC-S	
H220CUYC-LP	AlGaInP	590	YELLOW	WATER CLEAR	30	2.0	2.4	300	30	3UYC-S	
H220CSUYC-LP	AlGaInP	590	YELLOW	WATER CLEAR	30	2.0	2.4	400	30	3SUYC-S	
H220CUUYC-LP	AlGaInP	590	YELLOW	WATER CLEAR	30	2.0	2.4	600	30	3UUYC-S	
H220CUOC-LP	AlGaInP	625	ORANGE	WATER CLEAR	30	1.8	2.4	300	30	3UOC-S	
H220CSUOC-LP	AlGaInP	625	ORANGE	WATER CLEAR	30	1.8	2.4	400	30	3SUOC-S	
H220CURC-LP	GaAlAs/GaAs	645	RED	WATER CLEAR	30	1.7	2.4	200	30	3URC-S	
H220CSURC-LP	AlGaInP	640	RED	WATER CLEAR	30	1.8	2.4	200	30	3SURC-S	
H220CUWC-LP	InGaN/Sapphire	6500K	WHITE	WATER CLEAR	30	3.2	3.6	5000	30	3UWC1.030C	

STANDARD TOLERANCE ( UNLESS OTHERWISE SPECIFIED ) ±10% ALL VALUES      ANGULAR X° ± 5°		 <b>BIVAR</b> <sup>®</sup> 4 THOMAS, IRVINE, CA. 92618 TEL: (949) 951-8808    FAX: (949) 951-3974	
			
DESIGNED: <b>T. Yin</b>	DATE: <b>03/05/04</b>	<b>TITLE:</b> T-1 (3MM) 90° BI-LEVEL LED LOCATOR PIN LED ASSY	
CHECKED: <b>D. Green</b>	DATE: <b>03/05/04</b>	<b>PART NO:</b> H220CXX-LP	<b>REVISION:</b> E
		<b>CAGE CODE :</b> 32559	<b>SHEET #</b> 3 OF 4
CAD GENERATED DOCUMENT. DO NOT MEASURE DRAWING.			

REV.	DESCRIPTION	DATE	APPROVED
	SEE SHEET#1.		

LED Assy. No.	Chip			Lens Appearance	Absolute Max. Ratings			Electro-Optical Data @ 2mA			Viewing Angle 2 θ ½ (Deg)	LED P/N
	Material	Peak Wave Length λp(nm)	Emitted Color		Pd (mW)	If (mA)	Peak If(mA)	Vf (V)		Iv (mcd)		
								TYP	MAX	TYP		
H220CBWDL-LP	GaN/siC	430	BLUE	DIFFUSED	20	7	-	3.8	4.2	2.5	40	3BWDL-S
H220CGDL-LP	GaP/GaP	568	GREEN	DIFFUSED	10	7	-	2.1	2.6	2.0	40	3GDL-S
H220CPGDL-LP	GaP/GaP	555	PURE GREEN	DIFFUSED	10	7	-	2.1	2.6	0.2	40	3PGDL-S
H220CYDL-LP	GaAsP/GaP	590	YELLOW	DIFFUSED	10	7	-	2.0	2.6	2.0	40	3YDL-S
H220CADL-LP	GaAsP/GaP	605	AMBER	DIFFUSED	10	7	-	2.0	2.6	4.0	40	3ADL-S
H220CHDL-LP	GaAsP/GaP	625	HE RED	DIFFUSED	10	7	-	2.0	2.6	2.5	40	3HDL-S
H220CRDL-LP	GaP/GaP	700	RED	DIFFUSED	10	7	-	2.1	2.6	0.5	40	3RDL-S
H220CSRDL-LP	GaAlAs/GaAs	645	RED	DIFFUSED	10	7	-	2.0	-	8.0	40	3SRDL-S

LED Assy. No.	Peak Wave Length λp(nm)	Emitted Color	Lens Appearance	Electro-Optical Data				Viewing Angle 2 θ½ (Deg)	LED P/N
				If (mA)	Vf (V)		Iv (mcd)		
					MAX	TYP	MAX		
<b>5 Volt</b>				<b>Data @ 5V</b>					
H220CBWD5V-LP	BLUE	430	DIFFUSED	-	-	5	10	35	3BWD5V-S
H220CGC5V-LP	GREEN	568	WATER CLEAR	-	-	5	40	20	3GC5V-S
H220CGD5V-LP	GREEN	568	DIFFUSED	-	-	5	25	35	3GD5V-S
H220CGT5V-LP	GREEN	568	TINTED	-	-	5	40	20	3GT5V-S
H220CAD5V-LP	AMBER	605	DIFFUSED	-	-	5	25	35	3AD5V-S
H220CHD5V-LP	HE RED	625	DIFFUSED	-	-	5	30	35	3HD5V-S
H220CRD5V-LP	RED	700	DIFFUSED	-	-	5	2	35	3RD5V-S
H220CYD5V-LP	YELLOW	590	DIFFUSED	-	-	5	20	35	3YD5V-S
<b>12 Volt</b>				<b>Data @ 12V</b>					
H220CGC12V-LP	GREEN	568	WATER CLEAR	-	-	12	40	20	3GC12V-S
H220CGD12V-LP	GREEN	568	DIFFUSED	-	-	12	25	35	3GD12V-S
H220CHC12V-LP	HE RED	625	WATER CLEAR	-	-	12	50	20	3HC12V-S
H220CHD12V-LP	HE RED	625	DIFFUSED	-	-	12	30	35	3HD12V-S
H220CRC12V-LP	RED	700	WATER CLEAR	-	-	12	6	20	3RC12V-S
H220CRD12V-LP	RED	700	DIFFUSED	-	-	12	2	35	3RD12V-S
H220CYC12V-LP	YELLOW	590	WATER CLEAR	-	-	12	40	20	3YC12V-S
H220CYD12V-LP	YELLOW	590	DIFFUSED	-	-	12	25	35	3YD12V-S

STANDARD TOLERANCE ( UNLESS OTHERWISE SPECIFIED ) ±10% ALL VALUES		 <b>BIVAR</b> <sup>®</sup> 4 THOMAS, IRVINE, CA. 92618 TEL: (949) 951-8808 FAX: (949) 951-3974	
ANGULAR X° ± 5°			
		<b>TITLE:</b> T-1 (3MM) 90° BI-LEVEL LED LOCATOR PIN LED ASSY	
DESIGNED: <b>T. Yin</b>	DATE: <b>03/05/04</b>	<b>PART NO:</b> H220CXX-LP	REVISION: <b>E</b>
CHECKED: <b>D. Green</b>	DATE: <b>03/05/04</b>	<b>CAGE CODE :</b> 32559	<b>SHEET #</b> 4 OF 4
CAD GENERATED DOCUMENT. DO NOT MEASURE DRAWING.			