



Carling Technologies®
 /// NOW PART OF



Littelfuse®

611/621-Series

Small-Sized Rocker Switches

PRODUCT WEBPAGE

request sample, configure part



The 611/621-Series small-size, sleek styling, actuator and termination choices make this switch a cost effective solution to most any switching need. International approvals, single or double pole circuitry, and ratings to 11A 125VAC further the broad appeal of this product family.

1-2
Poles

.4-11
Amps

125-250
VAC

12-24
VDC

Typical Applications

- Appliances
- Audio-Visual
- Power Supplies
- Medical Equipment

Tech Specs

Dielectric Strength

UL/CSA: 1000V - live to dead metal parts & opposite polarity
 VDE: 4000V - live to dead metal parts; 1250V opposite polarity & across open contacts

Electrical Life

50,000 cycles- single pole
 50,000 cycles- double pole

Operating Temperature

32°F to 185°F (0°C to 85°C)

Ordering Scheme

Sample Part Number **62116919 - 0 - 9 - V**

Selection 1 2 3 4

1. SERIES

	187 Tabs ⁴	.080 Solder Lugs	PC Terms	Wire Leads	PC Front Mount	PC Back Mount	.187 Solder Lugs
Single Pole; 4A 250VAC; 8A 125VAC; 6(4) A 250V ⁴							
ON-NONE-OFF	62116919	-	-	62111914	62111918 ⁶	62111917 ⁶	62111916
ON-NONE-ON	62116929	62116421	62111422	62111924	62111928 ⁶	62111927 ⁶	62111926
ON-OFF-ON ³	-	62111461	62111462	62111263 ⁷	-	-	-
ON-NONE-(ON) ³	-	62111431	62111432	62111233 ⁷	-	-	-
ON-OFF-(ON) ³	-	62111471	62111472	62111273 ⁷	-	-	-
(ON)-OFF-(ON) ³	-	62111481	62111482	62111283 ⁷	-	-	-
Double Pole; 4A 250VAC; 8A 125VAC; 6(4) A 250V ⁴							
ON-NONE-OFF	62115919	-	-	62112914	62112918 ⁶	62112917 ⁶	62112916
ON-NONE-ON	62115929	62112421	62112422	62112924	62112928 ⁶	62112927 ⁶	62112926
ON-OFF-ON ³	-	62112461	62112462	62112263 ⁷	-	-	-
ON-NONE-(ON) ³	-	62112431	62112432	62112233 ⁷	-	-	-
ON-OFF-(ON) ³	-	62112471	62112472	62112273 ⁷	-	-	-
(ON)-OFF-(ON) ³	-	62112481	62112482	62112283 ⁷	-	-	-

2. TERMINAL SEALING

- 0** None
- E** Epoxy sealed terminals

Notes:

- 1 Base part number specifies black rocker with black bezel. To specify paddle actuator change 2nd digit from 2 to 1. ex: 61115919 = black paddle with black bezel.
- 2 For additional ratings & colors, consult factory.
- 3 Dry circuit rating is available, consult factory.
- 4 Not available with 6(4) A 250 V rating or VDE approval.
- 5 6(4) A 250V VDE approved rating available with On-none-Off and On-none-On circuits only.
- 6 Available with visi-rocker option only.
- 7 Consult factory for PC footprint.
- 8 Rated 2A 250VAC, 5A 125 VAC resistive.
- () Indicates momentary function.

3. ROCKER LEGEND

	molded in ⁵	hot stamp
NO LEGEND	0	0
Off-On vertical	n/a	A
Off-On horizontal	n/a	B
I-O horizontal	8	D
I-O vertical	9	E
O on rocker radius	n/a	F (Indicates ON)

4. VISI-ROCKER END COLOR

- N** n/a
- V** visi-red
- W** visi-white

[Configure Complete Part Number >](#)

[Browse Standard Parts >](#)

Dimensional Specs

inches [millimeters]

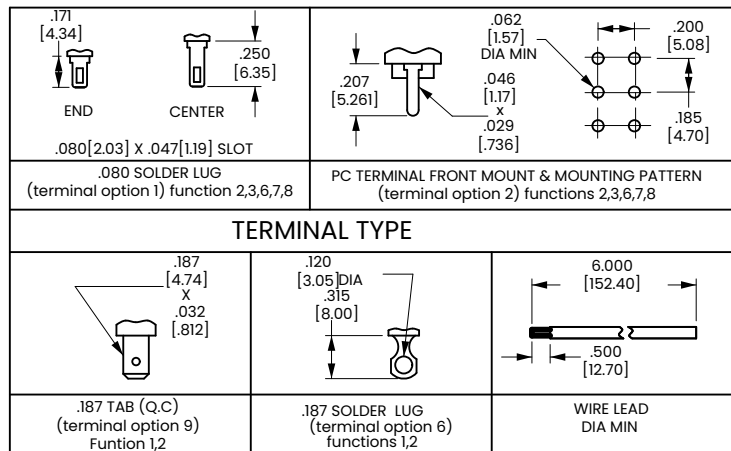
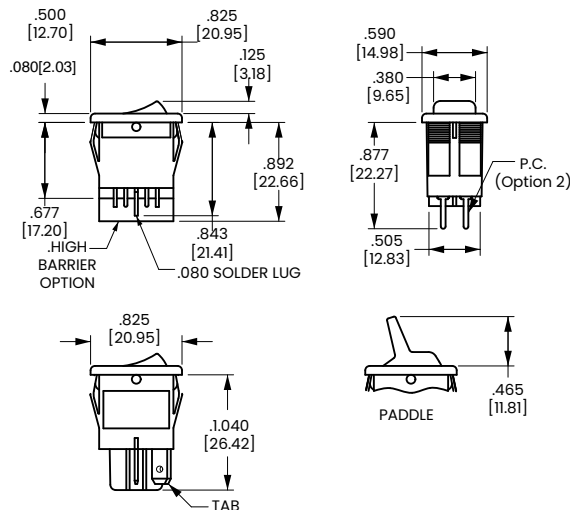

PANEL THICKNESS	X	Y	
.030 [0.762] - .060 [1.52]	.508 [12.90]	.756 [19.20]	
.060 [1.52] - .093 [2.36]	.508 [12.90]	.764 [19.40]	
.093 [2.36] - .156 [3.96]	.508 [12.90]	.780 [19.81]	

Authorized Sales Representatives and Distributors

Click on a region of the map below to find your local representatives and distributors or visit www.carlingtech.com/findarep.



About Carling

Founded in 1920, Carling Technologies is a leading manufacturer of electrical and electronic switches and assemblies, circuit breakers, electronic controls, power distribution units, and multiplexed power distribution systems. With six ISO9001 and IATF16949 registered manufacturing facilities and technical sales offices worldwide, Carling Technologies Sales, Service and Engineering teams do much more than manufacture electrical components, they engineer powerful solutions! To learn more about Carling please visit www.carlingtech.com/company-profile.

To view all of Carling's environmental, quality, health & safety certifications please visit www.carlingtech.com/environmental-certifications.

© Carling Technologies, Inc.

3. Carling, Visi-Rocker are registered trademarks of Carling Technologies, Inc. in the U.S. and other countries.