

# General Specifications

## Electrical Capacity (Resistive Load)

**Low/Logic Level:** 50mA @ 24V DC maximum for Standard Operating Force models  
125mA @ 24V DC maximum for High Operating Force models

## Other Ratings

	Standard Operating Force	High Operating Force
<b>Contact Resistance:</b>	50 milliohms maximum	50 milliohms maximum
<b>Insulation Resistance:</b>	500 megohms minimum @ 250V DC	500 megohms minimum @ 250V DC
<b>Dielectric Strength:</b>	250V AC minimum for 1 minute minimum	250V AC minimum for 1 minute minimum
<b>Mechanical Life:</b>	5,000,000 operations minimum	1,000,000 operations minimum
<b>Electrical Life:</b>	5,000,000 operations minimum	1,000,000 operations minimum
<b>Nominal Operating Force:</b>	1.76N for JB15L	2.65N for JB15HL & JB15HB
<b>Total Travel:</b>	.010" (.254mm)	.012" (.300mm)

## Materials & Finishes

<b>Actuator:</b>	Polyacetal for Short; Glass fiber reinforced PBT for Extended
<b>Case:</b>	Glass fiber reinforced polyamide (UL94V-0)
<b>Seal:</b>	Nitrile butadiene rubber
<b>Base:</b>	Glass fiber reinforced PBT (UL94V-0)
<b>Movable Contacts:</b>	Stainless steel
<b>Stationary Contacts:</b>	Brass with silver plating
<b>Terminals:</b>	Brass with silver plating

## Environmental Data

<b>Operating Temperature Range:</b>	-25°C through +70°C (-13°F through +158°F)
<b>Humidity:</b>	90 ~ 95% humidity for 240 hours @ 40°C (104°F)
<b>Vibration:</b>	10 ~ 55Hz with peak-to-peak amplitude of 1.5mm traversing the frequency range & returning in 1 minute; 3 right angled directions for 2 hours
<b>Shock:</b>	50G (490m/s <sup>2</sup> ) acceleration (tested in 6 right angled directions, with 5 shocks in each direction)

## PCB Processing

<b>Soldering:</b>	Wave Soldering recommended. See Profile A in Supplement section. Manual Soldering: See Profile A in Supplement section.
<b>Cleaning:</b>	Automated cleaning. See Cleaning specifications in Supplement section.

## Standards & Certifications

<b>Flammability Standards:</b>	UL94V-0 rated case & base The JB Series tactiles have not been tested for UL recognition or CSA certification. These switches are designed for use in a low-voltage, low-current, logic-level circuit. When used as intended in a logic-level circuit, the results do not produce hazardous energy.
--------------------------------	--

# Distinctive Characteristics

Choice of dimensions from PCB to top of cap adds to design flexibility.

Bright, full-face illumination with red, green, or yellow LEDs for attractive, functional panel layouts.

Higher operating force type provides more pronounced operating feel.

Dome contact gives crisp tactile feedback to positively indicate circuit transfer and assures high reliability and long life of up to 5,000,000 operations.

Rubber seal construction prevents contact contamination and allows automated soldering and cleaning.

Slanted terminals provide a spring type action which ensures secure mounting and prevents dislodging during wave soldering.

Molded-in terminals are part of the sealed construction which allows automated soldering and cleaning.

Terminal spacing conforms to standard .100" (2.54mm) PCB grid.

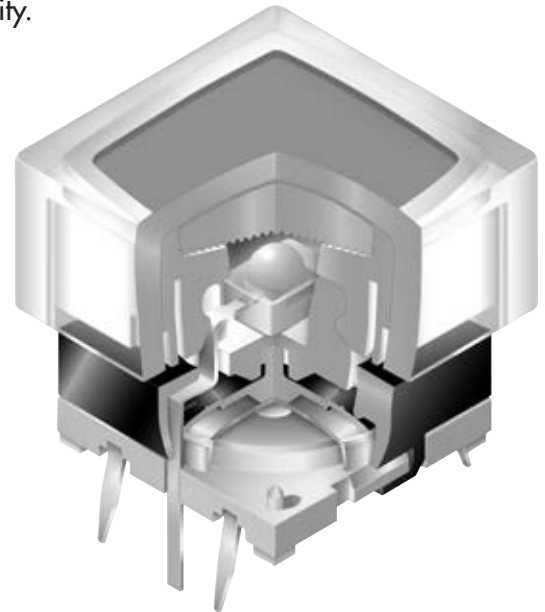

Actual Size



## Common Bus Matrix

These single pole, single throw switches can be used in a keyboard matrix and, using strapped terminals, achieve a common bus electrical configuration on a single-sided PC board.

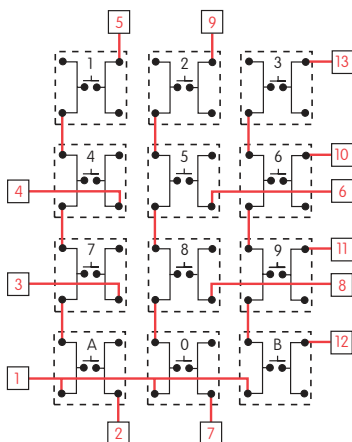

		PC Terminations												
		1	2	3	4	5	6	7	8	9	10	11	12	13
Keys (Switches)	1													
	2													
	3													
	4													
	5													
	6													
	7													
	8													
	9													
	0													
	A													
B														

● = ON

## X-Y Matrix

These single pole, single throw switches can be arranged on a single-sided PC board matrix with strapped terminals to achieve an X-Y type electrical interconnection.

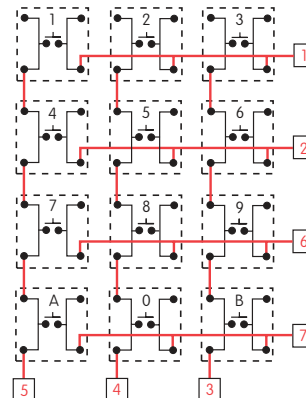

		PC Terminations						
		1	2	3	4	5	6	7
Keys (Switches)	1							
	2							
	3							
	4							
	5							
	6							
	7							
	8							
	9							
	0							
	A							
B								

● = ON

Red = PCB Trace    Black = Switch Circuit

- Toggles
- Rockers
- Pushbuttons
- Illuminated PB
- Programmable
- Keylocks
- Rotaries
- Slides
- J** Tactiles
- Tilt
- Touch
- Indicators
- Accessories
- Supplement

### TYPICAL SWITCH ORDERING EXAMPLE

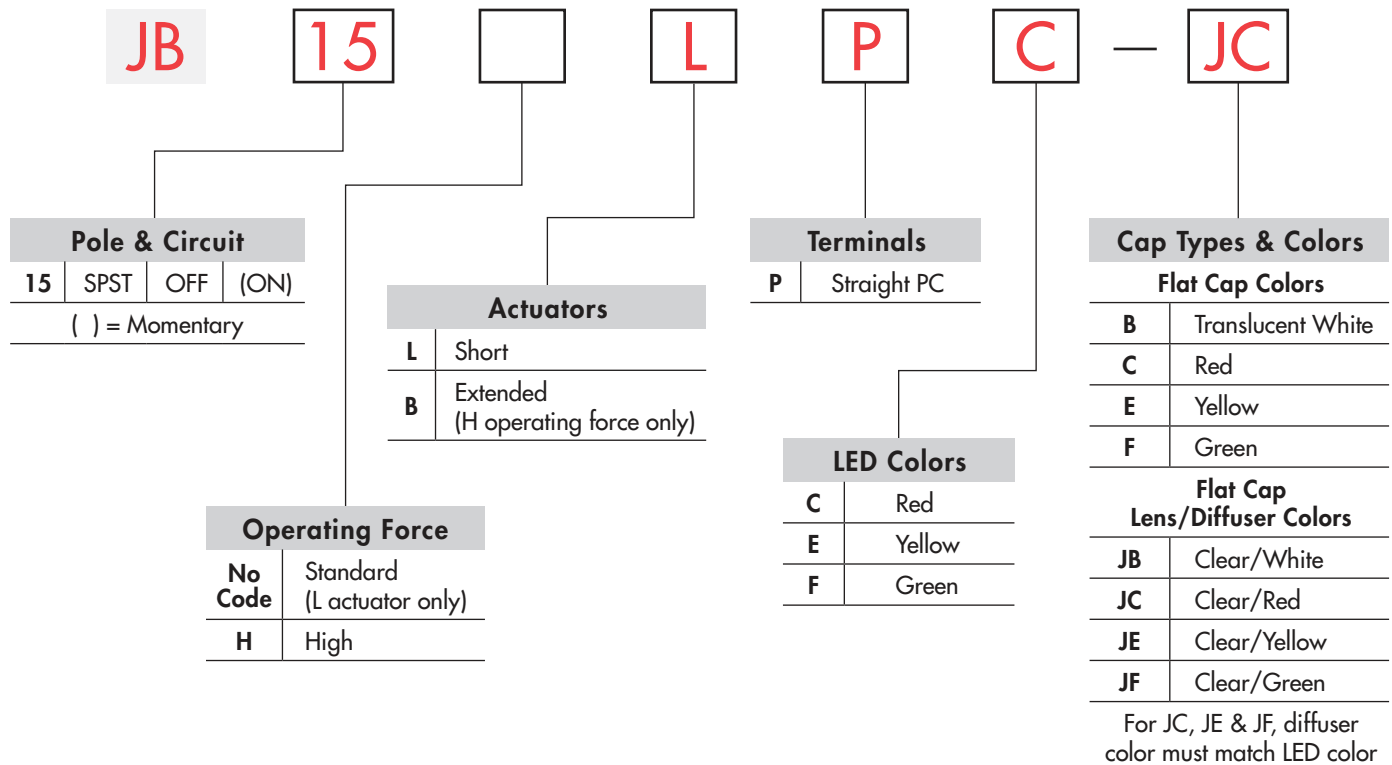

### DESCRIPTION FOR TYPICAL ORDERING EXAMPLE

**JB15LPC-JC**



Framed Cap Button/Frame Colors	
BB	White/White
BC	White/Red
BE	White/Yellow
BF	White/Green
BH	White/Gray

### POLE & CIRCUIT

Pole & Throw	Model	Actuator Position ( ) = Momentary		Switch Throw & Schematic	LED Schematic	Notes: Terminal numbers are shown on switch. LED circuit is isolated & requires external power source.
		Normal	Down			
SPST	JB15	OFF	(ON)			

## OPERATING FORCE

**No Code**

**Standard Nominal Operating Force**  
1.76N

Available with short actuator only (code L)

**H**

**High Nominal Operating Force**  
2.65N

Available with both short and extended actuators

## ACTUATORS

**L**

**Short Actuator**

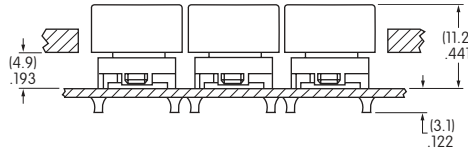
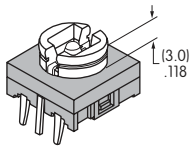

Custom keyboards can be designed with caps installed through a panel cutout (illustration with cap AT4060).

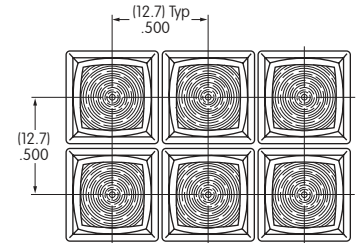

**B**

**Extended Actuator**

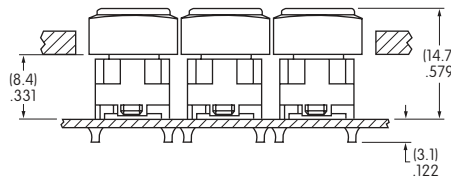
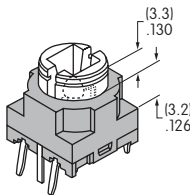

Custom keyboards can be designed with caps installed through a panel cutout (illustration with cap AT4076).

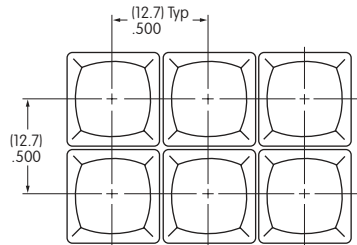

High operating force only

## TERMINALS

**P**

**Straight PC Terminals**

Further details in Typical Switch Dimensions

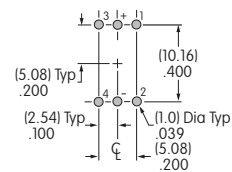
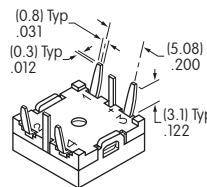

## LED COLORS & SPECIFICATIONS

LEDs are supplied as an integral part of illuminated devices and are not available separately.

LED polarity markings are on the bottom of the switch.

The electrical specifications shown here are determined at a basic temperature of 25°C.

If the source voltage exceeds the rated voltage, a ballast resistor is required.

The resistor value can be calculated by using the formula in the Supplement section.

		<b>C</b>	<b>E</b>	<b>F</b>
Color		Red	Yellow	Green
Maximum Forward Current	$I_{FM}$	30mA	20mA	30mA
Typical Forward Current	$I_F$	10mA	10mA	10mA
Forward Voltage	$V_F$	1.8V	2.0V	2.1V
Maximum Reverse Voltage	$V_{RM}$	5V	5V	5V
Current Reduction Rate Above 25°C	$\Delta I_F$	* 0.50mA/°C	* 0.33mA/°C	* 0.50mA/°C
Ambient Temperature Range		-25°C ~ +70°C		

\* Applies to temperatures above 50°C

## SNAP-ON CAPS

### AT4135 Flat

Cap Color Codes:

- |          |                   |          |        |
|----------|-------------------|----------|--------|
| <b>B</b> | Translucent White | <b>E</b> | Yellow |
| <b>C</b> | Red               | <b>F</b> | Green  |

Material: Polycarbonate    Finish: Frosted

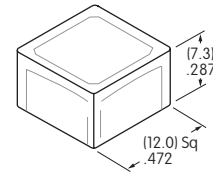

### AT4060 Flat

Lens/Diffuser Color Codes:

- |           |                         |
|-----------|-------------------------|
| <b>JB</b> | Clear/Translucent White |
| <b>JC</b> | Clear/Red               |
| <b>JE</b> | Clear/Yellow            |
| <b>JF</b> | Clear/Green             |

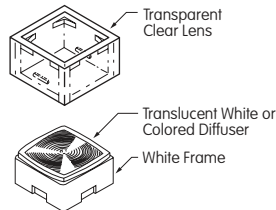
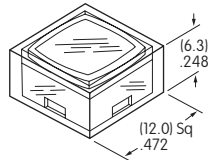

### Framed: AT4076 Button with Frame

Translucent Button/Frame Color Codes:

- |           |              |
|-----------|--------------|
| <b>BB</b> | White/White  |
| <b>BC</b> | White/Red    |
| <b>BE</b> | White/Yellow |
| <b>BF</b> | White/Green  |
| <b>BH</b> | White/Gray   |

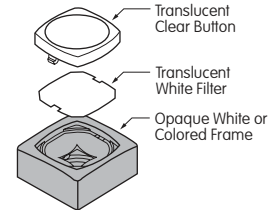
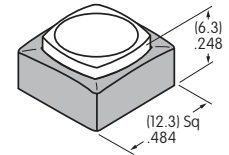

Material: Polycarbonate    Lens Finish: Glossy    Material: Polycarbonate    Button Finish: Frosted

## TYPICAL SWITCH DIMENSIONS

### Flat Snap-on Cap

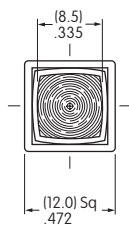

**Short Actuator**

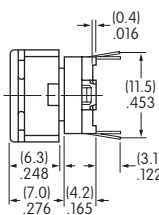

**Extended Actuator**

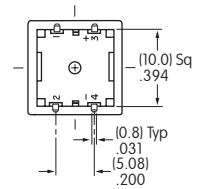
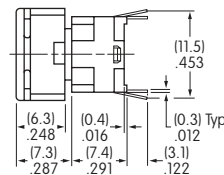

**JB15LPC-JC**

Spring action terminals conform to .100" (2.54mm) PCB spacing

### Framed Snap-on Cap

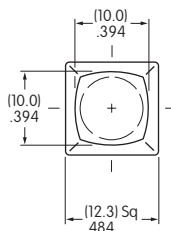

**Short Actuator**

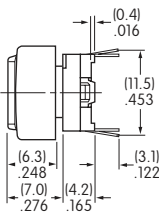

**Extended Actuator**

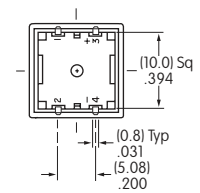
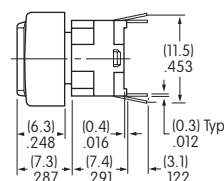

**JB15HBPC-BC**

Spring action terminals conform to .100" (2.54mm) PCB spacing

Toggles  
Rockers  
Pushbuttons  
Illuminated PB  
Programmable  
Keylocks  
Rotaries  
Slides  
Tactiles  
Tilt  
Touch  
Indicators  
Accessories  
Supplement

**LEGENDS**

NKK Switches can provide custom legends for caps. Contact factory for more information.

**Suggested Printable Area for Cap, Lens, or Button**

**Recommended Methods:**

Laser Etch, Screen Print or Pad Print

Laser Etch or Pad Print

Epoxy based ink is recommended.



Epoxy based ink is recommended.

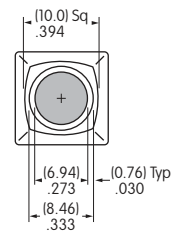
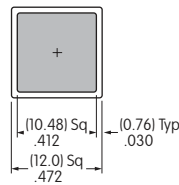
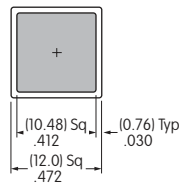

Shaded areas are printable areas.

**Suggested Printable Area for Film Insert**

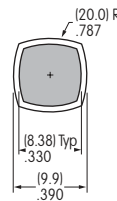
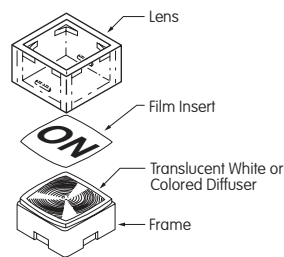

Shaded area is printable area.

Film Insert: Clear Polyester 7 mil maximum thickness