

# Highly Integrated Quasi-Resonant Current Mode PWM Controller

## FAN6300A / FAN6300H

The highly integrated FAN6300A/H of PWM controller provides several features to enhance the performance of flyback converters. FAN6300A is applied on quasiresonant flyback converters where maximum operating frequency is below 100 kHz. FAN6300H is suitable for high-frequency operation (up to 190 kHz). A built-in HV startup circuit can provide more startup current to reduce the startup time of the controller. Once the  $V_{DD}$  voltage exceeds the turn-on threshold voltage, the HV startup function is disabled immediately to reduce power consumption. An internal valley voltage detector ensures power system operates at quasi-resonant operation over a wide-range of line voltage and any load conditions, as well as reducing switching loss to minimize switching voltage on drain of power MOSFET.

To minimize standby power consumption and light-load efficiency, a proprietary green-mode function provides off-time modulation to decrease switching frequency and perform extended valley voltage switching to keep to a minimum switching voltage. The operating frequency is limited by minimum  $t_{OFF}$  time, which is 38  $\mu$ s to 8  $\mu$ s in FAN6300A and 13  $\mu$ s to 3  $\mu$ s in FAN6300H, so FAN6300H can operate at higher switching frequency than FAN6300A.

FAN6300A/H controller also provides many protection functions. Pulse-by-pulse current limiting ensures the fixed-peak current limit level, even when a short circuit occurs. Once an open-circuit failure occurs in the feedback loop, the internal protection circuit disables PWM output immediately. As long as  $V_{DD}$  drops below the turn-off threshold voltage, the controller also disables PWM output. The gate output is clamped at 18 V to protect the power MOS from high gate-source voltage conditions. The minimum  $t_{OFF}$  time limit prevents the system frequency from being too high. If the DET pin triggers OVP, internal OTP is triggered and the power system enters latch-mode until AC power is removed.

The FAN6300A/H controller is available in the 8-pin SOIC8 package.

### Features

- High-Voltage Startup
- Quasi-Resonant Operation
- Cycle-by-Cycle Current Limiting
- Peak-Current-Mode Control
- Leading-Edge Blanking (LEB)
- Internal Minimum  $t_{OFF}$
- Internal 5 ms Soft-Start
- Over Power Compensation
- GATE Output Maximum Voltage
- Auto-Recovery Over-Current Protection (FB Pin)
- Auto-Recovery Open-Loop Protection (FB Pin)



ON Semiconductor®

[www.onsemi.com](http://www.onsemi.com)

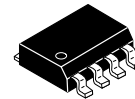

SOIC8  
CASE 751EB

### MARKING DIAGRAM

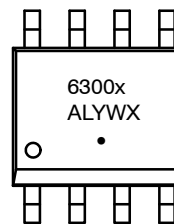

6300x = Specific Device Code  
(x = A or H)  
A = Assembly Location  
L = Wafer Lot Traceability  
YW = Date Code  
X = Manufacture Flow  
• = Pb Free

### PIN ASSIGNMENT

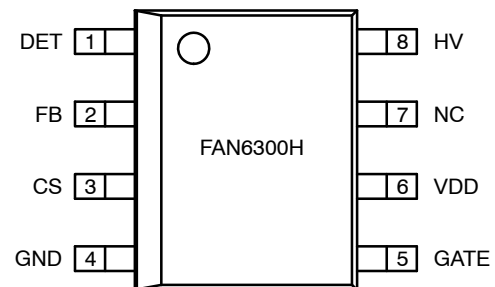

(Top View)

### ORDERING INFORMATION

See detailed ordering and shipping information on page 11 of this data sheet.

- VDD Pin and Output Voltage (DET Pin) OVP Latched
- Low Frequency Operation (below 100 kHz) for FAN6300A
- High Frequency Operation (up to 190 kHz) for FAN6300H

### Applications

- AC/DC NB Adapters
- Open-Frame SMPS

# FAN6300A / FAN6300H

## APPLICATION DIAGRAM

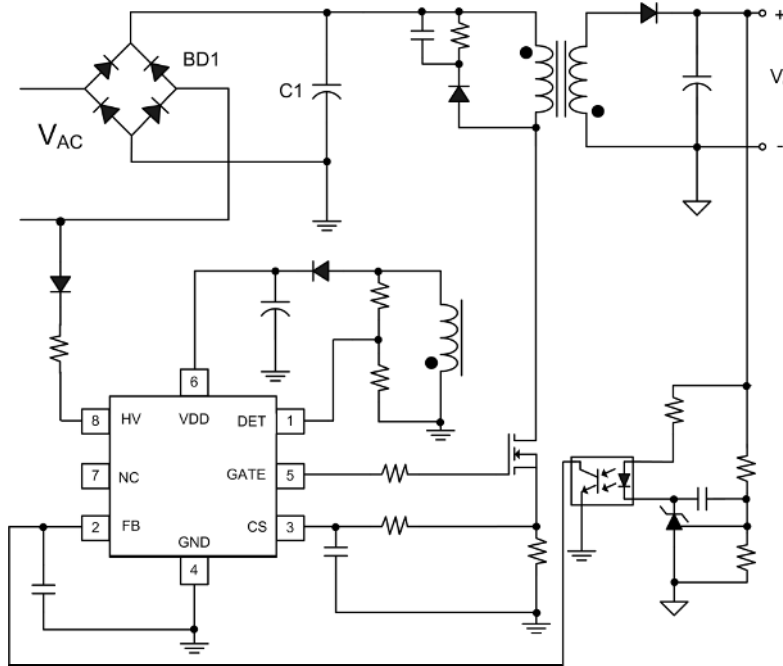

Figure 1. Typical Application

## INTERNAL BLOCK DIAGRAM

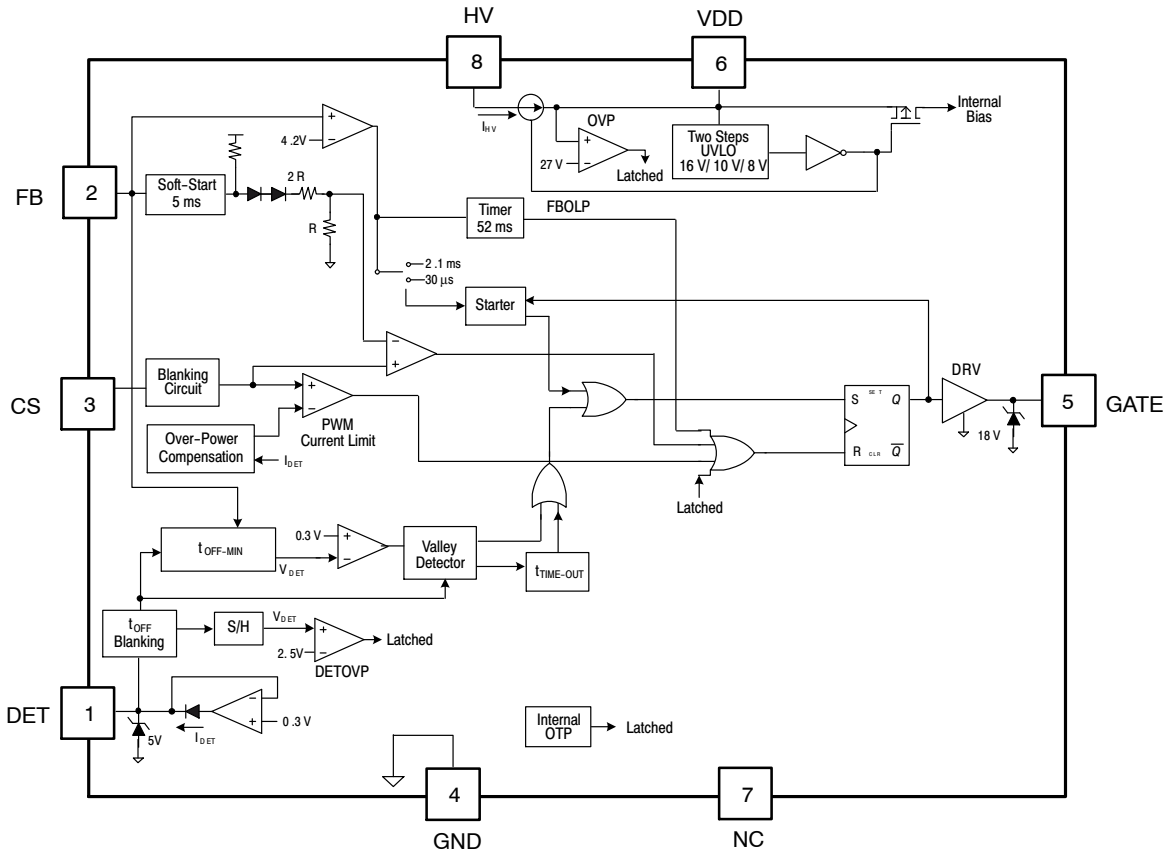

Figure 2. Functional Block Diagram

# FAN6300A / FAN6300H

## PIN CONFIGURATION

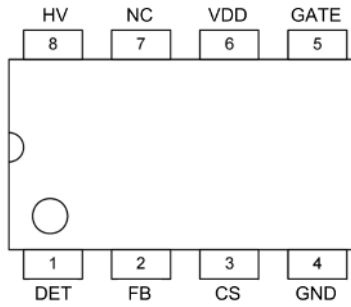

Figure 3. Pin Configuration

## PIN DEFINITIONS

Pin #	Pin Name	Description
1	DET	This pin is connected to an auxiliary winding of the transformer via resistors of the divider for the following purposes: <ul style="list-style-type: none"> <li>– Generates a ZCD signal once the secondary-side switching current falls to zero.</li> <li>– Produces an offset voltage to compensate the threshold voltage of the peak current limit to provide a constant power limit. The offset is generated in accordance with the input voltage when PWM signal is enabled.</li> <li>– Detects the valley voltage of the switching waveform to achieve the valley voltage switching and minimize the switching losses.</li> </ul> A voltage comparator and a 2.5 V reference voltage develop a output OVP protection. The ratio of the divider decides what output voltage to stop gate, as an optical coupler and secondary shunt regulator are used.
2	FB	The feedback pin should be connected to the output of the error amplifier for achieving the voltage control loop. The FB should be connected to the output of the optical coupler if the error-amplifier is equipped at the secondary-side of the power converter. The input impedance of this pin is a 5 k $\Omega$ equivalent resistance. A 1/3 attenuator connected between the FB and the PWM circuit is used for the loop-gain attenuation. FAN6300A/H performs an open-loop protection once the FB voltage is higher than a threshold voltage (around 4.2 V) more than 55 ms.
3	CS	Input to the comparator of the over-current protection. A resistor senses the switching current and the resulting voltage is applied to this pin for the cycle-by-cycle current limit.
4	GND	The power ground and signal ground. A 0.1 $\mu$ F decoupling capacitor placed between VDD and GND is recommended.
5	GATE	Totem-pole output generates the PWM signal to drive the external power MOSFET. The clamped gate output voltage is 18 V.
6	VDD	Power Supply. The threshold voltages for startup and turn-off are 16 V and 10 V, respectively. The startup current is less than 20 $\mu$ A and the operating current is lower than 4.5 mA.
7	NC	No connect
8	HV	High-voltage startup

## FAN6300A / FAN6300H

### ABSOLUTE MAXIMUM RATINGS

Symbol	Parameter	Min.	Max.	Unit
V <sub>DD</sub>	DC Supply Voltage		30	V
V <sub>HV</sub>	Maximum Voltage on HV Pin		500	V
V <sub>H</sub>	Maximum Voltage on GATE Pin	-0.3	25.0	V
V <sub>L</sub>	V <sub>FB</sub> , V <sub>CS</sub> , V <sub>DET</sub> (Maximum Voltage on Low Power Pins)	-0.3	7.0	V
P <sub>D</sub>	Power Dissipation		400	mW
T <sub>J</sub>	Operating Junction Temperature		150	°C
T <sub>STG</sub>	Storage Temperature Range	-55	150	°C
T <sub>L</sub>	Lead Temperature (Soldering 10 seconds)		270	°C
ESD	Human Body Model, JEDEC:JESD22-A114		3.0	kV
	Charged Device Model, JEDEC:JESD22-C101		1.5	

Stresses exceeding those listed in the Maximum Ratings table may damage the device. If any of these limits are exceeded, device functionality should not be assumed, damage may occur and reliability may be affected.

1. Stresses beyond those listed under Absolute Maximum Ratings may cause permanent damage to the device.
2. All voltage values, except differential voltages, are given with respect to GND pin.

### RECOMMENDED OPERATING CONDITIONS

Symbol	Parameter	Min	Max	Unit
T <sub>A</sub>	Operating Ambient Temperature	-40	105	°C

Functional operation above the stresses listed in the Recommended Operating Ranges is not implied. Extended exposure to stresses beyond the Recommended Operating Ranges limits may affect device reliability.

# FAN6300A / FAN6300H

## ELECTRICAL CHARACTERISTICS

(Unless otherwise specified,  $V_{DD} = 10 \sim 25$  V,  $T_A = -40 \sim +105^\circ\text{C}$  ( $T_J = T_A$ ))

Symbol	Parameter	Conditions	Min	Typ	Max	Unit
<b>V<sub>DD</sub> SECTION</b>						
V <sub>OP</sub>	Continuously Operating Voltage				25	V
V <sub>DD-ON</sub>	Turn-On Threshold Voltage		15	16	17	V
V <sub>DD-PWM-OFF</sub>	PWM Off Threshold Voltage		9	10	11	V
V <sub>DD-OFF</sub>	Turn-Off Threshold Voltage		7	8	9	V
I <sub>DD-ST</sub>	Startup Current	$V_{DD} = V_{DD-ON} - 0.16$ V, GATE Open		10	20	μA
I <sub>DD-OP</sub>	Operating Current	$V_{DD} = 15$ V, $f_S = 60$ kHz, $C_L = 2$ nF		4.5	5.5	mA
I <sub>DD-GREEN</sub>	Green-Mode Operating Supply Current (Average)	$V_{DD} = 15$ V, $f_S = 2$ kHz, $C_L = 2$ nF			3.5	mA
I <sub>DD-PWM-OFF</sub>	Operating Current at PWM-Off Phase	$V_{DD} = V_{DD-PWM-OFF} - 0.5$ V	70	80	90	μA
V <sub>DD-OVP</sub>	V <sub>DD</sub> Over-Voltage-Protection (Latch-Off)		26	27	28	V
t <sub>VDD-OVP</sub>	V <sub>DD</sub> OVP Debounce Time		100	150	200	μs
I <sub>DD-LATCH</sub>	V <sub>DD</sub> OVP Latch-Up Holding Current	$V_{DD} = 5$ V		42		μA
<b>HV STARTUP CURRENT SOURCE SECTION</b>						
V <sub>HV-MIN</sub>	Minimum Startup Voltage on Pin HV				50	V
I <sub>HV</sub>	Supply Current Drawn from Pin HV	$V_{AC} = 90$ V ( $V_{DC} = 120$ V), $V_{DD} = 0$ V	1.5		4.0	mA
I <sub>HV-LC</sub>	Leakage Current after Startup	$V_{HV} = 500$ V, $V_{DD} = V_{DD-OFF} + 1$ V		1	20	μA
<b>FEEDBACK INPUT SECTION</b>						
A <sub>V</sub>	Internal Voltage to Current Sense Attenuation	$A_V = \Delta V_{CS} / \Delta V_{FB}$ , $0 < V_{CS} < 0.9$	1/2.75	1/3.00	1/3.25	V/V
Z <sub>FB</sub>	Input Impedance		3	5	7	kΩ
I <sub>OZ</sub>	Bias Current	$FB = V_{OZ}$		1.2	2	mA
V <sub>OZ</sub>	Zero Duty-Cycle Input Voltage		0.8	1.0	1.2	V
V <sub>FB-OLP</sub>	Open Loop Protection Threshold Voltage		3.9	4.2	4.5	V
t <sub>D-OLP</sub>	Debounce Time for Open Loop/Overload Protection		46	52	62	ms
t <sub>SS</sub>	Internal Soft-Start Time			5		ms
<b>DET PIN OVP AND VALLEY DETECTION SECTION</b>						
V <sub>DET-OVP</sub>	Comparator Reference Voltage		2.45	2.50	2.55	V
A <sub>V</sub>	Open-Loop Gain (Note 3)			60		dB
B <sub>W</sub>	Gain Bandwidth (Note 3)			1		MHz
V <sub>V-HIGH</sub>	Output High Voltage		4.5			V
V <sub>V-LOW</sub>	Output Low Voltage				0.5	V
t <sub>DET-OVP</sub>	Output OVP (Latched) Debounce Time		100	150	200	μs
I <sub>DET-SOURCE</sub>	Maximum Source Current	$V_{DET} = 0$ V			1	mA
V <sub>DET-HIGH</sub>	Upper Clamp Voltage	$I_{DET} = -1$ mA			5	V
V <sub>DET-LOW</sub>	Lower Clamp Voltage	$I_{DET} = 1$ mA	0.1	0.3		V
t <sub>VALLEY-DELAY</sub>	Delay Time from Valley-Signal Detected to Output Turn-On (Note 3)			200		ns
t <sub>OFF-BNK</sub>	Leading-Edge-Blanking Time for DET when PWM MOS Turns Off (Note 3)	FAN6300A		4.0		μs
		FAN6300H		1.5		
t <sub>TIME-OUT</sub>	Time-Out after t <sub>OFF-MIN</sub>	FAN6300A		9		μs
		FAN6300H		5		

# FAN6300A / FAN6300H

## ELECTRICAL CHARACTERISTICS (continued)

(Unless otherwise specified,  $V_{DD} = 10 \sim 25$  V,  $T_A = -40 \sim +105^\circ\text{C}$  ( $T_J = T_A$ )) (continued)

Symbol	Parameter	Conditions	Min	Typ	Max	Unit
--------	-----------	------------	-----	-----	-----	------

### OSCILLATOR SECTION

$t_{ON-MAX}$	Maximum On-Time		38	45	54	$\mu\text{s}$
$t_{OFF-MIN}$	Minimum Off-Time	$V_{FB} \geq V_N$ , FAN6300A		8		$\mu\text{s}$
		$V_{FB} \geq V_N$ , FAN6300H		3		$\mu\text{s}$
		$V_{FB} = V_G$ , FAN6300A		38		$\mu\text{s}$
		$V_{FB} = V_G$ , FAN6300H		13		$\mu\text{s}$
$V_N$	Beginning of Green Mode at FB Voltage Level		1.95	2.10	2.25	V
$V_G$	Beginning of Green Mode at FB Voltage Level		1.0	1.2	1.4	V
$\Delta V_{FBG}$	Green Mode $V_{FB}$ Hysteresis Voltage		0.05	0.10	0.20	V
$t_{STARTER}$	Start Timer (Time-Out Timer)	$V_{FB} < V_G$	1.8	2.1	2.4	ms
		$V_{FB} > V_{FB-OLP}$	25	30	45	$\mu\text{s}$

### OUTPUT SECTION

$V_{OL}$	Output Voltage Low	$V_{DD} = 15$ V, $I_O = 150$ mA			1.5	V
$V_{OH}$	Output Voltage High	$V_{DD} = 12$ V, $I_O = 150$ mA	7.5			V
$t_r$	Rising Time			145	200	ns
$t_f$	Falling Time			55	120	ns
$V_{CLAMP}$	Gate Output Clamping Voltage		16.7	18.0	19.3	V

### CURRENT SENSE SECTION

$t_{PD}$	Delay to Output		20	150	200	ns
$V_{LIMIT}$	Limit Voltage on CS Pin for Over-Power Compensation	$I_{DET} < 74.41 \mu\text{A}$	0.82	0.85	0.88	V
		$I_{DET} = 550 \mu\text{A}$	0.380	0.415	0.450	V
$V_{SLOPE}$	Slope Compensation (Note 3)	$t_{ON} = 45 \mu\text{s}$		0.3		V
		$t_{ON} = 0 \mu\text{s}$		0.1		V
$t_{BNK}$	Leading-Edge Blanking Time (MOS Turns ON)		525	625	725	ns
$V_{CS-H}$	$V_{CS}$ Clamped High Voltage once CS Pin Floating	CS Pin Floating	4.5		5.0	V
$t_{CS-H}$	Delay Time once CS Pin Floating	CS Pin Floating		150		$\mu\text{s}$

### INTERNAL OVER-TEMPERATURE PROTECTION SECTION

$T_{OTP}$	Internal Threshold Temperature for OTP (Note 3)			125		$^\circ\text{C}$
$T_{OTP-HYST}$	Hysteresis Temperature for Internal OTP (Note 3)			5		$^\circ\text{C}$

Product parametric performance is indicated in the Electrical Characteristics for the listed test conditions, unless otherwise noted. Product performance may not be indicated by the Electrical Characteristics if operated under different conditions.

3. Guaranteed by design.

TYPICAL PERFORMANCE CHARACTERISTICS

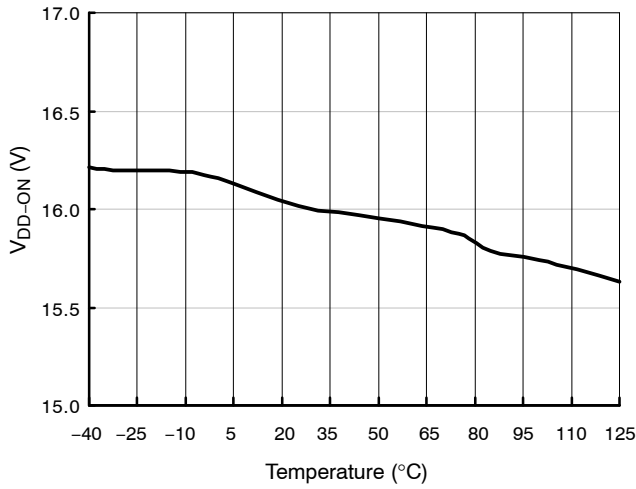

Figure 6. Turn-Off Threshold Voltage

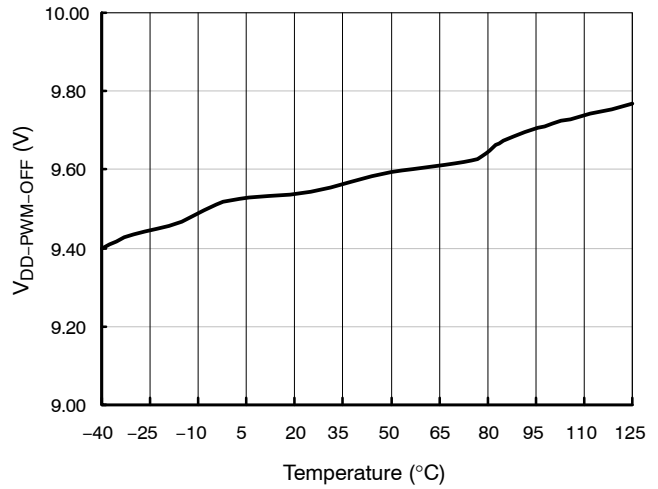

Figure 7. Startup Current

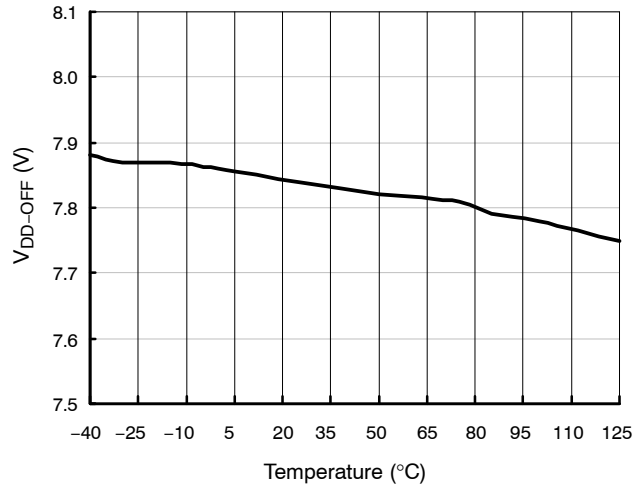

Figure 4. Turn-On Threshold Voltage

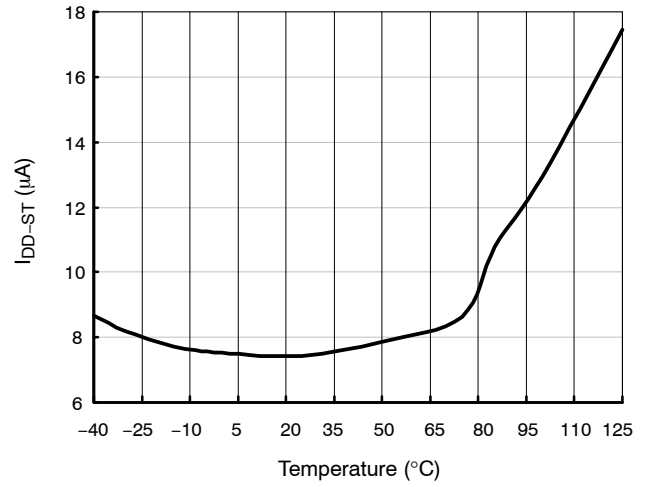

Figure 5. PWM-Off Threshold Voltage

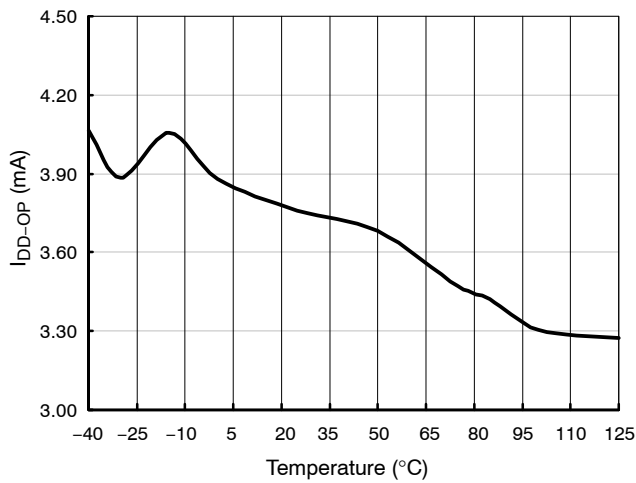

Figure 8. Operating Current

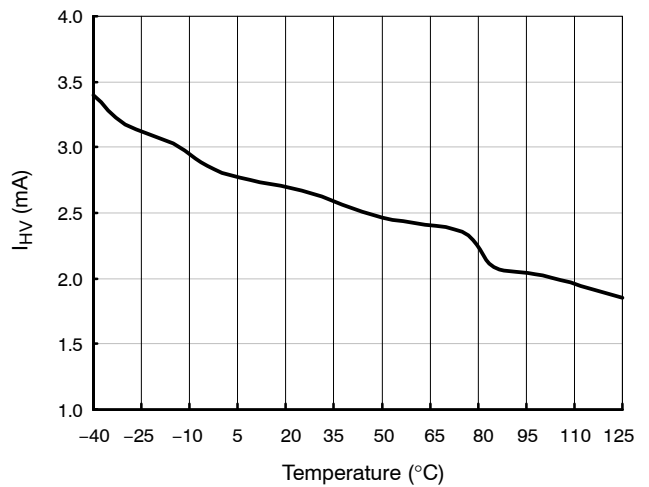

Figure 9. Supply Current Drawn from HV Pin

TYPICAL PERFORMANCE CHARACTERISTICS (continued)

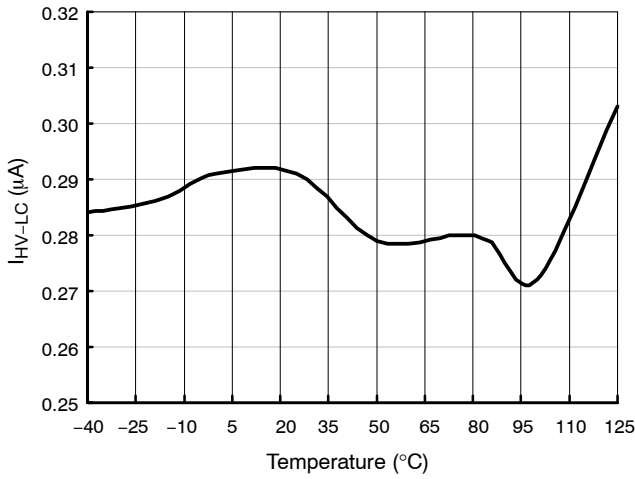

Figure 10. Leakage Current after Startup

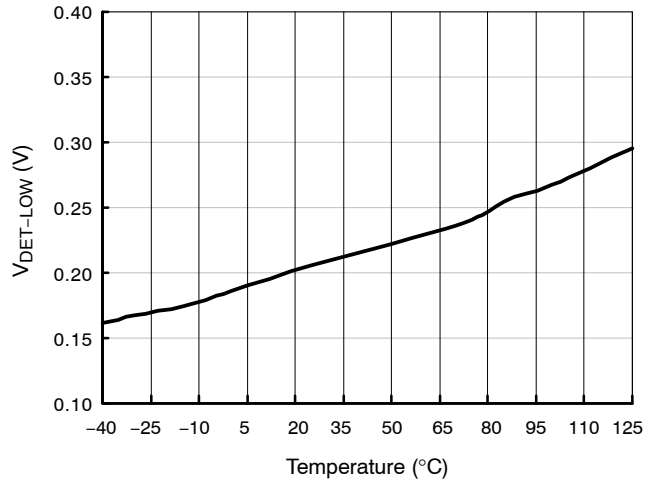

Figure 11. Lower Clamp Voltage

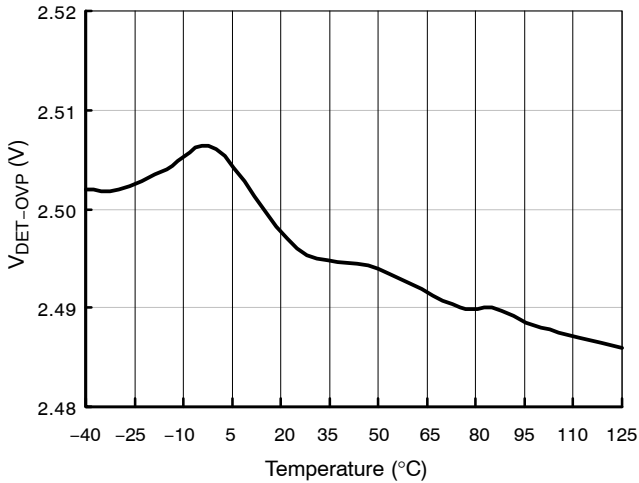

Figure 12. Comparator Reference Voltage

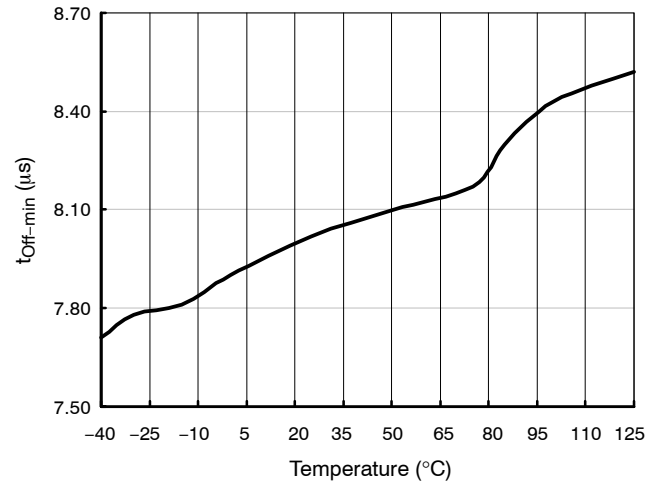

Figure 13. Minimum Off Time ( $V_{FB} > V_N$ )

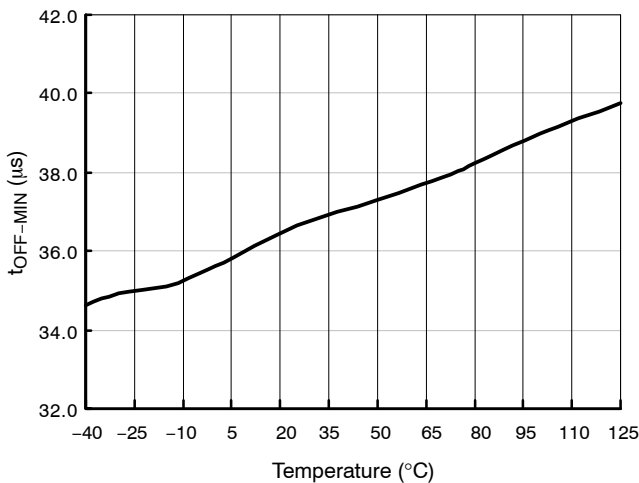

Figure 14. Minimum Off Time ( $V_{FB} = V_G$ )

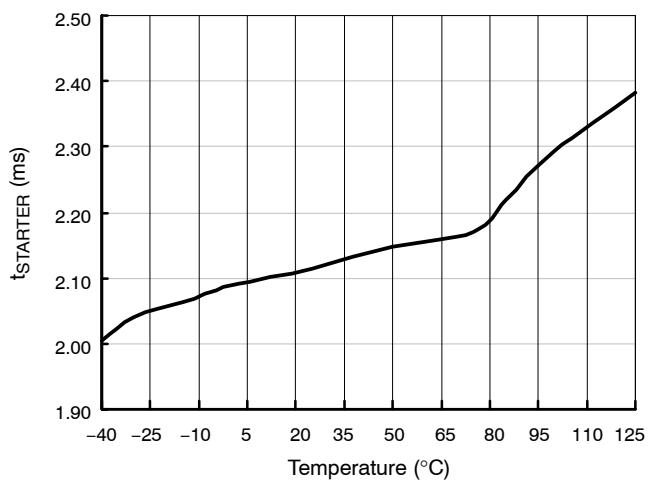

Figure 15. Start Timer ( $V_{FB} < V_G$ )



OPERATION DESCRIPTION

The FAN6300A/H PWM controller integrates designs to enhance the performance of flyback converters. An internal valley voltage detector ensures power system operates at Quasi-Resonant (QR) operation across a wide range of line voltage. The following descriptions highlight some of the features of the FAN6300A/H.

**Startup Current**

For startup, the HV pin is connected to the line input or bulk capacitor through an external diode and resistor,  $R_{HV}$ , which are recommended as 1N4007 and 100 k $\Omega$ . Typical startup current drawn from the HV pin is 1.2 mA and it charges the hold-up capacitor through the diode and resistor. When the  $V_{DD}$  voltage level reaches  $V_{DD-ON}$ , the startup current switches off. At this moment, the  $V_{DD}$  capacitor only supplies the FAN6300A/H to maintain  $V_{DD}$  until the auxiliary winding of the main transformer provides the operating current.

**Valley Detection**

The DET pin is connected to an auxiliary winding of the transformer via resistors of the divider to generate a valley signal once the secondary-side switching current discharges to zero. It detects the valley voltage of the switching waveform to achieve the valley voltage switching. This ensures QR operation, minimizes switching losses, and reduces EMI. Figure 16 shows divider resistors  $R_{DET}$  and  $R_A$ . When  $V_{AUX}$  (in Figure 16) is negative, the DET pin voltage is clamped to  $V_{DET-LOW}$  (0.3 V) by the sourcing current  $I_{DET-SOURCE}$ . The valley of the drain voltage of the main power switch is detected when the sourcing current exceeds 30  $\mu$ A during off time of the GATE signal. Reducing  $R_{DET}$  makes the valley easier to be detected.

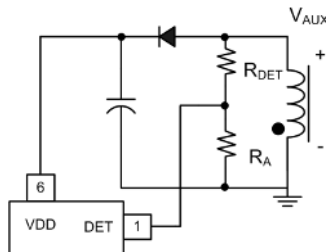

Figure 16. Valley Detect Section

The internal timer (minimum  $t_{OFF}$  time) prevents gate retriggering within 8  $\mu$ s (3  $\mu$ s for H version) after the gate signal going-low transition. The minimum  $t_{OFF}$  limit prevents system frequency being too high. Figure 17 shows a typical drain voltage waveform with first valley switching.

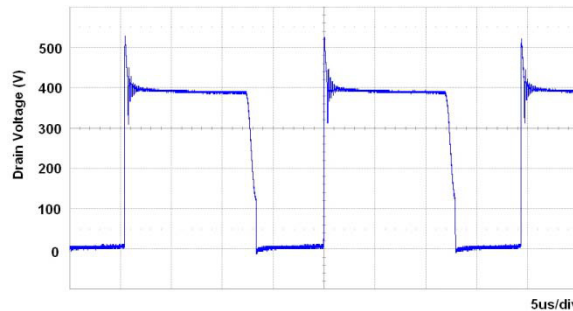

Figure 17. First Valley Switching

**Green-Mode Operation**

The proprietary green-mode function provides off-time modulation to linearly decrease the switching frequency under light-load conditions.  $V_{FB}$ , which is derived from the voltage feedback loop, is taken as the reference. In Figure 18, once  $V_{FB}$  is lower than  $V_N$ ,  $t_{OFF-MIN}$  increases linearly with lower  $V_{FB}$ . The valley voltage detection signal does not start until  $t_{OFF-MIN}$  finishes. Therefore, the valley detect circuit is activated after  $t_{OFF-MIN}$  finishes, which decreases the switching frequency and provides extended valley voltage switching. However, in very light load condition, it might fail to detect the valley voltage due to too low of  $I_{DET-SOURCE}$  after the  $t_{OFF-MIN}$ . Under this condition, an internal  $t_{TIME-OUT}$  signal initiates a new cycle start after a 9  $\mu$ s delay (with 5  $\mu$ s delay for H version). Figure 19 and Figure 20 show the two different conditions.

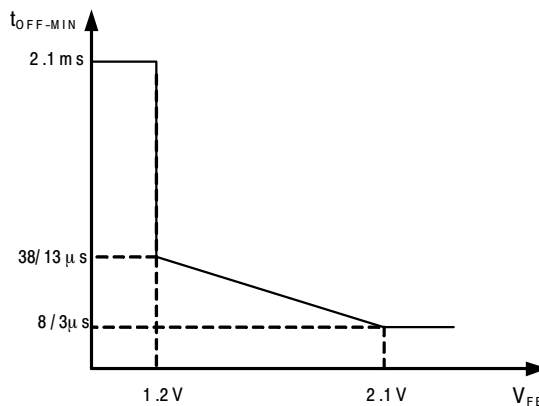
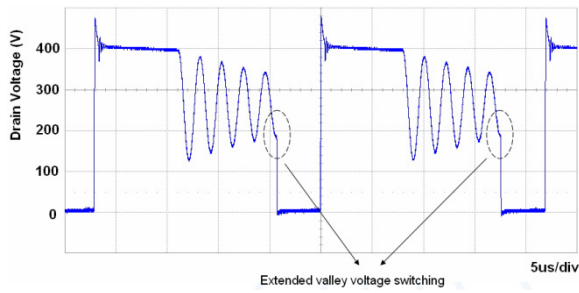
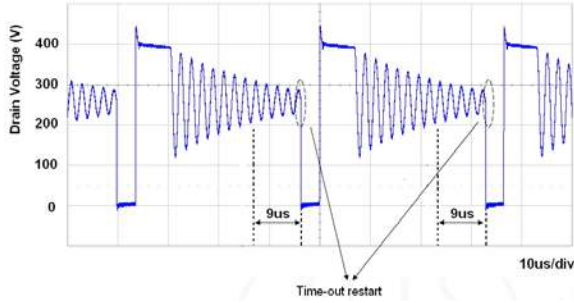

Figure 18.  $V_{FB}$  vs.  $t_{OFF-MIN}$  Curve



**Figure 19. Operation in Extended Valley Voltage Detection Mode**



**Figure 20. Internal  $t_{\text{TIME-OUT}}$  Initiates New Cycle after Failure to Detect Valley Voltage (with 5  $\mu\text{s}$  Delay for FAN6300H version)**

**Peak-Current-Mode PWM**

Peak-current-mode control is utilized to regulate output voltage and provide pulse-by-pulse current limiting. The switch current is detected by a sense resistor into the CS pin. The PWM duty cycle is determined by this current sense signal and  $V_{\text{FB}}$ . When the voltage on CS reaches around  $(V_{\text{FB}}-1.2)/3$ , the PWM signal is turned off immediately.

**Leading-Edge Blanking (LEB)**

Each time the power MOFET switches on, a turn-on spike occurs on the sense resistor. To avoid premature termination of the switching pulse, lead-edge blanking time is built in. During the blanking period, the current limit comparator is disabled; it cannot switch off the gate driver.

**Under-Voltage Lockout (UVLO)**

The turn-on, PWM-off, and turn-off thresholds are fixed internally at 16/10/8 V. During startup, the startup capacitor must be charged to 16 V through the startup resistor to enable the IC. The hold-up capacitor continues to supply  $V_{\text{DD}}$  until energy can be delivered from the auxiliary winding of the main transformer.  $V_{\text{DD}}$  must not drop below 10 V during this startup process. This UVLO hysteresis window ensures that hold-up capacitor is adequate to supply  $V_{\text{DD}}$  during startup.

**Gate Output**

The BiCMOS output stage is a fast totem-pole gate driver. Cross conduction has been avoided to minimize heat dissipation, increase efficiency, and enhance reliability. The output driver is clamped by an internal 18 V Zener diode to protect power MOSFET transistors against undesired over-voltage gate signals.

**Over-Power Compensation**

When CS pin signal hits a  $V_{\text{LIMIT}}$  threshold, GATE signal is terminated to limit the input power. To compensate the variation of over-power limit over wide AC input range, the current limit  $V_{\text{LIMIT}}$  is adjusted according to  $I_{\text{DET-SROUCE}}$  during on time of the GATE signal. During the GATE-on time, the amplitude of  $V_{\text{AUX}}$  is proportional to  $V_{\text{IN}}$ .  $I_{\text{DET-SROUCE}}$  is dominated by  $V_{\text{AUX}}/R_{\text{DET}}$  at this duration.  $V_{\text{LIMIT}}$  decreases linearly when  $I_{\text{DET-SROUCE}}$  is higher than 74.41  $\mu\text{A}$ . This results in a lower current limit at high-line input. Adjusting  $R_{\text{DET}}$  affects the variation of  $V_{\text{LIMIT}}$  across the input voltage range.

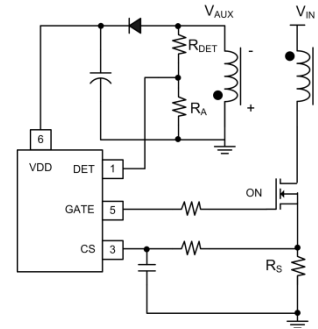

**Figure 21. H/L Line Constant Power Limit Compensated by DET Pin**

**$V_{\text{DD}}$  Over-Voltage Protection**

$V_{\text{DD}}$  over-voltage protection prevents damage due to abnormal conditions. Once the  $V_{\text{DD}}$  voltage is over the  $V_{\text{DD}}$  over-voltage protection voltage ( $V_{\text{DD-OVP}}$ ) and lasts for  $t_{\text{VDD-OVP}}$ , the PWM pulse is disabled and the controller latches off.

**Output Over-Voltage Protection**

The output over-voltage protection works by the sampling voltage, as shown in Figure 22, after switch-off sequence. A 4  $\mu\text{s}$  (1.5  $\mu\text{s}$  for H version) blanking time ignores the leakage inductance ringing. A voltage comparator and a 2.5 V reference voltage develop an output OVP protection. The ratio of the divider determines the sampled voltage, as an optical coupler and secondary shunt

## FAN6300A / FAN6300H

regulator are used. If the DET pin OVP is triggered, the power system enters latch-mode until AC power is removed.

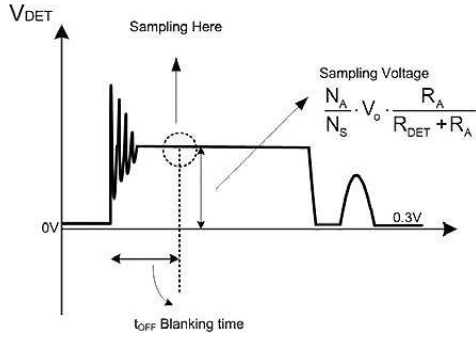

**Figure 22. Voltage Sampled after 4  $\mu$ s (1.5  $\mu$ s for FAN6300H version) Blanking Time after Switch-Off Sequence**

### Short-Circuit and Open-Loop Protection

The FB voltage increases every time the output of the power supply is shorted or overloaded. If the FB voltage remains higher than a built-in threshold for longer than  $t_{D-OLB}$  PWM output is turned off. As PWM output is turned off, the supply voltage  $V_{DD}$  begins decreasing.

When  $V_{DD}$  goes below 8 V, the controller is totally shut down.  $V_{DD}$  is charged up to the turn-on threshold voltage of 16 V through the startup resistor. This protection feature continues as long as the overloading condition persists. This prevents the power supply from overheating due to overloading.

### ORDERING INFORMATION

Device	Operating Temperature Range	Package	Shipping <sup>†</sup>
FAN6300AMY	-40°C to +105°C	8-Lead, Small Outline Package (SOIC) (Pb-Free)	2500 / Tape & Reel
FAN6300HMY			

<sup>†</sup>For information on tape and reel specifications, including part orientation and tape sizes, please refer to our Tape and Reel Packaging Specifications Brochure, BRD8011/D.

**MECHANICAL CASE OUTLINE**  
**PACKAGE DIMENSIONS**

ON Semiconductor®



**SOIC8**  
**CASE 751EB**  
**ISSUE A**

DATE 24 AUG 2017

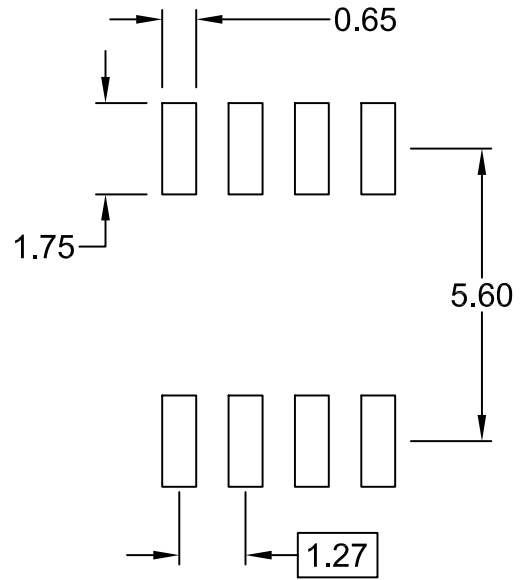
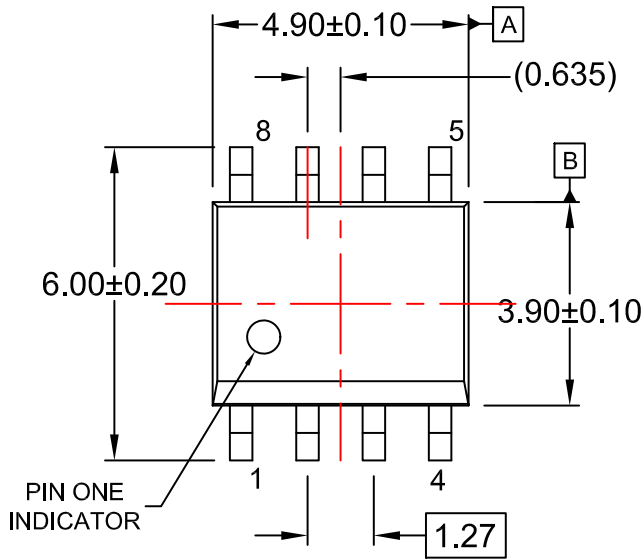

⊕ 0.25 (M) C B A

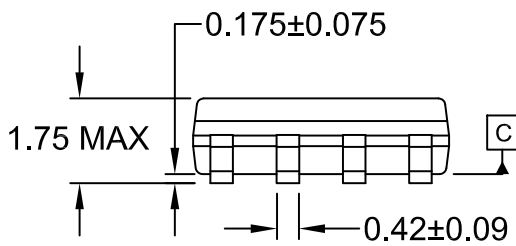

⌒ 0.10

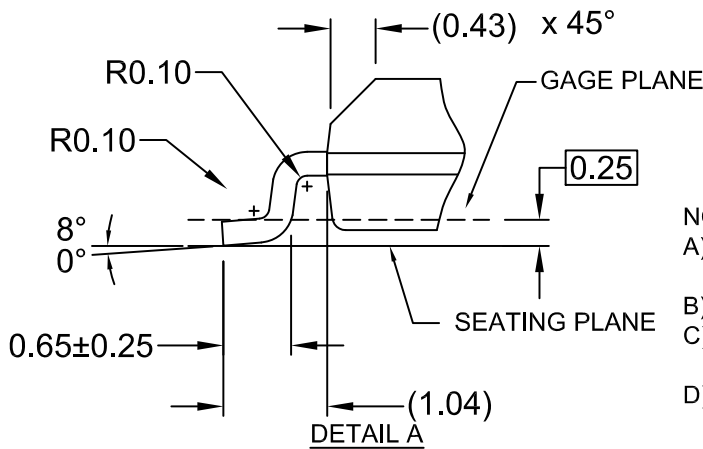
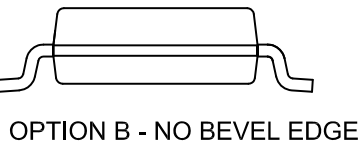
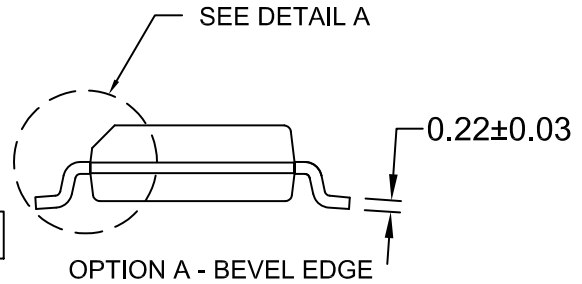

**DETAIL A**  
 SCALE: 2:1

**NOTES:**

- A) THIS PACKAGE CONFORMS TO JEDEC MS-012, VARIATION AA.
- B) ALL DIMENSIONS ARE IN MILLIMETERS.
- C) DIMENSIONS DO NOT INCLUDE MOLD FLASH OR BURRS.
- D) LANDPATTERN STANDARD: SOIC127P600X175-8M

<b>DOCUMENT NUMBER:</b>	<b>98AON13735G</b>	Electronic versions are uncontrolled except when accessed directly from the Document Repository. Printed versions are uncontrolled except when stamped "CONTROLLED COPY" in red.
<b>DESCRIPTION:</b>	<b>SOIC8</b>	<b>PAGE 1 OF 1</b>

ON Semiconductor and are trademarks of Semiconductor Components Industries, LLC dba ON Semiconductor or its subsidiaries in the United States and/or other countries. ON Semiconductor reserves the right to make changes without further notice to any products herein. ON Semiconductor makes no warranty, representation or guarantee regarding the suitability of its products for any particular purpose, nor does ON Semiconductor assume any liability arising out of the application or use of any product or circuit, and specifically disclaims any and all liability, including without limitation special, consequential or incidental damages. ON Semiconductor does not convey any license under its patent rights nor the rights of others.

**onsemi**, **Onsemi**, and other names, marks, and brands are registered and/or common law trademarks of Semiconductor Components Industries, LLC dba "**onsemi**" or its affiliates and/or subsidiaries in the United States and/or other countries. **onsemi** owns the rights to a number of patents, trademarks, copyrights, trade secrets, and other intellectual property. A listing of **onsemi**'s product/patent coverage may be accessed at [www.onsemi.com/site/pdf/Patent-Marking.pdf](http://www.onsemi.com/site/pdf/Patent-Marking.pdf). **onsemi** reserves the right to make changes at any time to any products or information herein, without notice. The information herein is provided "as-is" and **onsemi** makes no warranty, representation or guarantee regarding the accuracy of the information, product features, availability, functionality, or suitability of its products for any particular purpose, nor does **onsemi** assume any liability arising out of the application or use of any product or circuit, and specifically disclaims any and all liability, including without limitation special, consequential or incidental damages. Buyer is responsible for its products and applications using **onsemi** products, including compliance with all laws, regulations and safety requirements or standards, regardless of any support or applications information provided by **onsemi**. "Typical" parameters which may be provided in **onsemi** data sheets and/or specifications can and do vary in different applications and actual performance may vary over time. All operating parameters, including "Typicals" must be validated for each customer application by customer's technical experts. **onsemi** does not convey any license under any of its intellectual property rights nor the rights of others. **onsemi** products are not designed, intended, or authorized for use as a critical component in life support systems or any FDA Class 3 medical devices or medical devices with a same or similar classification in a foreign jurisdiction or any devices intended for implantation in the human body. Should Buyer purchase or use **onsemi** products for any such unintended or unauthorized application, Buyer shall indemnify and hold **onsemi** and its officers, employees, subsidiaries, affiliates, and distributors harmless against all claims, costs, damages, and expenses, and reasonable attorney fees arising out of, directly or indirectly, any claim of personal injury or death associated with such unintended or unauthorized use, even if such claim alleges that **onsemi** was negligent regarding the design or manufacture of the part. **onsemi** is an Equal Opportunity/Affirmative Action Employer. This literature is subject to all applicable copyright laws and is not for resale in any manner.

---

## ADDITIONAL INFORMATION

### TECHNICAL PUBLICATIONS:

Technical Library: [www.onsemi.com/design/resources/technical-documentation](http://www.onsemi.com/design/resources/technical-documentation)  
onsemi Website: [www.onsemi.com](http://www.onsemi.com)

### ONLINE SUPPORT: [www.onsemi.com/support](http://www.onsemi.com/support)

For additional information, please contact your local Sales Representative at [www.onsemi.com/support/sales](http://www.onsemi.com/support/sales)