

Evaluation Board User's Guide

ADC12DS080, 12-Bit, 80 Msp/s A/D Converter

ADC14DS080, 14-Bit, 80 Msp/s A/D Converter

ADC12DS105, 12-Bit, 105 Msp/s A/D Converter

ADC14DS105, 14-Bit, 105 Msp/s A/D Converter

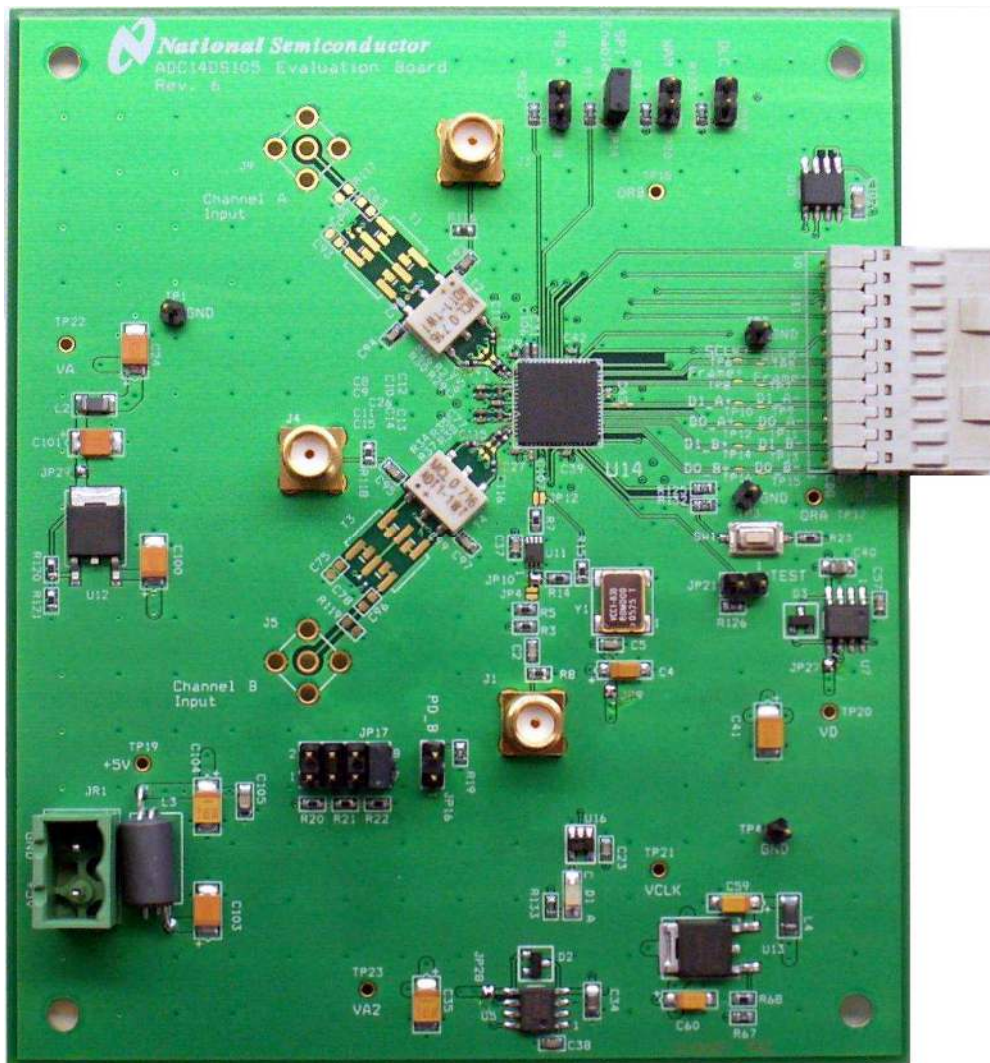

Table of Contents

1.0 Introduction	3
2.0 Board Assembly.....	3
3.0 Quick Start.....	4
4.0 Functional Description.....	4
4.1 Analog Input	4
4.2 ADC reference circuitry.....	5
4.3 ADC clock circuit	5
4.4 Control Panel	5
4.4.1 Operational Mode	5
4.4.2 Data Lane Mode.....	5
4.4.3 Duty Cycle Stabilizer.....	5
4.4.4 Word Alignment	6
4.4.5 Channel A Mode.....	6
4.4.6 Channel B Mode.....	6
4.5 Power Requirements	6
6.0 Hardware Schematic	7
7.0 Evaluation Board Layout.....	9
8.0 Evaluation Board Bill of Materials.....	13
A1.0 Operating in the Computer Mode	15
A2.0 Summary Tables of Test Points, Connectors, and Jumper Settings	15
A2.1 Test Points	15
A2.2 Connectors	15
A2.3 Jumper settings	15
A2.4 Clock Circuit Solder Jumper settings	16

1.0 Introduction

This Evaluation Board may be used to evaluate one of the following A/D Converters : ADC12DS080, ADC14DS080, ADC12DS105, or ADC14DS105. The ADC is one of a family of 12 and 14 bit converters that provides data at rates of up to 105MHz. Further reference in this manual to the ADC14DS105 is meant to also include the other listed parts unless otherwise specified. The ADC14DS105LFEB Evaluation Board is for input frequencies less than 70 MHz.

The evaluation board is designed to be used with the WaveVision5™ Signal Path Data Interface Board (WAVEVSN5). The WAVEVSN5 captures and deserializes the LVDS serialized output data from the ADC. The WAVEVSN5 is connected to a personal

computer through a USB port and running WaveVision5™ software, operating under Microsoft Windows. The software can perform an FFT on the captured data upon command and, in addition to a frequency domain plot, shows dynamic performance in the form of SNR, SINAD, THD SFDR and ENOB. The latest WaveVision hardware and software is available through the National Semiconductor website.

2.0 Board Assembly

The ADC14DS105 Evaluation Board comes pre-assembled. Refer to the Bill of Materials in *Section 8* for a description of components, to *Figure 1* for major component placement and to *Section 6* for the Evaluation Board schematic.

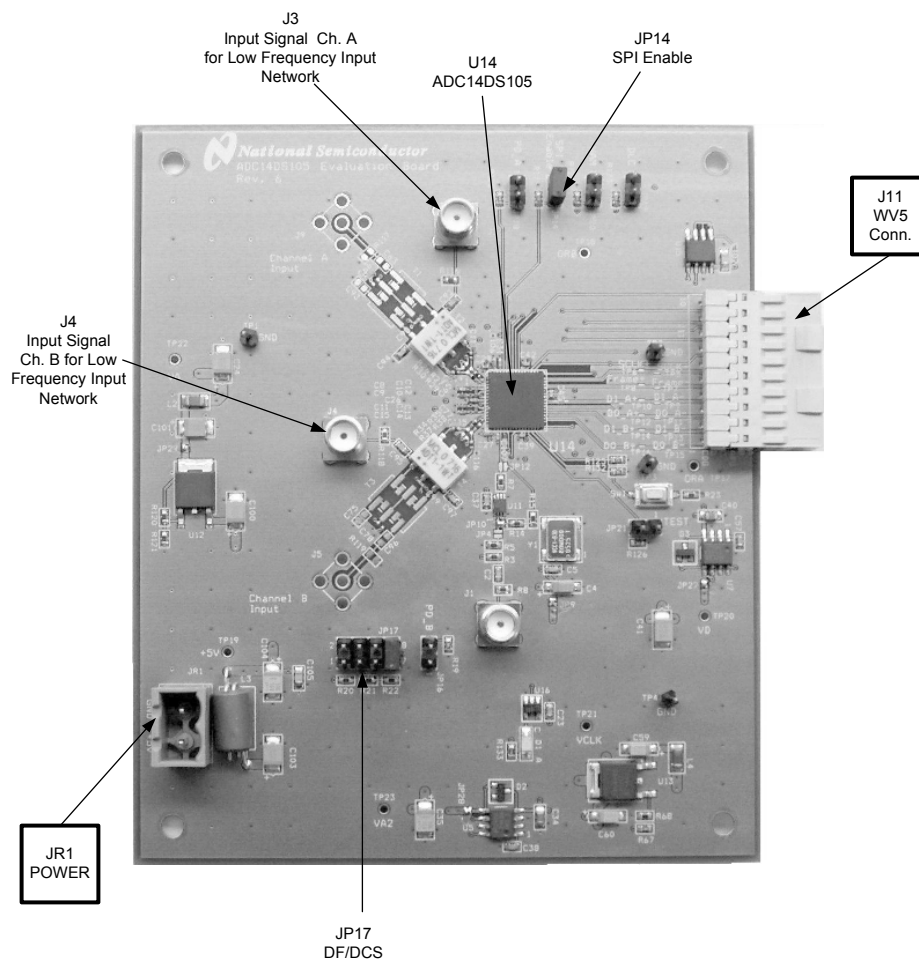

Figure 1. Major Component and Jumper Locations

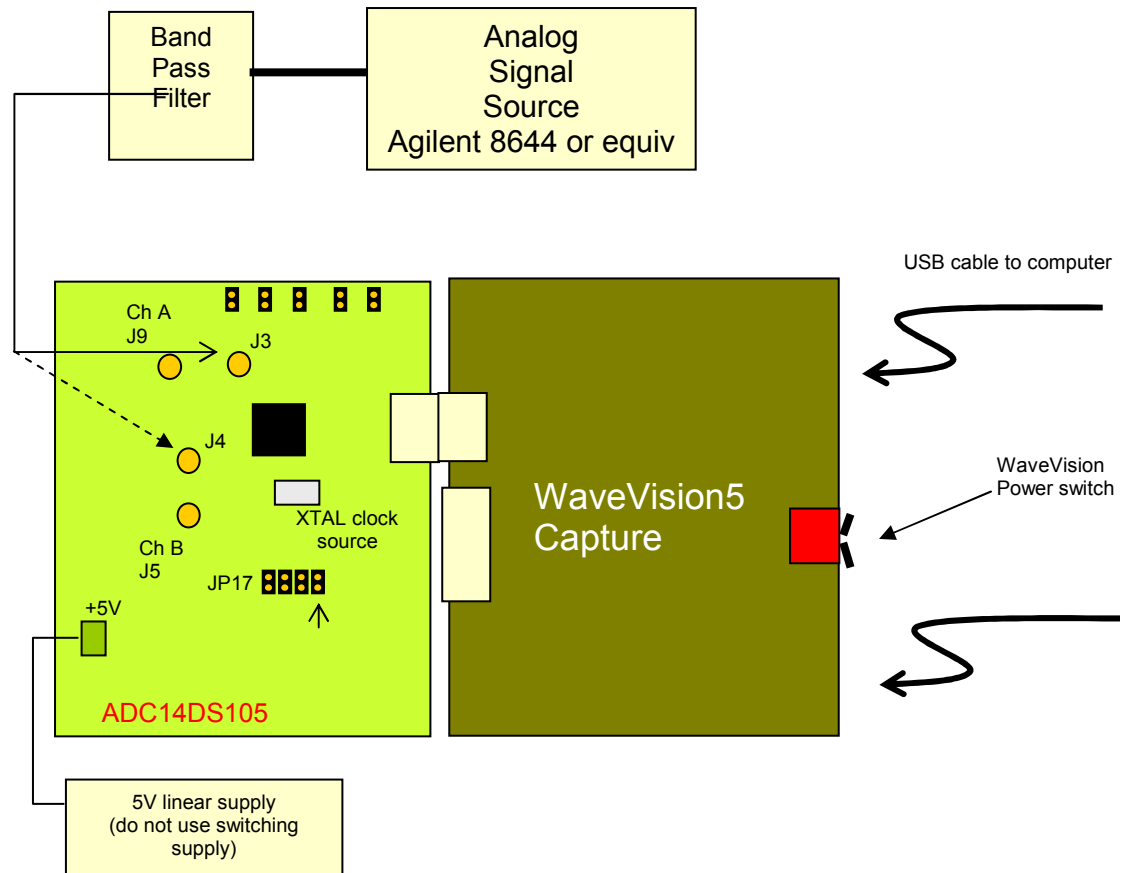

Figure 2. Test Set up

3.0 Quick Start

Refer to *Figure 1* for locations of jumpers, test points and major components. Refer to *Figure 2* for the test set up. The board is configured by default to use a crystal clock source and internal reference. Refer to Section 4.0 and the Appendix for more information on jumper settings.

You must have the WaveVision5™ data capture board and WaveVision5™ software to properly test this board. You can download the latest version from the National Semiconductor website.

1. Apply power to the WAVEVSN5 and connect it to the computer using a USB cable. See the WAVEVSN5 Manual for operation of that board. Connect the evaluation board to the WAVEVSN5. **NOTE: power to the WAVEVSN5 should be applied before power to the ADC14DS105 Evaluation Board to insure that the FPGA on the WAVEVSN5 is not damaged.**
2. Connect a clean +5V power supply to pin 2 of Power Connector JR1. Pin 1 is ground.
3. Connect a signal from a 50-Ohm source to connector J3. Be sure to use a bandpass filter before the Evaluation Board.

4. Adjust the input signal amplitude as needed to ensure that the signal does not over-range by examining a histogram of the output data with the WaveVision™ software.

4.0 Functional Description

The ADC14DS105LFEB schematic is shown in *Section 6*. A list of test points and jumper settings can be found in the Appendix.

4.1 Analog Input

To obtain the best distortion results the analog input network must be optimized for the signal frequency being applied. *Figure 3* shows an example of a circuit that may be used for input frequencies greater than 70MHz. The ADC14DS105LFEB comes configured for input frequencies less than 70MHz. This circuit is shown in *Figure 4*.

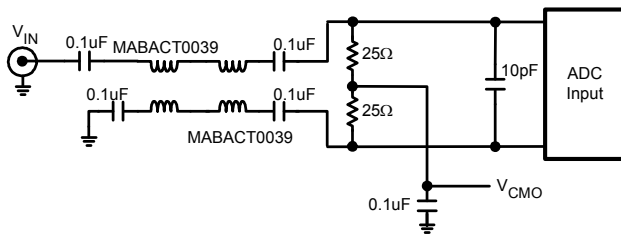

Figure 3. Analog Input Network for $F_{IN} > 70\text{MHz}$

The input network is intended to accept a low-noise sine wave signal of up to 1V peak-to-peak amplitude. To accurately evaluate the dynamic performance of this converter, the input test signal will have to be passed through a high-quality bandpass filter.

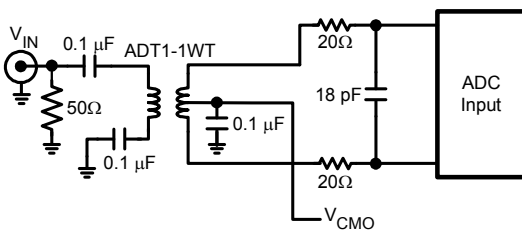

Figure 4. Analog Input Network for $F_{IN} < 70\text{MHz}$

The input signal for Channel A is applied to SMA connector J3. The input signal for Channel B is applied to SMA connector J4.

4.2 ADC reference circuitry

The ADC14DS105 can use an internal or external 1.2V reference. This Evaluation Board is configured to use the internal reference.

4.3 ADC clock circuit

Solder jumpers are used to select the path of the clock to the ADC. While not as convenient as pin-type jumpers, these introduce less noise into the clock signal.

Care must be taken to provide a high quality low jitter clock source. The board has a Pletronics SM7745 or Vectron VCC1 type device crystal clock. The power supply to the crystal has been increased beyond its typical specified 3.3V to about 3.9V. The crystal manufacturers have indicated that this will not damage the part. This increased voltage results in sharper edges and lower jitter. This is more important as the input frequency increases. The clock is then buffered by U11 (NS7WV125) and applied to the ADC's clock input pin.

The user can configure the board for an external clock at connector J1. For this option short the pins of solder jumper JP4 and open the pins of JP9 and JP10. Refer to the schematic for more detail.

4.4 Control Panel

The ADC14DS105LFEB is designed to be used with the WaveVision5™ Signal Path Data Interface Board (WAVEVSN5). This requires that the SPI is enabled by placing a shorting jumper across JP14. With the SPI

enabled, the direct control pins (OF/DCS, WAM, TEST, PD_A, PD_B) have no effect. These functions can be set by changing the fields in the Registers Panel in the WaveVision 5 software. The Registers Panel is shown in Figure 5.

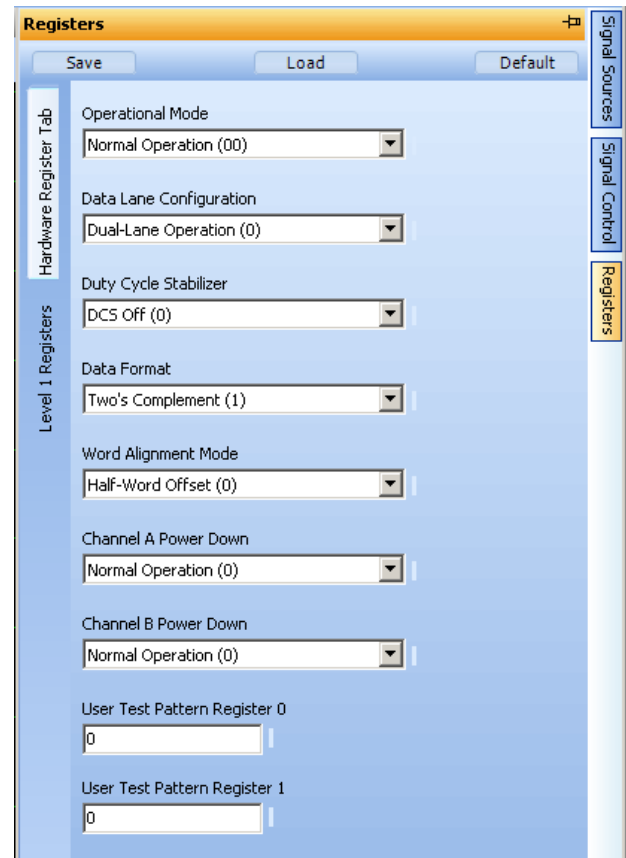

4.4.1 Operational Mode

Normal – The ADC is in normal operation

Fixed Test Mode – A fixed test pattern (10100110001110 msb->lsb) is sourced at the data outputs.

User Test Mode – The test pattern shown in the 'User Test Value' field is sourced at the data outputs.

4.4.2 Data Lane Mode

Dual Lane – The output data is for each channel is sourced on two LVDS pairs. This mode is required when the sample rate is greater than 65MHz when using the WAVEVSN5 to capture data.

Single Lane Mode - The output data is for each channel is sourced on one LVDS pairs.

4.4.3 Duty Cycle Stabilizer

On or Off – Select if Duty cycle stabilization is applied to the input clock.

4.4.4 Word Alignment

Half Word Offset or Word Aligned – Select if the output words should be aligned or offset when the part is used in Dual Lane Mode.

4.4.5 Channel A Mode

Select Normal Operation or Power Down

4.4.6 Channel B Mode

Select Normal Operation or Power Down

4.5 Power Requirements

A 5V power supply capable of 0.5A should be connected to JR1. A linear supply is preferred since it will generate less noise than a switching power supply.

6.0 Hardware Schematic

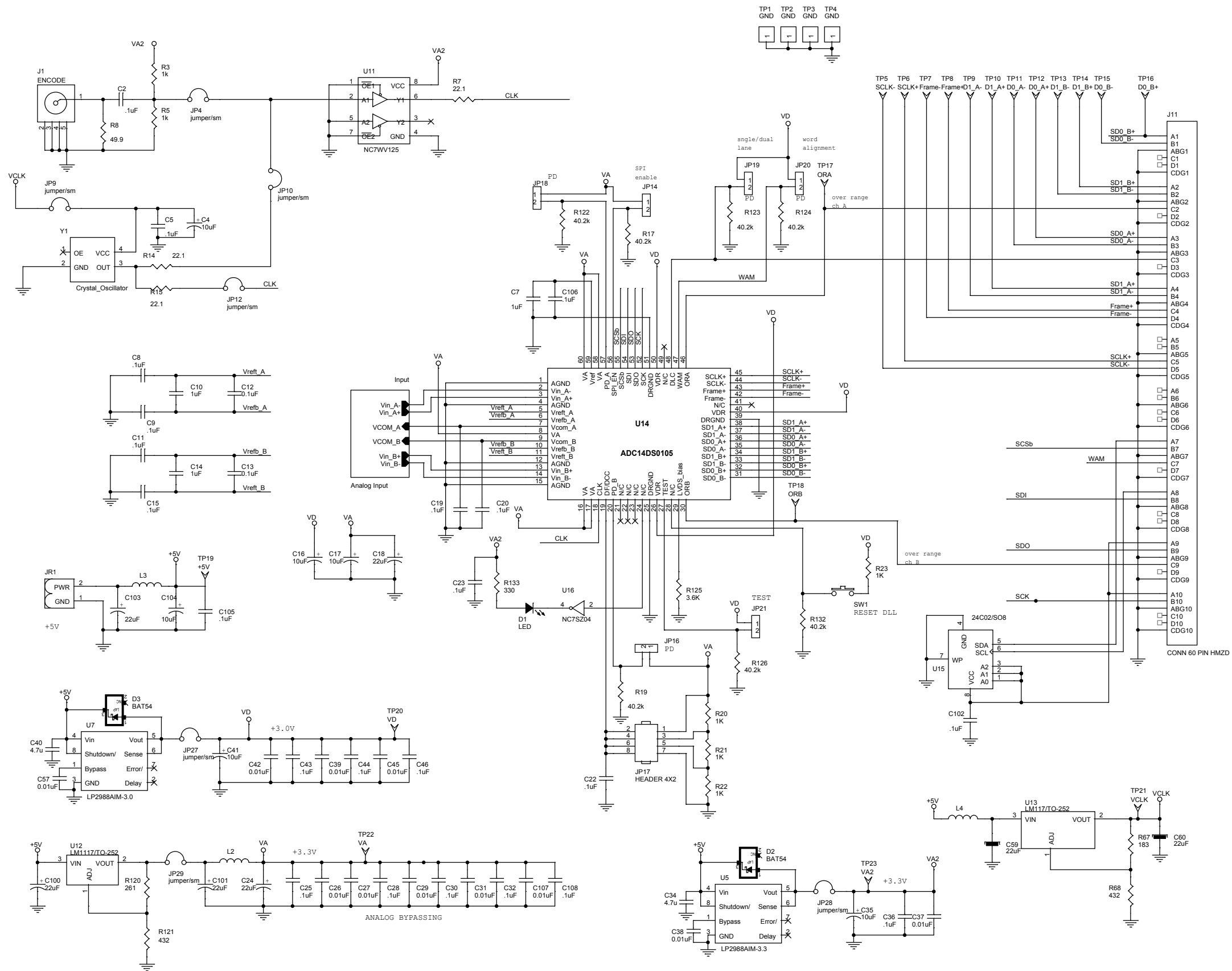

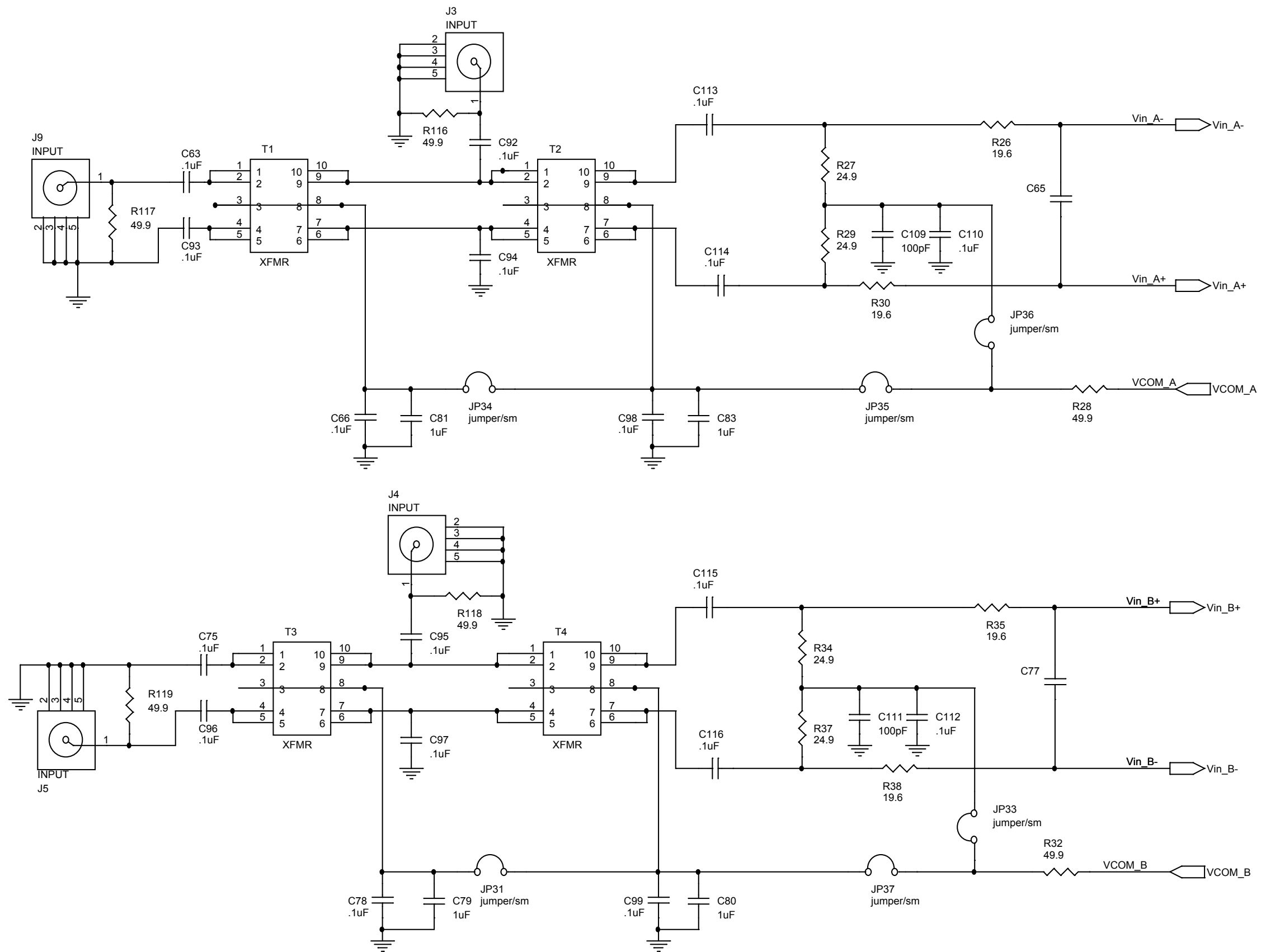

7.0 Evaluation Board Layout

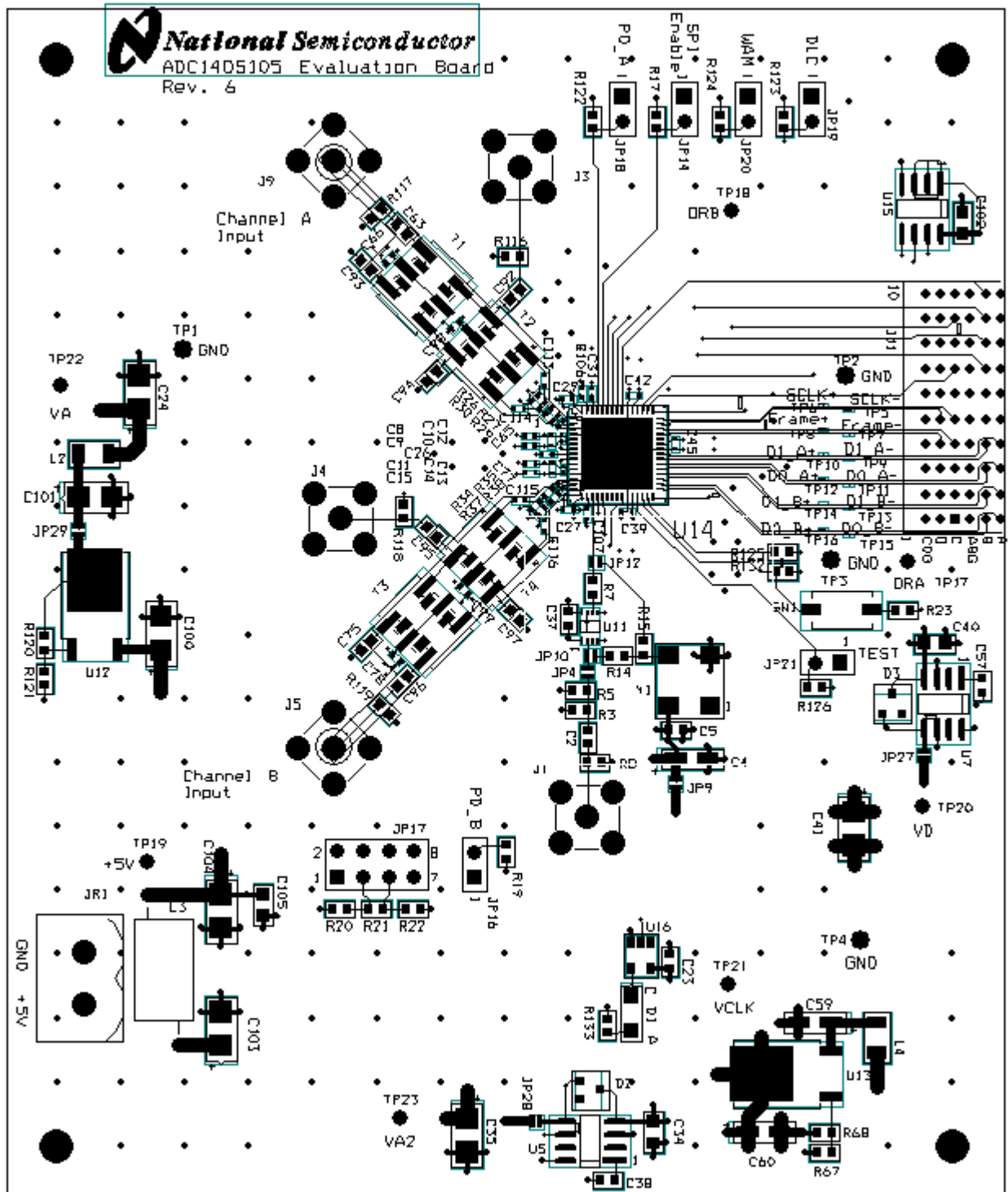

Layer 1 : Component Side

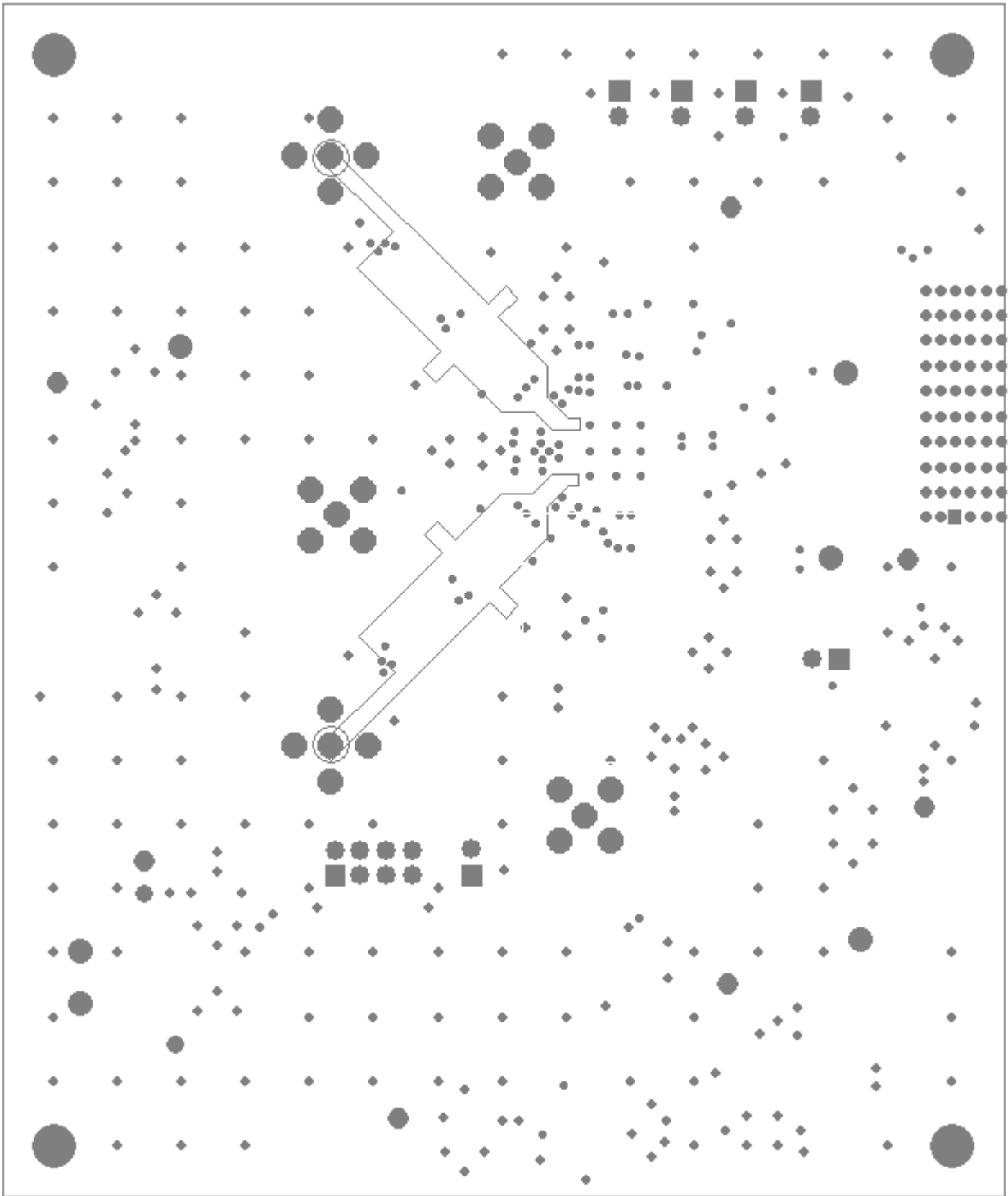

Layer 2 : Ground

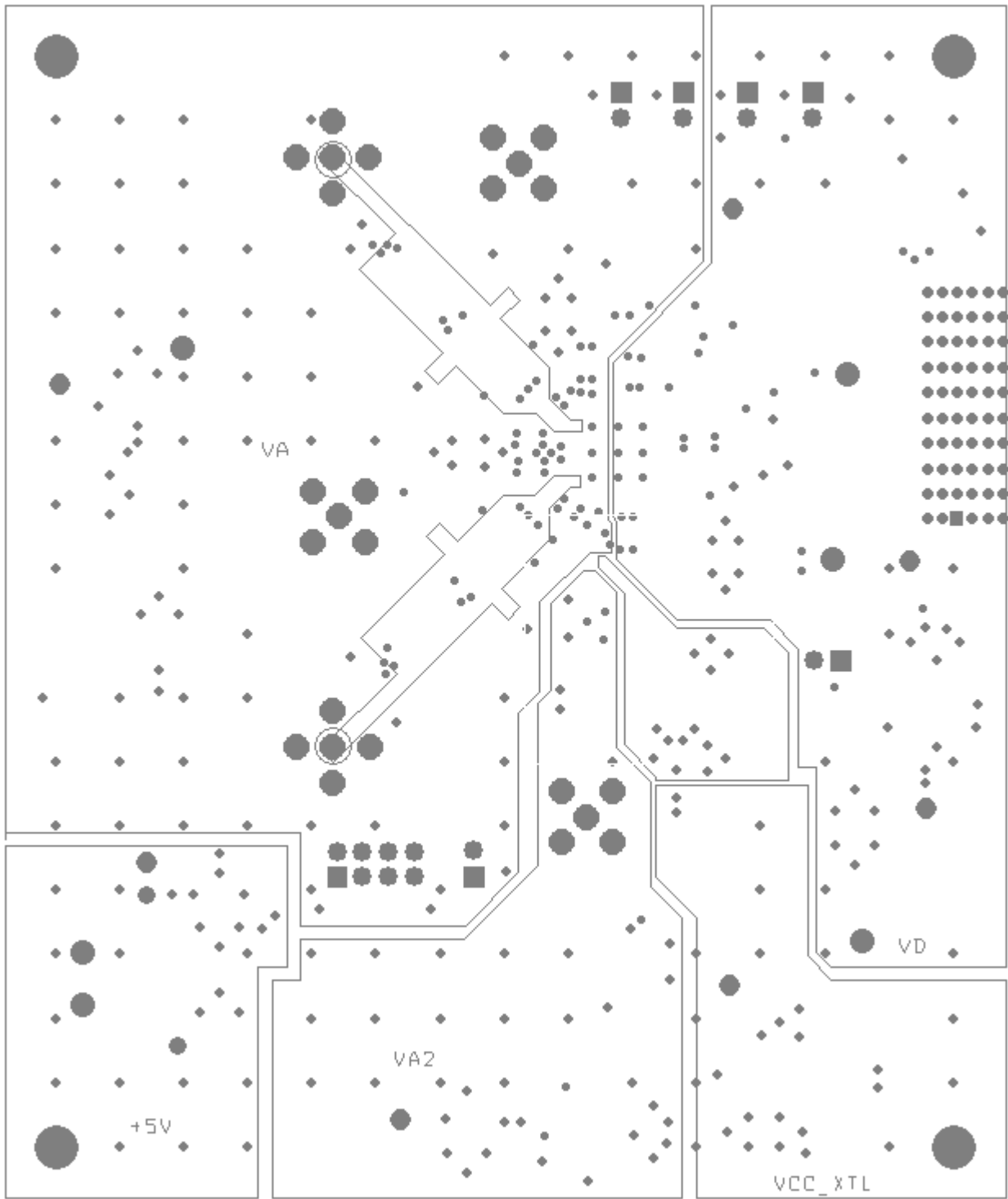

Layer 3 : Power

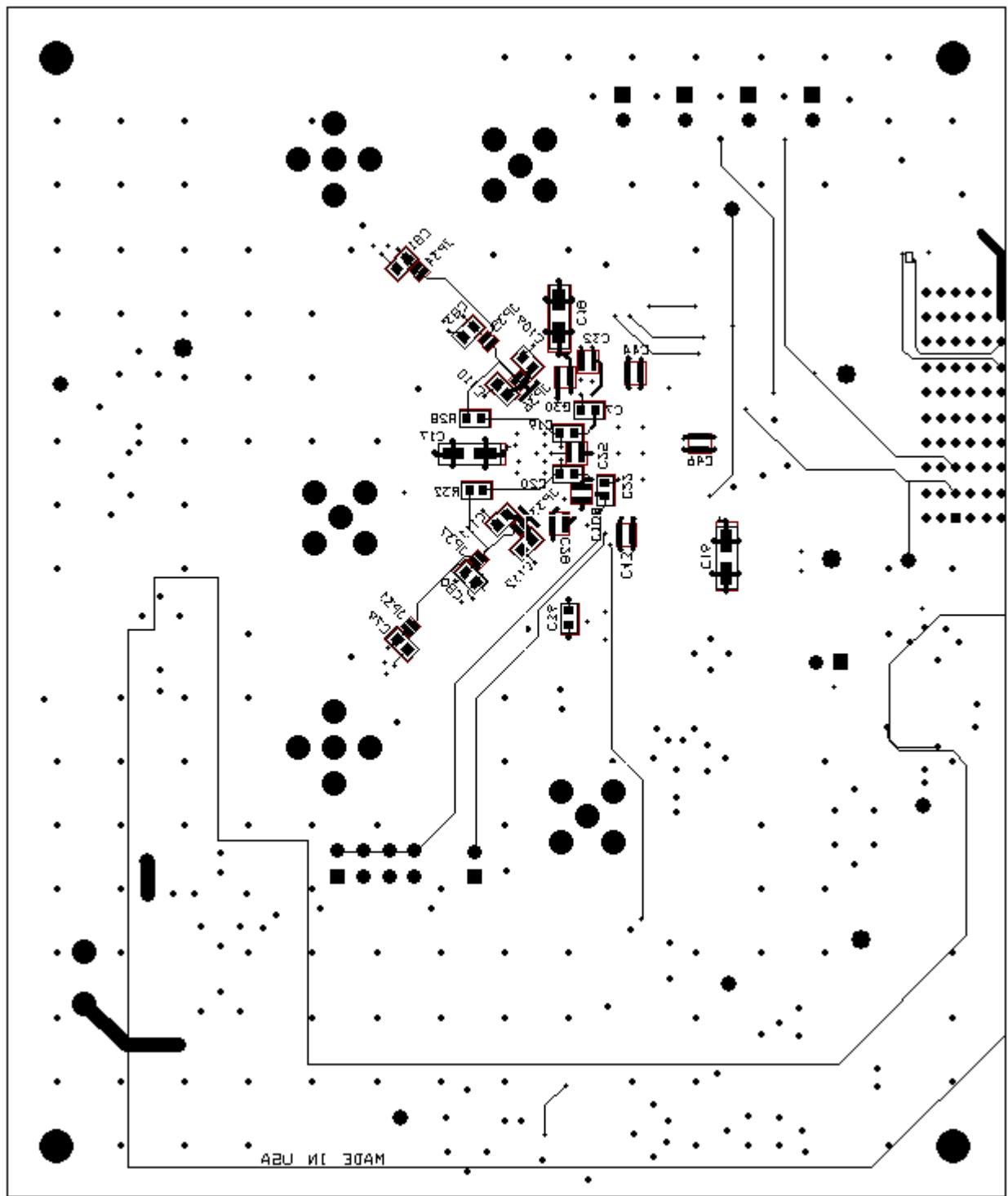

Layer 4 : Circuit Side

8.0 Evaluation Board Bill of Materials

Qty	Reference	Part	PCB Footprint	Part Number	Vendor
13	C2,C5,C19,C20,C22,C23,C36,C92,C94,C95,C97,C110,C112	.1uF	sm/c_0603	PCC1762CT	Digi-Key
3	C4,C16,C17	10uF	sm/ct_3216_12	399-3683-1	Digi-Key
3	C7,C80,C83	1uF	sm/c_0603	PCC2224CT	Digi-Key
7	C8,C9,C11,C15,C98,C99,C106	.1uF	sm/c_0402_no_ss	PCC2146CT	Digi-Key
2	C10,C14	1uF	sm/c_0402_no_ss	PCC13493CT	Digi-Key
2	C12,C13	0.1uF	sm/c_0201_no_ss	PCC2336CT	
1	C18	22uF	sm/ct_3216_12	495-2207-1	Digi-Key
4	C24,C100,C101,C103	22uF	sm/ct_3528_12	478-3476-1	Digi-Key
8	C25,C28,C30,C32,C43,C44,C46,C108	.1uF	sm/c_0508_wide_no_ss	PCC2188CT	Digi-Key
8	C26,C27,C29,C31,C39,C42,C45,C107	0.01uF	sm/c_0402_no_ss	PCC2270CT	Digi-Key
2	C34,C40	4.7u	sm/c_0805	PCC1842CT	Digi-Key
3	C35,C41,C104	10uF	sm/ct_3528_12	495-2238-1	Digi-Key
3	C37,C38,C57	0.01uF	sm/c_0603	PCC1784CT	Digi-Key
2	C59,C60	22uF	SM/CT_3216_12	478-1754-1	Digi-Key
2	C65,C77	18pF	sm/c_0201_no_ss	PCC2116CT	Digi-Key
2	C102,C105	.1uF	sm/c_0805	PCC1828CT	Digi-Key
2	C109,C111	100pF	sm/c_0603	PCC101ACVCT	Digi-Key
1	D1	LED	sm/led_21	516-1440-1-ND	Digi-Key
2	D2,D3	BAT54	SM/SOT23	BAT54-FDICT-ND	Digi-Key
6	JP14,JP16,JP18,JP19,JP20,JP21	Header2	blkcon.100/vh/tm1sqsw.100/2	929647-09-2	
1	JP17	HEADER 4X2	blkcon.100/vh/tm2oe/w.200/8	929665-09-4	
1	JR1	VA / VD Power	MSTBVA2.5/2-G-5.8	277-1150	Digi-key
1	J1	ENCODE	rf/sma/v_clr	ARFX1231	Digi-key
2	J3,J4	INPUT	rf/sma/v_clr	ARFX1231	Digi-key
1	J11	CONN 60 PIN HMZD	hmzdl/2pr/ra/header	6469028-1	National
2	L2,L4	INDUCTOR	sm/l_1206	BLM31PG500SN1L	Digi-Key
1	L3	INDUCTOR	ferrite_choke	M8697	Digi-Key
4	C113,C114,C115,C116	0 ohms	0402 resistor in place of cap	311-0.0JRCT	Digi-Key
6	R3,R5,R20,R21,R22,R23	1K	sm/r_0603	P1.00KHCT	Digi-Key
3	R7,R14,R15	22.1	sm/r_0603	P22.1HCT	Digi-Key
5	R8,R28,R32,R116,R118	49.9	sm/r_0603	P49.9HCT	Digi-Key
7	R17,R19,R122,R123,R124,R126,R132	40.2k	sm/r_0603	311-40.2KHRCT	Digi-Key
4	R26,R30,R35,R38	19.6	sm/r_0402_no_ss	P19.6LCT	Digi-Key
1	R67	183	sm/r_0603	311-182DCT	Digi-Key
2	R68,R121	432	sm/r_0603	P432HCT	Digi-Key
1	R120	261	sm/r_0603	P261HCT	Digi-Key
1	R125	3.6K	sm/r_0603	311-3.60KHRCT	Digi-Key
1	R133	330	sm/r_0603	311-332DCT	Digi-Key

1	SW1	SW PUSHBUTTON	sm/sw	P8087SCT	Digi-Key
2	T2,T4	XFMR	soic10_special	ADT1-1WT+	Minicircuits
1	U5	LP2988AIM-3.3	sog.050/8/wg.244/l.200	LP2988AIM-3.3	Digi-Key
1	U7	LP2988AIM-3.0	sog.050/8/wg.244/l.200	LP2988AIM-3.0/NOPB	National
1	U11	NC7WV125	SOG.50M/8/WG3.10/L2.00	NC7WV125K8X	Mouser
1	U12	LM1117/TO-252	TO252	LM1117DT-ADJ/NOPB	National
1	U13	LM1117/TO-252	TO252	LM1117DT-ADJ/NOPB	National
1	U14	ADC14DS080CISQ or ADC14DS105AISQ		ADC14DS080CISQ or ADC14DS105AISQ	National
1	U15	24C02/SO8	sog.050/8/wg.244/l.200	AT24C02AN-10SU-2.7	Mouser
1	U16	NC7SZ04	SM/SOT23-5	NC7SZ04M5X	Mouser
1	Y1	Crystal_Oscillator	SM/CRYSTAL/5X7	SM7745DV-80.0M or SM7745DV-105.0M	Pletronics

DO NOT POPULATE

J5, J9

R27, R29, R34, R37, R117, R119

C63, C93, C75, C96, C66, C81, C78, C79

T1, T3

TP1,TP2,TP3,TP4	GND	tp/40	929647-09-1
TP5	SCLK-	TP_SM/.00525	N/A
TP6	SCLK+	TP_SM/.00525	N/A
TP7	Frame-	TP_SM/.00525	N/A
TP8	Frame+	TP_SM/.00525	N/A
TP9	D1_A-	TP_SM/.00525	N/A
TP10	D1_A+	TP_SM/.00525	N/A
TP11	D0_A-	TP_SM/.00525	N/A
TP12	D0_A+	TP_SM/.00525	N/A
TP13	D1_B-	TP_SM/.00525	N/A
TP14	D1_B+	TP_SM/.00525	N/A
TP15	D0_B-	TP_SM/.00525	N/A
TP16	D0_B+	TP_SM/.00525	N/A
TP17	ORA	TP_500X/50	5002
TP18	ORB	TP_500X/50	5002
TP19	+5V	TP_500X/50	5002
TP20	VD	TP_500X/50	5002
TP21	VCLK	TP_500X/50	5002
TP22	VA	TP_500X/50	5002
TP23	VA2	TP_500X/50	5002

APPENDIX

A1.0 Operating in the Computer Mode

The ADC14DS105 Evaluation Board is compatible with the WaveVision5™ Data Capture Board and WaveVision5™ software.

When connected to the WaveVision5™ Board, data capture is easily controlled from a personal computer operating in the Windows environment. The data samples that are captured can be observed on the PC video monitor in the time and frequency domains. The FFT analysis of the captured data yields insight into system noise and distortion sources and estimates of ADC dynamic performance such as SINAD, SNR, THD, SFDR and ENOB.

A2.0 Summary Tables of Test Points, Connectors, and Jumper Settings

A2.1 Test Points

Test Points on the ADC14DS105 Evaluation Board

Voltage Signal Name	Measure at	Nominal Voltage (V)
+5V	TP19	5
VA	TP22	3.3
VA2	TP23	3.3
VD	TP20	3.0
VCLK	TP21	3.9

A2.2 Connectors

JR1 Connector - Power Supply Connections

1	GND	Power Supply Ground
2	+5V	+5V Power Supply

A2.3 Jumper settings

Note: Default settings are in **bold**

JP14 : SPI Enable

Connect 1-2	The SPI mode is enabled. This is required when using the ADC14DS105LFEB with the WAVEVSN5. With the SPI enabled, the direct control pins (OF/DCS, WAM, TEST, PD_A, PD_B) have no effect.
1-2 OPEN	The ADC is in normal operation

When the SPI is enabled, the setting of the following jumpers (JP16 – JP21) have no affect. These functions are controlled through the SPI interface.

JP18 : Power Down Channel A

Connect 1-2	Channel A of the ADC is in power down mode
1-2 OPEN	The ADC is in normal operation

JP16 : Power Down Channel B

Connect 1-2	Channel B of the ADC is in power down mode
1-2 OPEN	The ADC is in normal operation

JP17 : Output Data Format and Duty Cycle Stabilizer

Connect 1-2	Output format is 2's complement, DCS is Off
Connect 3-4	Output format is 2's complement, DCS is On
Connect 5-6	Output format is offset binary, DCS is On
Connect 7-8	Output format is offset binary, DCS is Off

JP19 : Single Lane/Dual Lane

Connect 1-2	Single Lane
1-2 OPEN	Dual Lane

JP20 : Word Alignment

Connect 1-2	The output words are aligned.
1-2 OPEN	The output data words are offset by a half-word.

JP21 : TEST

Connect 1-2	The ADC is in fixed test mode, a fixed test pattern (10100110001110 msb->lsb) is sourced at the data outputs.
1-2 OPEN	The ADC is in normal operation

A2.4 Clock Circuit Solder Jumper settings

Solder jumpers are used to select the path of the clock to the ADC. While not as convenient as pin-type jumpers, these introduce less noise into the clock signal.

By default the following jumpers are OPEN: JP9, JP10

By default the following jumpers are shorted: JP4, JP12

BY USING THIS PRODUCT, YOU ARE AGREEING TO BE BOUND BY THE TERMS AND CONDITIONS OF NATIONAL SEMICONDUCTOR'S END USER LICENSE AGREEMENT. DO NOT USE THIS PRODUCT UNTIL YOU HAVE READ AND AGREED TO THE TERMS AND CONDITIONS OF THAT AGREEMENT. IF YOU DO NOT AGREE WITH THEM, CONTACT THE VENDOR WITHIN TEN (10) DAYS OF RECEIPT FOR INSTRUCTIONS ON RETURN OF THE UNUSED PRODUCT FOR A REFUND OF THE PURCHASE PRICE PAID, IF ANY.

The ADC14DS105 Evaluation Boards are intended for product evaluation purposes only and are not intended for resale to end consumers, is not authorized for such use and is not designed for compliance with European EMC Directive 89/336/EEC, or for compliance with any other electromagnetic compatibility requirements.

National Semiconductor Corporation does not assume any responsibility for use of any circuitry or software supplied or described. No circuit patent licenses are implied.

LIFE SUPPORT POLICY

NATIONAL'S PRODUCTS ARE NOT AUTHORIZED FOR USE AS CRITICAL COMPONENTS IN LIFE SUPPORT DEVICES OR SYSTEMS WITHOUT THE EXPRESS WRITTEN APPROVAL OF THE PRESIDENT OF NATIONAL SEMICONDUCTOR CORPORATION. As used herein:

1. Life support devices or systems are devices or systems which, (a) are intended for surgical implant into the body, or (b) support or sustain life, and whose failure to perform, when properly used in accordance with instructions for use provided in the labeling, can be reasonably expected to result in a significant injury to the user.
2. A critical component is any component in a life support device or system whose failure to perform can be reasonably expected to cause the failure of the life support device or system, or to affect its safety or effectiveness.

National Semiconductor Corporation Americas

Tel: 1-800-272-9959
Fax: 1-800-737-7018
Email: support@nsc.com

National Semiconductor Europe

Fax: +49 (0) 1 80-530 85 86
Email: europe.support@nsc.com
Deutsch Tel: +49 (0) 699508 6208
English Tel: +49 (0) 870 24 0 2171
Français Tel: +49 (0) 141 91 8790

National Semiconductor Asia Pacific Customer Response Group

Tel: 65-2544466
Fax: 65-2504466
Email: sea.support@nsc.com

National Semiconductor Japan Ltd.

Tel: 81-3-5639-7560
Fax: 81-3-5639-7507

www.national.com

National does not assume any responsibility for any circuitry described, no circuit patent licenses are implied and National reserves the right at any time without notice to change said circuitry and specifications.

IMPORTANT NOTICE

Texas Instruments Incorporated and its subsidiaries (TI) reserve the right to make corrections, modifications, enhancements, improvements, and other changes to its products and services at any time and to discontinue any product or service without notice. Customers should obtain the latest relevant information before placing orders and should verify that such information is current and complete. All products are sold subject to TI's terms and conditions of sale supplied at the time of order acknowledgment.

TI warrants performance of its hardware products to the specifications applicable at the time of sale in accordance with TI's standard warranty. Testing and other quality control techniques are used to the extent TI deems necessary to support this warranty. Except where mandated by government requirements, testing of all parameters of each product is not necessarily performed.

TI assumes no liability for applications assistance or customer product design. Customers are responsible for their products and applications using TI components. To minimize the risks associated with customer products and applications, customers should provide adequate design and operating safeguards.

TI does not warrant or represent that any license, either express or implied, is granted under any TI patent right, copyright, mask work right, or other TI intellectual property right relating to any combination, machine, or process in which TI products or services are used. Information published by TI regarding third-party products or services does not constitute a license from TI to use such products or services or a warranty or endorsement thereof. Use of such information may require a license from a third party under the patents or other intellectual property of the third party, or a license from TI under the patents or other intellectual property of TI.

Reproduction of TI information in TI data books or data sheets is permissible only if reproduction is without alteration and is accompanied by all associated warranties, conditions, limitations, and notices. Reproduction of this information with alteration is an unfair and deceptive business practice. TI is not responsible or liable for such altered documentation. Information of third parties may be subject to additional restrictions.

Resale of TI products or services with statements different from or beyond the parameters stated by TI for that product or service voids all express and any implied warranties for the associated TI product or service and is an unfair and deceptive business practice. TI is not responsible or liable for any such statements.

TI products are not authorized for use in safety-critical applications (such as life support) where a failure of the TI product would reasonably be expected to cause severe personal injury or death, unless officers of the parties have executed an agreement specifically governing such use. Buyers represent that they have all necessary expertise in the safety and regulatory ramifications of their applications, and acknowledge and agree that they are solely responsible for all legal, regulatory and safety-related requirements concerning their products and any use of TI products in such safety-critical applications, notwithstanding any applications-related information or support that may be provided by TI. Further, Buyers must fully indemnify TI and its representatives against any damages arising out of the use of TI products in such safety-critical applications.

TI products are neither designed nor intended for use in military/aerospace applications or environments unless the TI products are specifically designated by TI as military-grade or "enhanced plastic." Only products designated by TI as military-grade meet military specifications. Buyers acknowledge and agree that any such use of TI products which TI has not designated as military-grade is solely at the Buyer's risk, and that they are solely responsible for compliance with all legal and regulatory requirements in connection with such use.

TI products are neither designed nor intended for use in automotive applications or environments unless the specific TI products are designated by TI as compliant with ISO/TS 16949 requirements. Buyers acknowledge and agree that, if they use any non-designated products in automotive applications, TI will not be responsible for any failure to meet such requirements.

Following are URLs where you can obtain information on other Texas Instruments products and application solutions:

Products

Audio	www.ti.com/audio
Amplifiers	amplifier.ti.com
Data Converters	dataconverter.ti.com
DLP® Products	www.dlp.com
DSP	dsp.ti.com
Clocks and Timers	www.ti.com/clocks
Interface	interface.ti.com
Logic	logic.ti.com
Power Mgmt	power.ti.com
Microcontrollers	microcontroller.ti.com
RFID	www.ti-rfid.com
OMAP Mobile Processors	www.ti.com/omap
Wireless Connectivity	www.ti.com/wirelessconnectivity

Applications

Automotive and Transportation	www.ti.com/automotive
Communications and Telecom	www.ti.com/communications
Computers and Peripherals	www.ti.com/computers
Consumer Electronics	www.ti.com/consumer-apps
Energy and Lighting	www.ti.com/energy
Industrial	www.ti.com/industrial
Medical	www.ti.com/medical
Security	www.ti.com/security
Space, Avionics and Defense	www.ti.com/space-avionics-defense
Video and Imaging	www.ti.com/video

TI E2E Community Home Page

e2e.ti.com

Mailing Address: Texas Instruments, Post Office Box 655303, Dallas, Texas 75265
Copyright © 2012, Texas Instruments Incorporated