



MP2151

5.5V, 1A, Synchronous Step-Down Converter with 25 μ A I_Q and Output Discharge in an Ultra-Small Package

DESCRIPTION

The MP2151 is a monolithic, step-down, switch-mode converter with built-in, internal power MOSFETs. The MP2151 achieves 1A of continuous output current from a 2.5V to 5.5V input voltage with excellent load and line regulation. The output voltage can be regulated as low as 0.6V.

The constant-on-time (COT) control scheme provides fast transient response and eases loop stabilization. Full protection features include cycle-by-cycle current limiting and thermal shutdown.

The MP2151 is ideal for a wide range of applications including high-performance DSPs, wireless power, portable and mobile devices, and other low-power systems.

The MP2151 requires a minimal number of readily available, standard, external components and is available in ultra-small SOT563 or UTQFN (1.2mmx1.6mm) packages.

FEATURES

- Low I_Q: 25 μ A
- 1.1MHz Switching Frequency
- EN for Power Sequencing
- 1% FB Accuracy
- Wide 2.5V to 5.5V Operating Input Range
- Output Adjustable from 0.6V
- Up to 1A Output Current
- 80m Ω and 50m Ω Internal Power MOSFET Switches
- 100% Duty On
- Output Discharge
- Output Over-Voltage Protection (OVP)
- Short-Circuit Protection (SCP) with Hiccup Mode
- Power Good (PG) only for Fixed Output Version
- Available in a SOT563 or UTQFN (1.2mmx1.6mm) Package

APPLICATIONS

- Wireless/Networking Cards
- Portable Instruments
- Battery-Powered Devices
- Low-Voltage I/O System Power
- Multi-Function Printers

All MPS parts are lead-free, halogen-free, and adhere to the RoHS directive. For MPS green status, please visit the MPS website under Quality Assurance. "MPS", the MPS logo, and "Simple, Easy Solutions" are trademarks of Monolithic Power Systems, Inc. or its subsidiaries.

TYPICAL APPLICATION

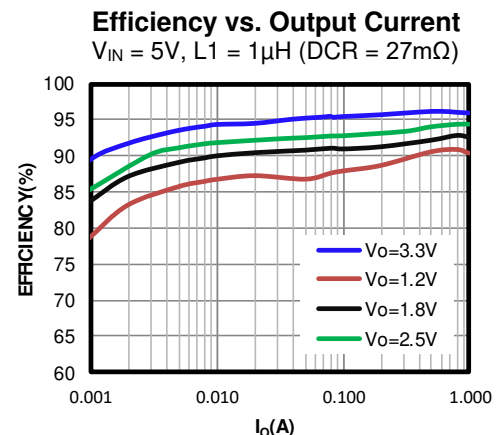
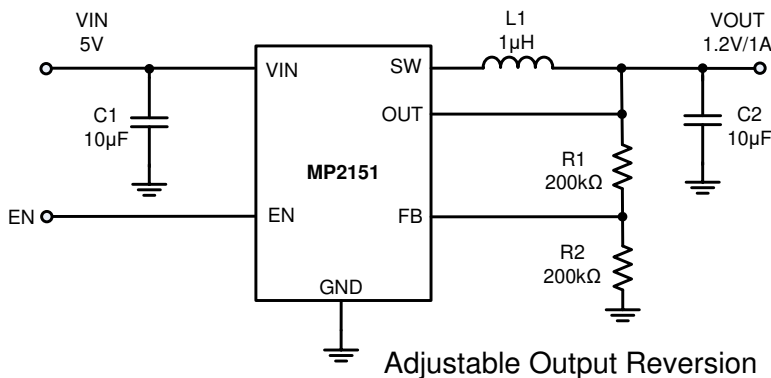

ORDERING INFORMATION

Part Number*	Package	Top Marking	V _{OUT} Range
MP2151GTF	SOT563	See below	Adjustable
MP2151GTF-12		See below	Fixed 1.2V
MP2151GTF-15		See below	Fixed 1.5V
MP2151GTF-18		See below	Fixed 1.8V
MP2151GTF-25		See below	Fixed 2.5V
MP2151GTF-33		See below	Fixed 3.3V

* For Tape & Reel, add suffix –Z (e.g. MP2151GTF–Z).

TOP MARKING (MP2151GTF)

AZDY
LLL

AZD: Product code of MP2151GTF
Y: Year code
LLL: Lot number

TOP MARKING (MP2151GTF-12)

BBDY
LLL

BBD: Product code of MP2151GTF-12
Y: Year code
LLL: Lot number

TOP MARKING (MP2151GTF-15)

BBEY
LLL

BBE: Product code of MP2151GTF-15
Y: Year code
LLL: Lot number

TOP MARKING (MP2151GTF-18)

BBFY
LLL

BBF: product code of MP2151GTF-18
Y: Year code
LLL: Lot number

TOP MARKING (MP2151GTF-25)

BBGY
LLL

BBG: Product code of MP2151GTF-25
Y: Year code
LLL: Lot number

TOP MARKING (MP2151GTF-33)

BBHY
LLL

BBH: Product code of MP2151GTF-33
Y: Year code
LLL: Lot number

PACKAGE REFERENCE

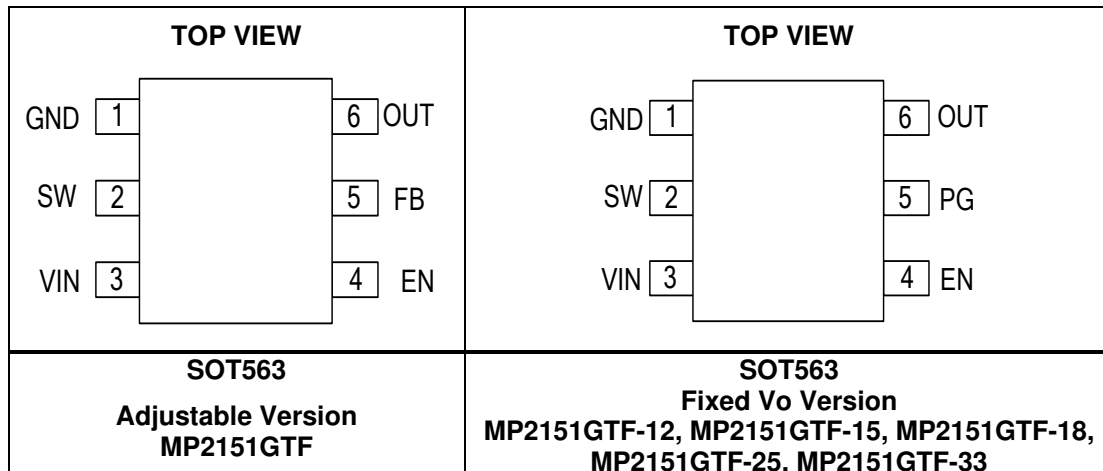

ORDERING INFORMATION

Part Number*	Package	Top Marking	V _{OUT} Range
MP2151GQFU	UTQFN (1.2mmx1.6mm)	See below	Adjustable
MP2151GQFU-12		See below	Fixed 1.2V
MP2151GQFU-15		See below	Fixed 1.5V
MP2151GQFU-18		See below	Fixed 1.8V
MP2151GQFU-25		See below	Fixed 2.5V
MP2151GQFU-33		See below	Fixed 3.3V

* For Tape & Reel, add suffix -Z (e.g. MP2151GQFU-Z).

TOP MARKING (MP2151GQFU)

FX
LL

FX: Product code of MP2151GQFU
LL: Lot number

TOP MARKING (MP2151GQFU-12)

GD
LL

GD: Product code of MP2151GQFU-12
LL: Lot number

TOP MARKING (MP2151GQFU-15)

GE
LL

GE: Product code of MP2151GQFU-15
LL: Lot number

TOP MARKING (MP2151GQFU-18)

GF
LL

GF: Product code of MP2151GQFU-18
LL: Lot number

TOP MARKING (MP2151GQFU-25)

GG
LL

GG: Product code of MP2151GQFU-25
LL: Lot number

TOP MARKING (MP2151GQFU-33)

GH
LL

GH: Product code of MP2151GQFU-33
LL: Lot number

PACKAGE REFERENCE

TOP VIEW	TOP VIEW
UTQFN (1.2mmx1.6mm) MP2151GQFU-Z	UTQFN (1.2mmx1.6mm) MP2151GQFU-12, MP2151GQFU-15 MP2151GQFU-18, MP2151GQFU-25 MP2151GQFU-33

PIN FUNCTIONS

Pin #	Name		Description
	SOT563 and UTQFN		
	Adj version	Fixed version	
1	GND	GND	Power ground.
2	SW	SW	Output switching node. SW is the drain of the internal, high-side, P-channel MOSFET. Connect an inductor to SW to complete the converter.
3	VIN	VIN	Supply voltage. The MP2151 operates from a +2.5V to +5.5V unregulated input range. Decouple the capacitor to prevent large voltage spikes from appearing at the input.
4	EN	EN	On/off control.
5	FB	-	Feedback. An external resistor divider from the output to GND tapped to FB sets the output voltage.
	-	PG	Power good indicator. The output of PG is an open drain with an external pull-up resistor to VIN.
6	OUT	OUT	Output sense. OUT is the voltage power rail and input sense pin for the output voltage. Connect the load to OUT. Use an output capacitor to decrease the output voltage ripple.

ABSOLUTE MAXIMUM RATINGS ⁽¹⁾

Supply voltage (V _{IN})	6.5V
V _{SW}	-0.3V (-5V for <10ns) to 6.5V (10V for <10ns)
All other pins	-0.3V to 6.5V
Junction temperature	150°C
Lead temperature	260°C
Continuous power dissipation (T _A = +25°C)	
SOT563	1.5W ⁽²⁾⁽⁴⁾
UTQFN	2W ⁽²⁾⁽⁵⁾
Storage temperature	-65°C to +150°C

Recommended Operating Conditions ⁽³⁾

Supply voltage (V _{IN})	2.5V to 5.5V
Operating junction temp. (T _J)	-40°C to +125°C

Thermal Resistance

	θ _{JA}	θ _{JC}
SOT563		
EV2151-TF-00A ⁽⁴⁾	80	50
JESD51-7 ⁽⁶⁾	130	60
UTQFN (1.2mmx1.6mm)		
EV2151-QFU-00A ⁽⁵⁾	65	30
JESD51-7 ⁽⁶⁾	173	127

NOTES:

- Exceeding these ratings may damage the device.
- The maximum allowable power dissipation is a function of the maximum junction temperature T_J (MAX), the junction-to-ambient thermal resistance θ_{JA}, and the ambient temperature T_A. The maximum allowable continuous power dissipation at any ambient temperature is calculated by P_D (MAX) = (T_J (MAX) - T_A) / θ_{JA}. Exceeding the maximum allowable power dissipation produces an excessive die temperature, causing the regulator to go into thermal shutdown. Internal thermal shutdown circuitry protects the device from permanent damage.
- The device is not guaranteed to function outside of its operating conditions.
- Measured on EV2151-TF-00A, 2-layer PCB, 63mmx63mm.
- Measured on EV2151-QFU-00A, 2-layer PCB, 63mmx63mm.
- Measured on JESD51-7, 4-layer PCB.

The value of θ_{JA} given in this table is valid for comparison with other packages only and cannot be used for design purposes. These values are calculated in accordance with JESD51-7 and are simulated on a specified JEDEC board. They do not represent the performance obtained in an actual application.

ELECTRICAL CHARACTERISTICS

V_{IN} = 3.6V, T_J = -40°C to +125°C⁽⁶⁾, typical value is tested at T_J = +25°C. The limit over temperature is guaranteed by characterization, unless otherwise noted.

Parameter	Symbol	Condition	Min	Typ	Max	Units
V _{IN} range			2.5		5.5	V
Under-voltage lockout threshold rising				2.3	2.45	V
Under-voltage lockout threshold hysteresis				200		mV
Feedback voltage	V _{FB}	T _J = 25°C	594	600	606	mV
		T _J = -40°C to +125°C	591	600	609	
OUT voltage (MP2151XX-12)	V _O	T _J = 25°C	1188	1200	1212	mV
		T _J = -40°C to +125°C	1182	1200	1218	mV
OUT voltage (MP2151XX-15)	V _O	T _J = 25°C	1485	1500	1515	mV
		T _J = -40°C to +125°C	1478	1500	1522	mV
OUT voltage (MP2151XX-18)	V _O	T _J = 25°C	1782	1800	1818	mV
		T _J = -40°C to +125°C	1873	1800	1827	mV
OUT voltage (MP2151XX-25)	V _O	T _J = 25°C	2475	2500	2525	mV
		T _J = -40°C to +125°C	2463	2500	2537	mV
OUT voltage (MP2151XX-33)	V _O	T _J = 25°C	3267	3300	3333	mV
		T _J = -40°C to +125°C	3251	3300	3349	mV
Feedback current	I _{FB}	V _{FB} = 0.63V		50	100	nA
P-FET switch on resistance	R _{DSON_P}	V _{IN} = 5V		80		m Ω
N-FET switch on resistance	R _{DSON_N}	V _{IN} = 5V		50		m Ω
Switch leakage		V _{EN} = 0V, V _{IN} = 6V, V _{SW} = 0V and 6V, T _J = +25°C		0	1	μ A
P-FET peak current limit			1.8			A
ZCD				50		mA
On time	T _{ON}	V _{IN} = 5V, V _{OUT} = 1.2V	180	220	260	ns
		V _{IN} = 3.6V, V _{OUT} = 1.2V	240	300	360	
Switching frequency	f _s	V _{OUT} = 1.2V		1100		kHz
Minimum off time	T _{MIN-OFF}			100		ns
Minimum on time ⁽⁶⁾	T _{MIN-ON}			60		ns
Soft-start time	T _{SS-ON}	V _{OUT} rise from 10% to 90%		0.5		ms
Maximum duty cycle			100			%
Power good rising threshold UV		Fixed V _O version, V _{OUT} rising edge		90		%
Power good falling threshold UV		Fixed V _O version, V _{OUT} falling edge		85		%
Power good rising threshold OV		Fixed V _O version, V _{OUT} rising edge		115		%
Power good falling threshold OV		Fixed V _O version, V _{OUT} falling edge		105		%

ELECTRICAL CHARACTERISTICS (continued)

V_{IN} = 3.6V, T_J = -40°C to +125°C⁽⁶⁾, typical value is tested at T_J = +25°C. The limit over temperature is guaranteed by characterization, unless otherwise noted.

Parameter	Symbol	Condition	Min	Typ	Max	Units
Power good delay	PG _D	Fixed Vo version, PG rising/falling edge		150		μ s
Power good sink current capability	V _{PG-L}	Fixed Vo version, sink 1mA			0.4	V
Power good logic high voltage	V _{PG-H}	Fixed Vo version, V _{IN} = 5V, V _{FB} = 0.6V	4.9			V
EN turn on delay		EN on to SW active		150		us
EN input logic low voltage					0.4	V
EN input logic high voltage			1.2			V
Output discharge resistor	R _{DIS}	V _{EN} = 0V, V _{OUT} = 1.2V		200		Ω
EN input current		V _{EN} = 2V		1.2		μ A
		V _{EN} = 0V		0		μ A
Supply current (shutdown)		V _{EN} = 0V, T _J = +25°C		0	1	μ A
Supply current (quiescent) (MP2151XX, adjustable)		V _{EN} = 2V, V _{FB} = 0.63V, V _{IN} = 5V, T _J = +25°C		25	30	μ A
Supply current (quiescent) (MP2151XX-XX, fixed Vo)		V _{EN} = 2V, no switching, V _{IN} = 5V, T _J = +25°C		30	35	μ A
Output over-voltage threshold	V _{OVP}		110%	115%	120%	V _{FB}
Vo OVP hysteresis	V _{OVP_HYS}			10%		V _{FB}
OVP delay				12		us
Low-side current		Current flow from SW to GND		1.5		A
Absolute VIN OVP		After Vo OVP enable		6.1		V
Absolute VIN OVP hysteresis				400		mV
Thermal shutdown ⁽⁷⁾				160		°C
Thermal hysteresis ⁽⁷⁾				30		°C

NOTES:

- 7) Guaranteed by over-temperature correlation, not tested in production.
 8) Guaranteed by engineering sample characterization.

TYPICAL CHARACTERISTICS

V_{IN} = 3.6V, V_{OUT} = 1.2V, L = 1 μ H, C_{OUT} = 22 μ F, T_A = +25°C, unless otherwise noted.

Efficiency vs. I_o

V_{IN} = 5V

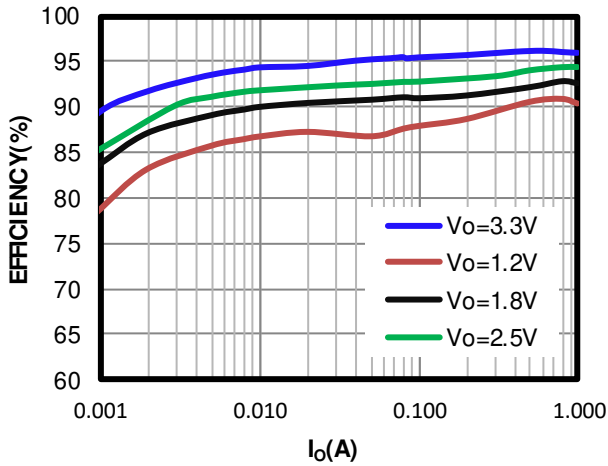

Efficiency vs. I_o

V_{IN} = 3.6V

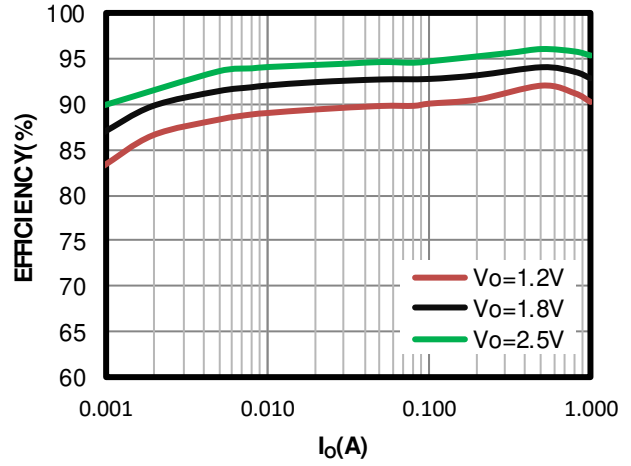

Load Regulation

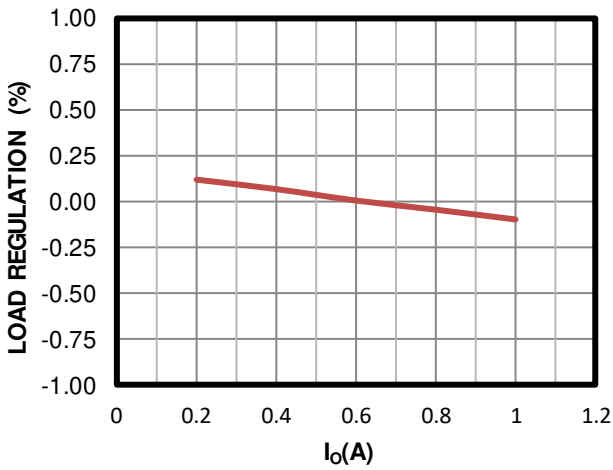

Line Regulation

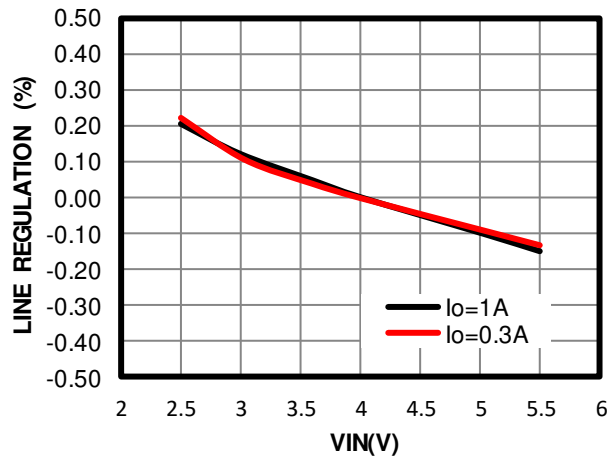

Quiescent Current vs. V_{IN}

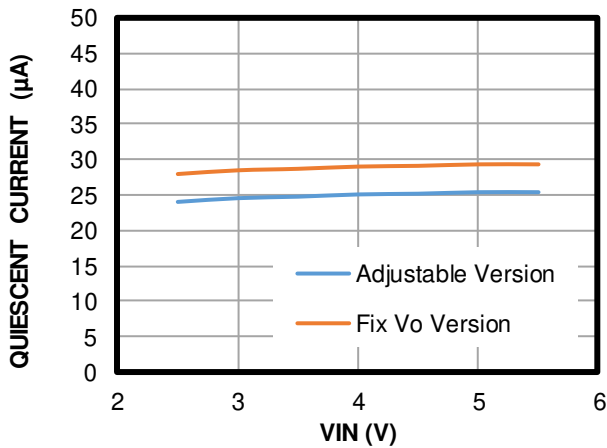

Shutdown Current vs. Input Voltage

V_{EN} = 0V

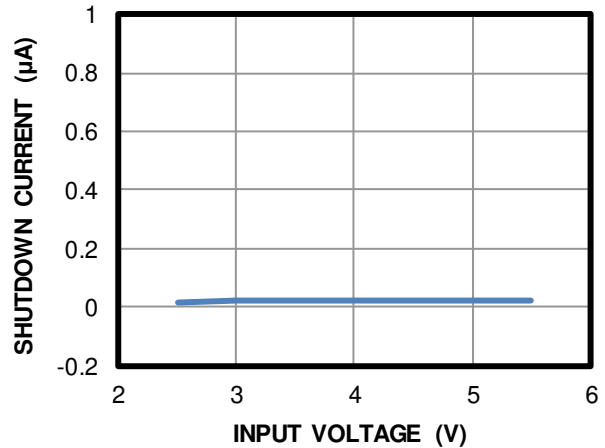

TYPICAL CHARACTERISTICS (continued)

 V_{IN} = 3.6V, V_{OUT} = 1.2V, L = 1µH, C_{OUT} = 22µF, T_A = +25°C, unless otherwise noted.

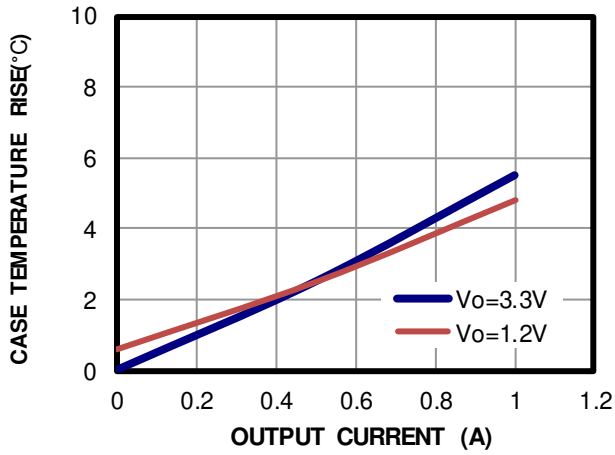
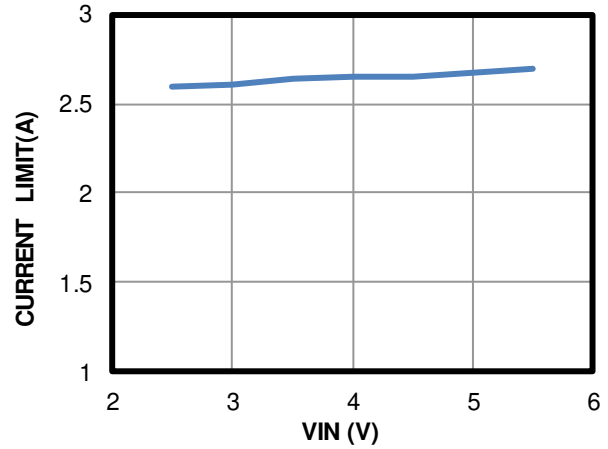
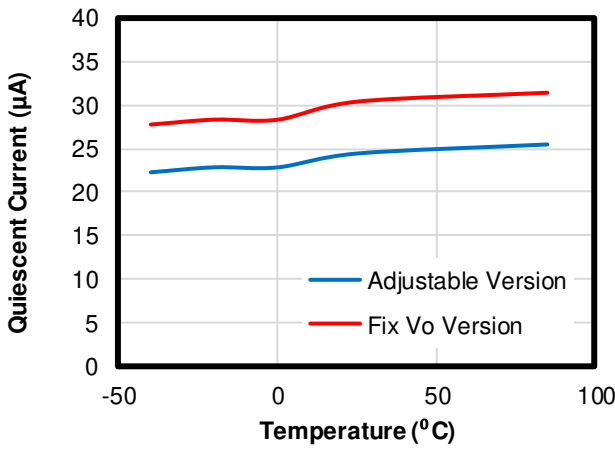
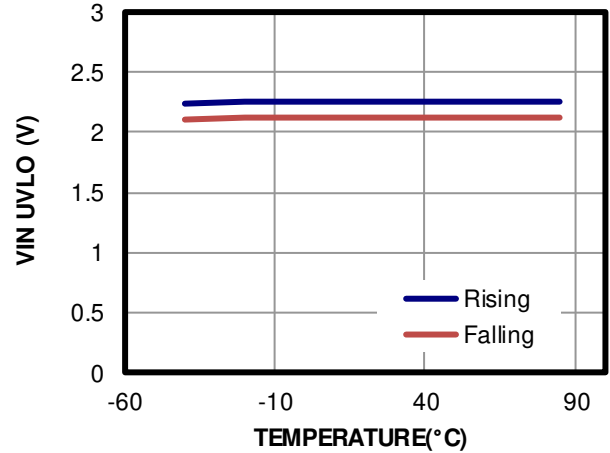
Case Temperature Rising vs. Output Current

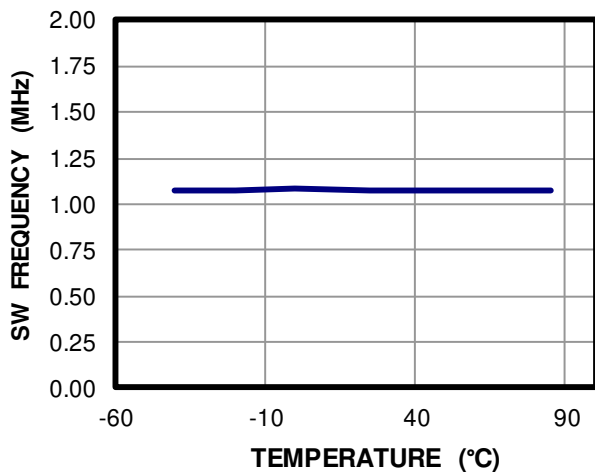
Peak Current Limit vs. V_{IN}

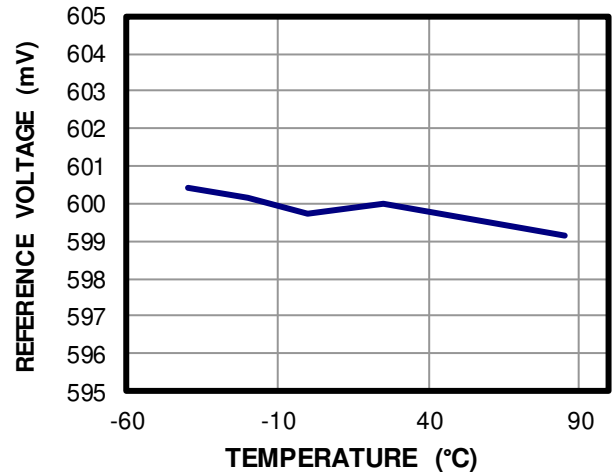
Quiescent Current vs. Temperature

V_{IN} UVLO Rising Threshold vs. Temperature

Switch Frequency vs. Temperature

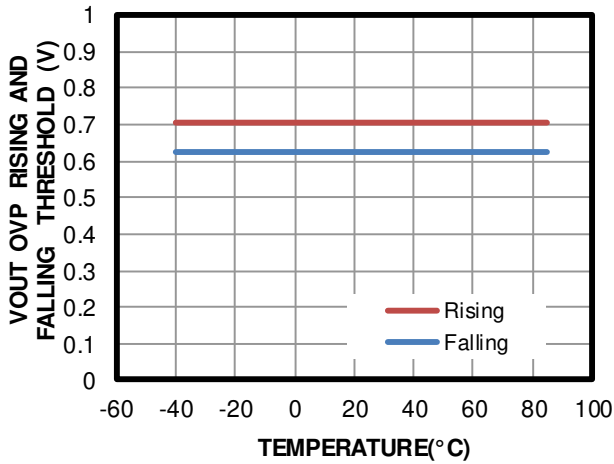
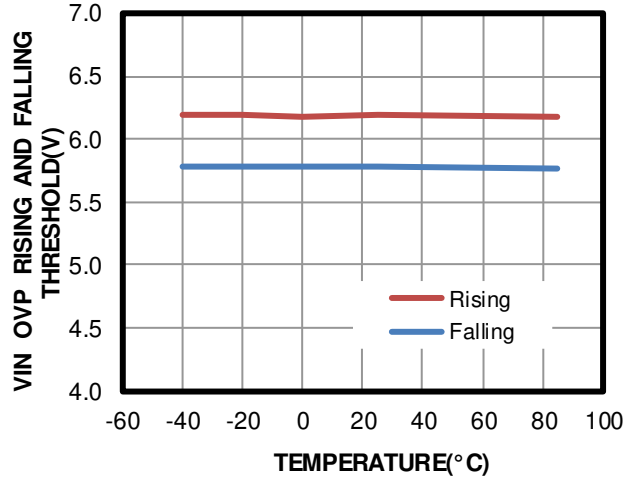
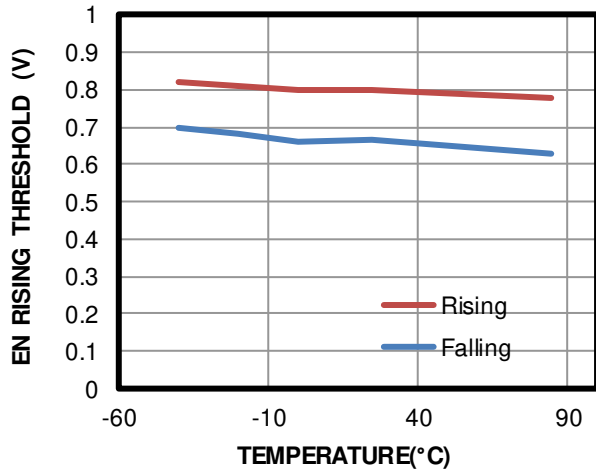
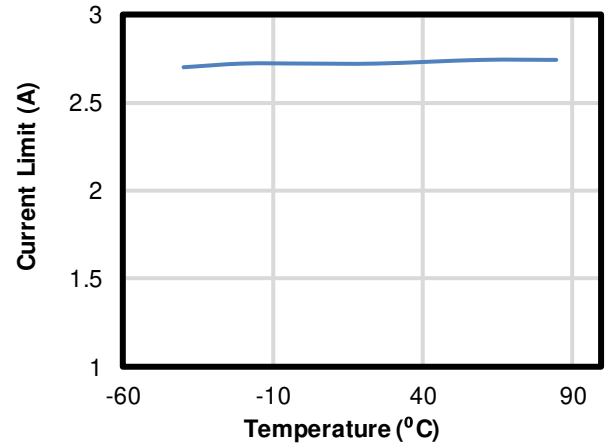
 V_{IN} = 3.6V, V_{OUT} = 1.2V, I_{OUT} = 500mA

Reference Voltage vs. Temperature

 V_{IN} = 3.6V

TYPICAL CHARACTERISTICS (continued)

 V_{IN} = 3.6V, V_{OUT} = 1.2V, L = 1 μ H, C_{OUT} = 22 μ F, T_A = +25 $^{\circ}$ C, unless otherwise noted.

V_{OUT} OVP Rising and Falling Threshold vs. Temperature

V_{IN} OVP Rising and Falling Threshold vs. Temperature

EN Rising and Falling Threshold vs. Temperature

Peak Current Limit vs. Temperature

TYPICAL PERFORMANCE CHARACTERISTICS

V_{IN} = 5V, V_{OUT} = 1.2V, L = 1 μ H, C_{OUT} = 22 μ F, T_A = +25°C, unless otherwise noted.

Steady State

I_{OUT} = 0A

CH1:
V_{OUT}/AC
50mV/div.

CH2: V_{IN}
5V/div.

CH3: V_{SW}
5V/div.

CH4: I_L
1A/div.

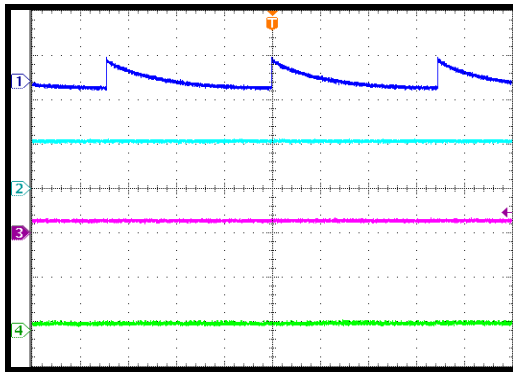

20ms/div.

Steady State

I_{OUT} = 1A

CH1:
V_{OUT}/AC
10mV/div.

CH2: V_{IN}
5V/div.

CH3: V_{SW}
5V/div.

CH4: I_L
1A/div.

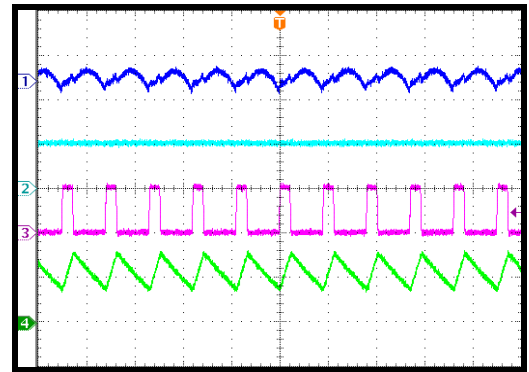

1 μ s/div.

Load Transient Response

I_{OUT} = 0 - 1A

CH1:
V_{OUT}/AC
100mV/div.

CH2: V_{IN}
5V/div.

CH3: V_{SW}
5V/div.

CH4: I_{OUT}
1A/div.

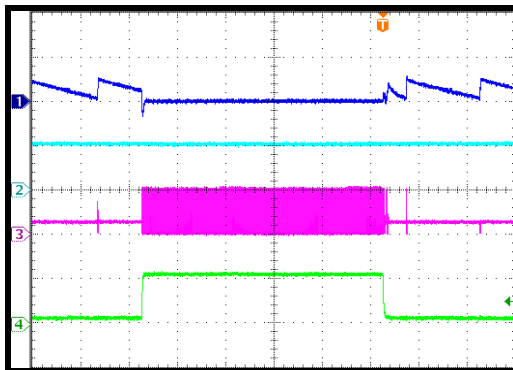

400 μ s/div.

Load Transient Response

I_{OUT} = 0.1 - 1A

CH1:
V_{OUT}/AC
20mV/div.

CH2: V_{IN}
5V/div.

CH3: V_{SW}
5V/div.

CH4: I_{OUT}
1A/div.

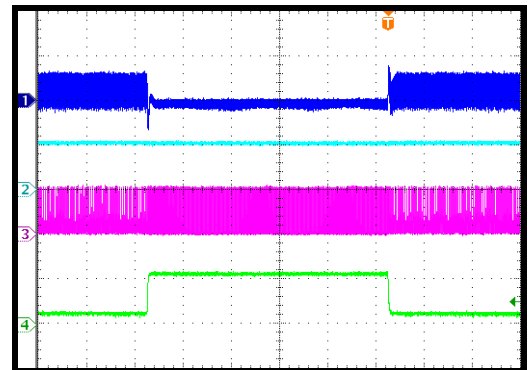

400 μ s/div.

EN Power-Up

I_{OUT} = 0A

CH1: V_{OUT}
1V/div.

CH2: V_{EN}
5V/div.

CH3: V_{SW}
5V/div.

CH4: I_L
1A/div.

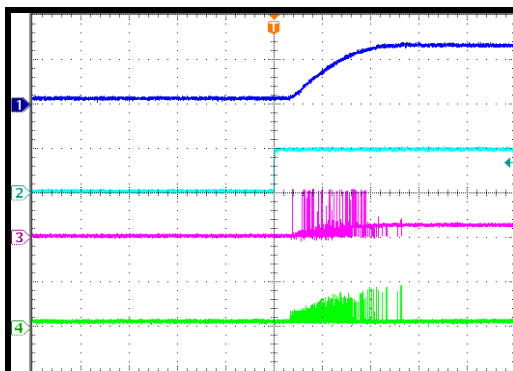

400 μ s/div.

EN Shutdown

I_{OUT} = 0A

CH1: V_{OUT}
1V/div.

CH2: V_{EN}
5V/div.

CH3: V_{SW}
5V/div.

CH4: I_L
1A/div.

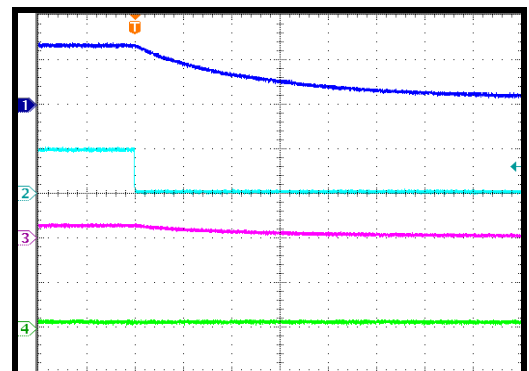

2ms/div.

TYPICAL PERFORMANCE CHARACTERISTICS (continued)

 V_{IN} = 5V, V_{OUT} = 1.2V, L = 1 μ H, C_{OUT} = 22 μ F, T_A = +25°C, unless otherwise noted.

EN Power-Up

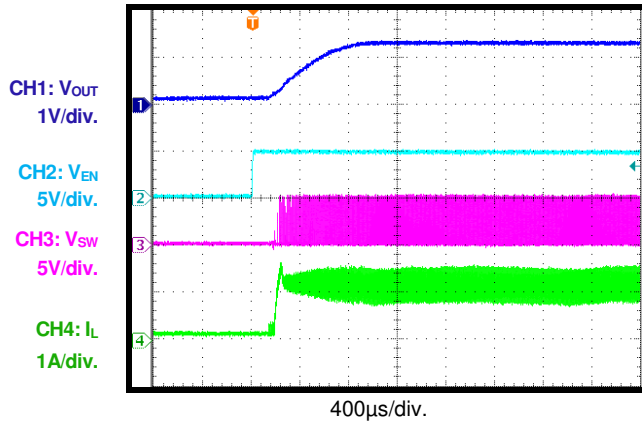
 I_{OUT} = 1A

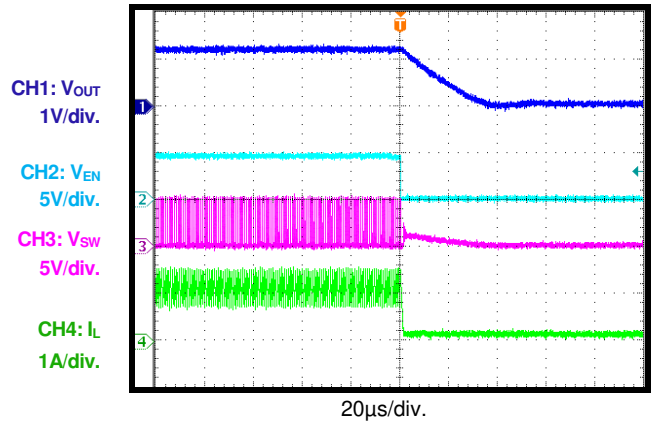
EN Shutdown

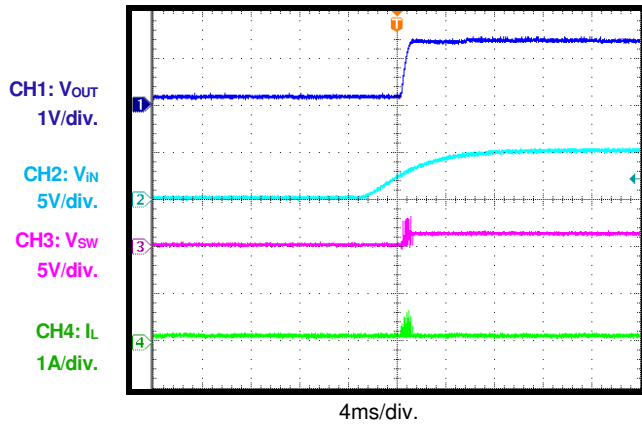
 I_{OUT} = 1A

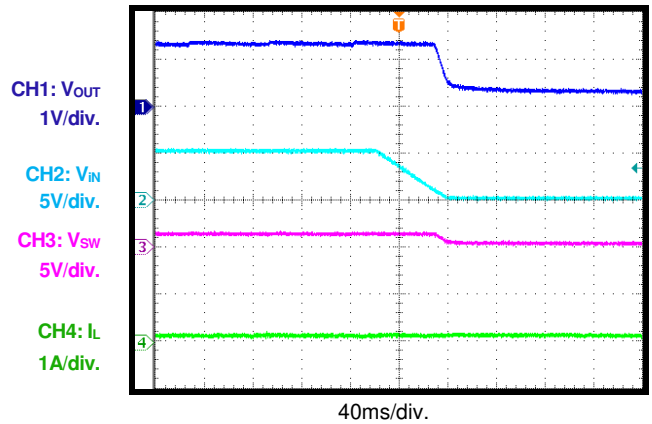
V_{IN} Power-Up

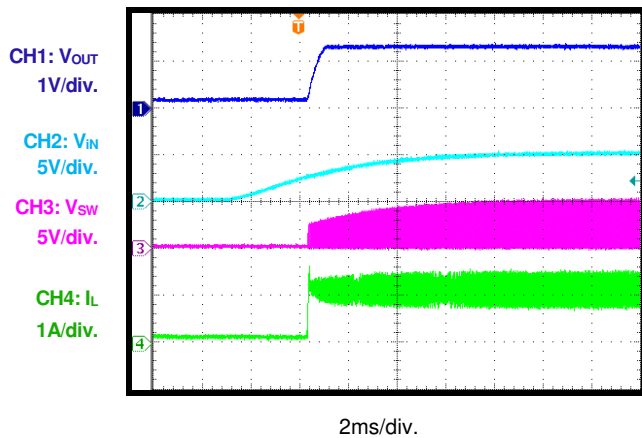
 I_{OUT} = 0A

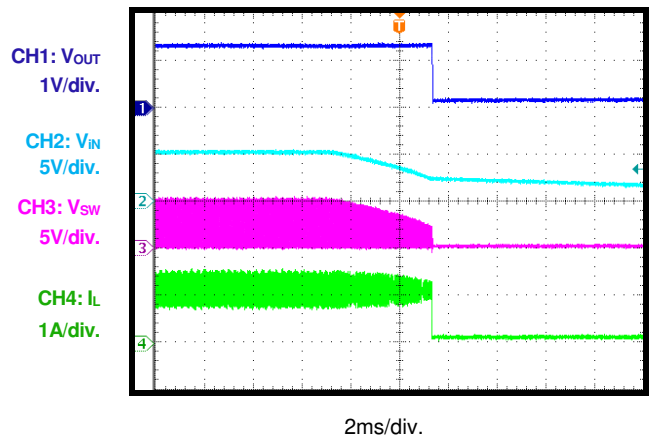
V_{IN} Shutdown

 I_{OUT} = 0A

V_{IN} Power-Up

 I_{OUT} = 1A

V_{IN} Shutdown

 I_{OUT} = 1A

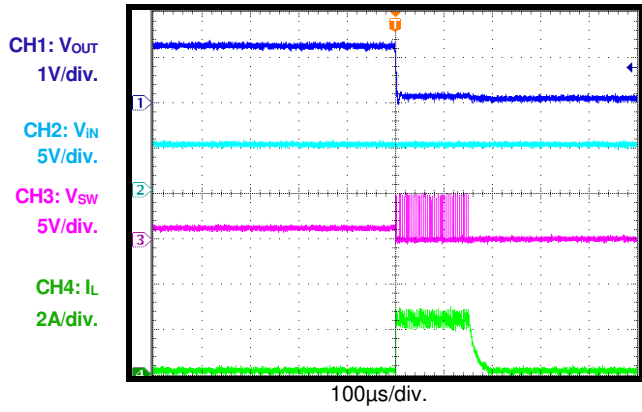
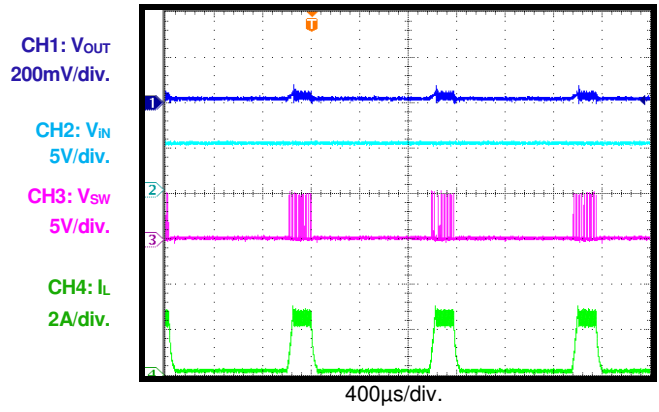
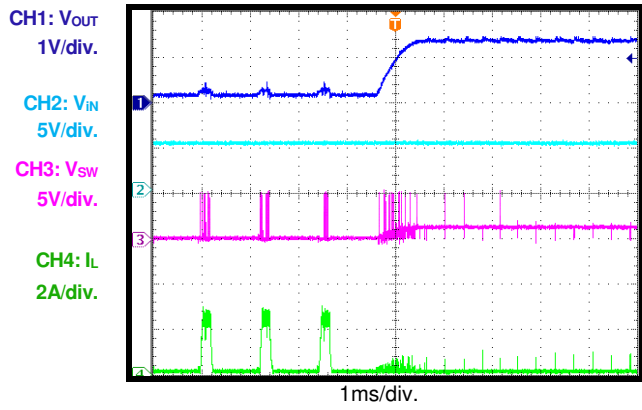
TYPICAL PERFORMANCE CHARACTERISTICS (continued)

 V_{IN} = 5V, V_{OUT} = 1.2V, L = 1 μ H, C_{OUT} = 22 μ F, T_A = +25°C, unless otherwise noted.

Short-Circuit Entry

Short-Circuit State

Short-Circuit Recovery

BLOCK DIAGRAM

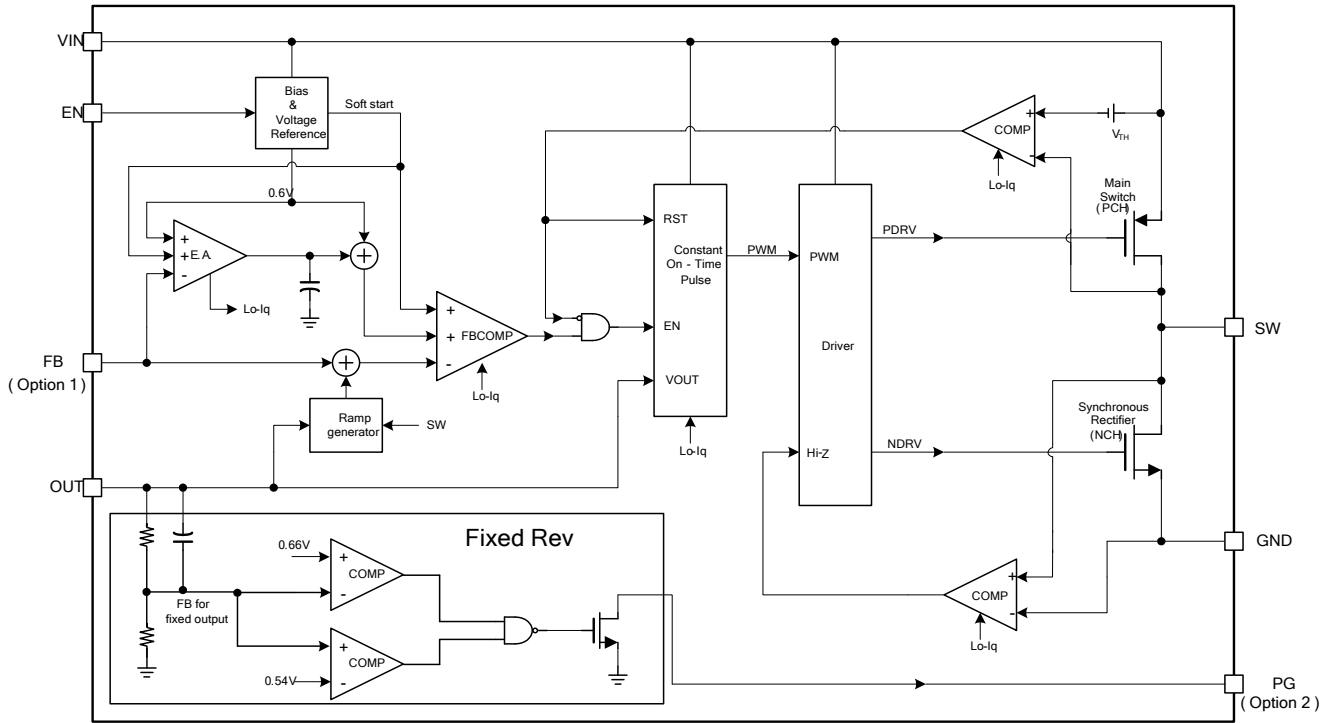

Figure 1: Functional Block Diagram

Option 1: FB is only for MP2151XXX.
 Option 2: PG is only for MP2151XXX-XX.

OPERATION

The MP2151 uses constant-on-time (COT) control with input voltage feed-forward to stabilize the switching frequency over the entire input range. The MP2151 achieves 1A of continuous output current from a 2.5V to 5.5V input voltage with excellent load and line regulation. The output voltage can be regulated as low as 0.6V.

Constant-On-Time (COT) Control

Compare to fixed-frequency pulse-width modulation (PWM) control, COT control offers a simpler control loop and faster transient response. By using input voltage feed-forward, the MP2151 maintains a fairly constant switching frequency across the input and output voltage ranges. The switching pulse on time can be estimated with Equation (1):

$$T_{ON} = \frac{V_{OUT}}{V_{IN}} \cdot 0.91\mu s \quad (1)$$

To prevent inductor current runaway during the load transient, the MP2151 has a fixed minimum off time of 100ns.

Sleep Mode Operation

The MP2151 features sleep mode to achieve high efficiency at extremely light-load conditions. In sleep mode, most of the circuit blocks are turned off, except for the error amplifier and PWM comparator, so the operation current is reduced to a minimal value (see Figure 2).

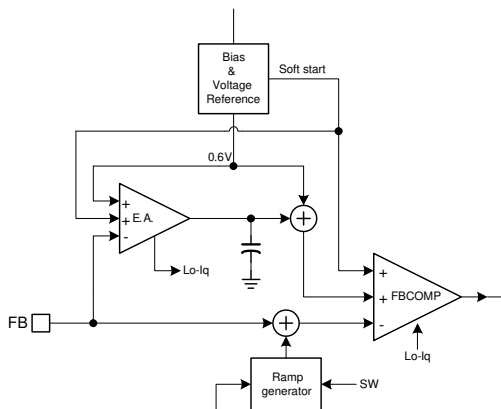

Figure 2: Operation Blocks in Sleep Mode

When the load lightens, the ripple of the output voltage increases and drives the error amplifier output (EAO) lower. When the EAO reaches an internal low threshold, it is clamped at that level,

and the MP2151 enters sleep mode. During sleep mode, the valley of the FB voltage is regulated to the internal reference voltage. Therefore, the average output voltage is slightly higher than the output voltage at discontinuous conduction mode (DCM) or continuous conduction mode (CCM). The on time pulse in sleep mode is slightly larger than that in DCM or CCM. Figure 3 shows the average FB voltage in relation to the internal reference in sleep mode.

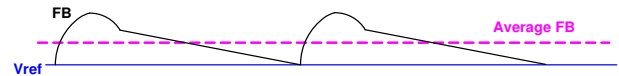

Figure 3: FB Average Voltage in Sleep Mode

When the MP2151 is in sleep mode, the average output voltage is higher than the internal reference voltage. The EAO is kept low and clamped in sleep mode. When the load increases, the PWM switching period decreases to keep the output voltage regulated. The output voltage ripple is decreased relatively. Once the EAO is higher than the internal low threshold, the MP2151 exits sleep mode and enters either DCM or CCM depending on the load. In DCM or CCM, the error amplifier regulates the average output voltage to the internal reference (see Figure 4).

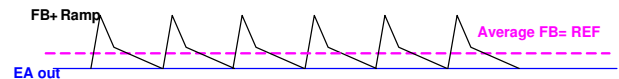

Figure 4: DCM Control

There is always a load hysteresis when entering and exiting sleep mode due to the error amplifier clamping response time.

AAM Operation at Light-Load Operation

The MP2151 uses advanced asynchronous modulation (AAM) power-save mode together with a zero-current cross detection (ZCD) circuit in light-load operation.

The simplified AAM control theory is shown in Figure 5. The AAM current (I_{AAM}) is set internally. The SW on pulse time is determined by the on-time generator and AAM comparator. In light-load condition, the SW on pulse time is the longer pulse. If the AAM comparator pulse is longer than the on-time generator, the operation mode is as shown in Figure 6.

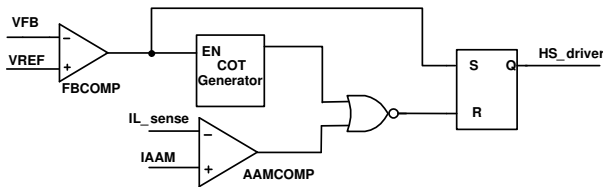
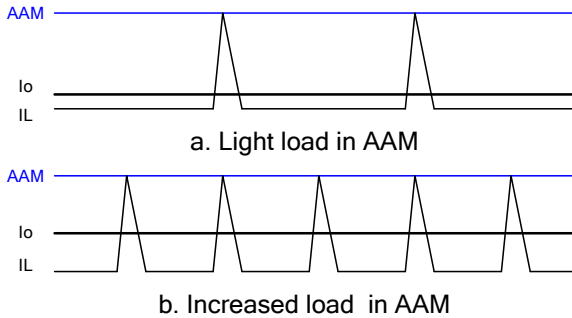
Figure 5: Simplified AAM Control Logic

Figure 6: AAM Comparator Control T_{ON}

If the AAM comparator pulse is shorter than the on-time generator, the operation mode is as shown in Figure 7.

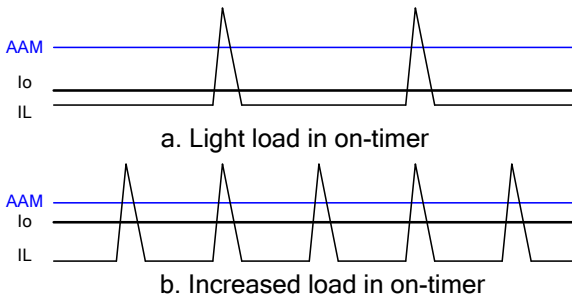
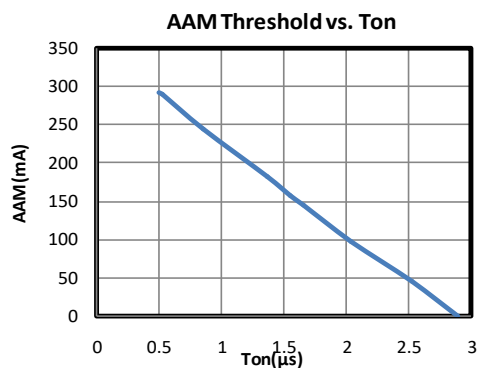

Figure 7: On-Time Control T_{ON}

Figure 8 shows the AAM threshold decreasing as T_{ON} increases gradually. In CCM, I_o must be more than half of the AAM threshold at least. Generally, the AAM threshold is lower than the inductor current in a normal duty cycle.

Figure 8: AAM Threshold Decreasing as T_{ON} Increases

The MP2151 ZCD determines when the inductor current starts reversing. When the inductor current reaches the ZCD threshold, the low-side switch is turned off.

AAM mode together with the ZCD circuit makes the MP2151 always operate in DCM in light-load conditions, even if V_o is close to V_{IN}.

Enable (EN)

When the input voltage is greater than the under-voltage lockout (UVLO) threshold (typically 2.3V), the MP2151 can be enabled by pulling EN above 1.2V. Leave EN floating or pull EN down to ground to disable the MP2151. There is an internal 1M Ω resistor from EN to ground.

When the MP2151 is disabled, it goes into output discharge mode automatically. The internal discharge MOSFET provides a resistive discharge path for the output capacitor.

Soft Start

The MP2151 has a built-in soft start that ramps up the output voltage at a controlled slew rate to avoid overshooting during start-up. The soft-start time is about 0.5ms, typically.

Current Limit

The MP2151 has a minimum 1.8A high-side switch current limit, typically. When the high-side switch reaches its current limit, the MP2151 is in hiccup mode until the current drops. This prevents the inductor current from continuing to rise and damaging components.

Short Circuit and Recovery

The MP2151 also enters short-circuit protection (SCP) mode when it reaches the current limit and attempts to recover with hiccup mode. In hiccup mode, the MP2151 disables the output power stage, discharges the soft-start capacitor, and attempts to soft start again automatically. If the short-circuit condition remains after the soft start ends, the MP2151 repeats this cycle until the short circuit is removed and the output rises back to the regulation level.

Over-Voltage Protection (V_o OVP)

The MP2151 monitors the feedback voltage to detect an over-voltage condition. When the feedback voltage rises higher than 115% of the target voltage, the controller enters a dynamic

regulation period. During this period, the low side is on until the low-side current drops to -1.5A. This discharges the output to keep it within the normal range. If the over-current condition still remains, the low side turns on again after a 1 μ s delay. The MP2151 exits this regulation period when the feedback voltage drops below 105% of the reference voltage. If the dynamic regulation cannot limit the increasing of V_O, once the input detects that a 6.1V input over-voltage protection (OVP) has occurred, the MP2151 stops switching until the input voltage drops below 5.7V. The MP2151 then resumes operation.

Power Good (PG) Indicator (only for MP2151XXX-XX)

The MP2151XXX-XX has an open-drain output and requires an external pull-up resistor (100 ~ 500k Ω) for the power good (PG) indicator. When the feedback voltage is within -10%/+15% of the regulation voltage, V_{PG} is pulled up to V_{OUT}/V_{IN} by the external resistor. If the feedback voltage exceeds this window, the internal MOSFET pulls PG to ground. The MOSFET has a maximum R_{DS(ON)} of less than 400 Ω .

APPLICATION INFORMATION

Setting the Output Voltage

The external resistor divider sets the output voltage. Select a feedback resistor (R1) that will reduce the V_o leakage current (typically 100 - 200kΩ). There is no strict requirement for the feedback resistor. An R1 value greater than 10kΩ is reasonable for most applications. R2 can then be calculated with Equation (2):

$$R2 = \frac{R1}{\frac{V_{out}}{0.6} - 1} \quad (2)$$

Figure 9 shows the feedback circuit.

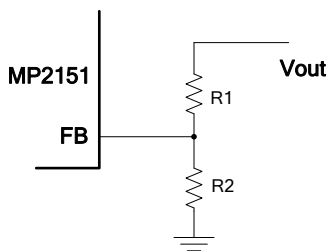

Figure 9: Feedback Network

Table 1 lists the recommended resistor values for common output voltages.

Table 1: Resistor Values for Common Output Voltages

V _{OUT} (V)	R1 (kΩ)	R2 (kΩ)
1.0	200 (1%)	300 (1%)
1.2	200 (1%)	200 (1%)
1.8	200 (1%)	100 (1%)
2.5	200 (1%)	63.2 (1%)
3.3	200 (1%)	44.2 (1%)

Selecting the Inductor

Most applications work best with a 1 - 2.2µH inductor. Select an inductor with a DC resistance less than 50mΩ to optimize efficiency.

A high-frequency, switch-mode power supply with a magnetic device produces a strong electronic magnetic interference in the system. Avoid applying any unshielded power inductor due to poor magnetic shielding. Any shield inductor, such as metal alloy or multilayer chip power, are ideal for applications as they can decrease the influence effectively. Table 2 lists some recommended inductors.

Table 2: Recommended Inductors

Manufacturer P/N	Inductance (µH)	Manufacturer
PIFE25201B-1R0MS	1.0	CYNTEC CO. LTD.
74437324010	1.0	Würth

For most designs, estimate the inductance value with Equation (3):

$$L_1 = \frac{V_{OUT} \times (V_{IN} - V_{OUT})}{V_{IN} \times \Delta I_L \times f_{OSC}} \quad (3)$$

Where ΔI_L is the inductor ripple current.

Choose an inductor current that is approximately 30% of the maximum load current. The maximum inductor peak current can be calculated with Equation (4):

$$I_{L(MAX)} = I_{LOAD} + \frac{\Delta I_L}{2} \quad (4)$$

Selecting the Input Capacitor

The input current to the step-down converter is discontinuous and therefore requires a capacitor to supply AC current to the step-down converter while maintaining the DC input voltage. Use low ESR capacitors for the best performance. Ceramic capacitors with X5R or X7R dielectrics are highly recommended because of their low ESR and small temperature coefficients. For most applications, a 22µF capacitor is sufficient. Higher output voltages may require a 44µF capacitor to increase system stability.

The input capacitor requires an adequate ripple current rating since it absorbs the input switching current. Estimate the RMS current in the input capacitor with Equation (5):

$$I_{C1} = I_{LOAD} \times \sqrt{\frac{V_{OUT}}{V_{IN}} \times \left(1 - \frac{V_{OUT}}{V_{IN}}\right)} \quad (5)$$

The worst-case condition occurs at V_{IN} = 2V_{OUT}, shown in Equation (6):

$$I_{C1} = \frac{I_{LOAD}}{2} \quad (6)$$

For simplification, choose an input capacitor with an RMS current rating greater than half of the maximum load current. The input capacitor

can be electrolytic, tantalum, or ceramic. When using electrolytic or tantalum capacitors, add a small, high-quality, ceramic, 0.1µF capacitor as close to the IC as possible.

When using ceramic capacitors, ensure that they have enough capacitance to provide a sufficient charge to prevent an excessive voltage ripple at the input. The input voltage ripple caused by the capacitance can be estimated with Equation (7):

$$\Delta V_{IN} = \frac{I_{LOAD}}{f_s \times C1} \times \frac{V_{OUT}}{V_{IN}} \times \left(1 - \frac{V_{OUT}}{V_{IN}}\right) \quad (7)$$

Selecting the Output Capacitor

The output capacitor (C2) stabilizes the DC output voltage. Low ESR ceramic capacitors are recommended to limit the output voltage ripple. Estimate the output voltage ripple with Equation (8):

$$\Delta V_{OUT} = \frac{V_{OUT}}{f_s \times L_1} \times \left(1 - \frac{V_{OUT}}{V_{IN}}\right) \times \left(R_{ESR} + \frac{1}{8 \times f_s \times C2}\right) \quad (8)$$

Where L₁ is the inductor value, and R_{ESR} is the equivalent series resistance (ESR) value of the output capacitor.

When using ceramic capacitors, the capacitance dominates the impedance at the switching frequency and causes most of the output voltage ripple. For simplification, the output voltage ripple can be estimated with Equation (9):

$$\Delta V_{OUT} = \frac{V_{OUT}}{8 \times f_s^2 \times L_1 \times C2} \times \left(1 - \frac{V_{OUT}}{V_{IN}}\right) \quad (9)$$

For tantalum or electrolytic capacitors, the ESR dominates the impedance at the switching frequency. For simplification, the output ripple can be approximated with Equation (10):

$$\Delta V_{OUT} = \frac{V_{OUT}}{f_s \times L_1} \times \left(1 - \frac{V_{OUT}}{V_{IN}}\right) \times R_{ESR} \quad (10)$$

The characteristics of the output capacitor also affect the stability of the regulation system.

PCB Layout Guidelines

Efficient layout of the switching power supplies is critical for stable operation. For the high-frequency switching converter, a poor layout design can result in poor line or load regulation and stability issues. For best results, refer to Figure 10 and follow the guidelines below.

1. Place the high-current paths (GND, VIN, and SW) very close to the device with short, direct, and wide traces.
2. Place the input capacitor as close to VIN and GND as possible.
3. Place the external feedback resistors next to FB.
4. Keep the switching node SW short and away from the feedback network.
5. Keep the VOUT sense line as short as possible or away from the power inductor, especially the surrounding inductor.

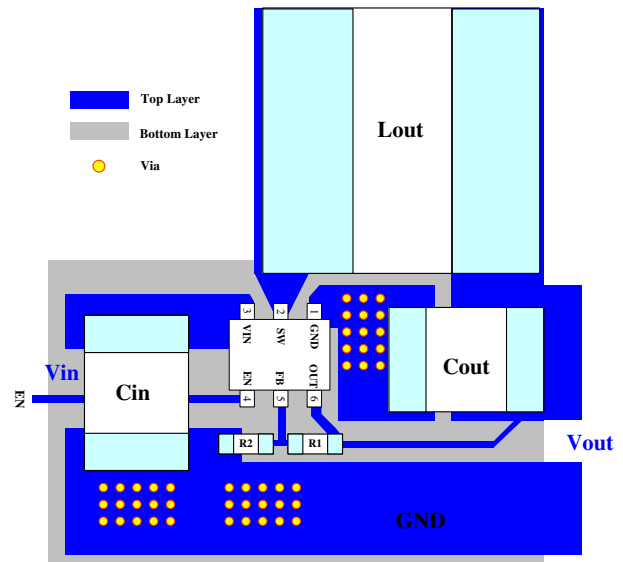

Figure 10: Recommended Layout for MP2151GTF

TYPICAL APPLICATION CIRCUITS

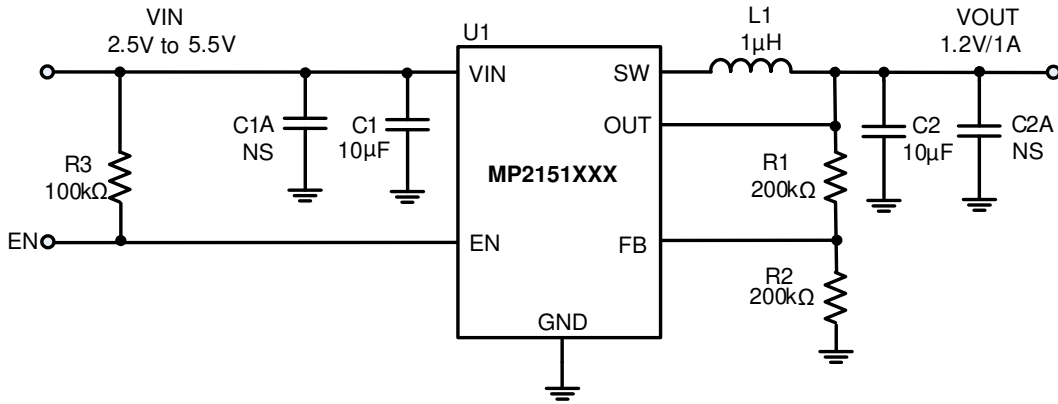

Figure 11: Typical Application Circuit for MP2151XXX

NOTE: VIN < 3.3V applications may require more input capacitors.

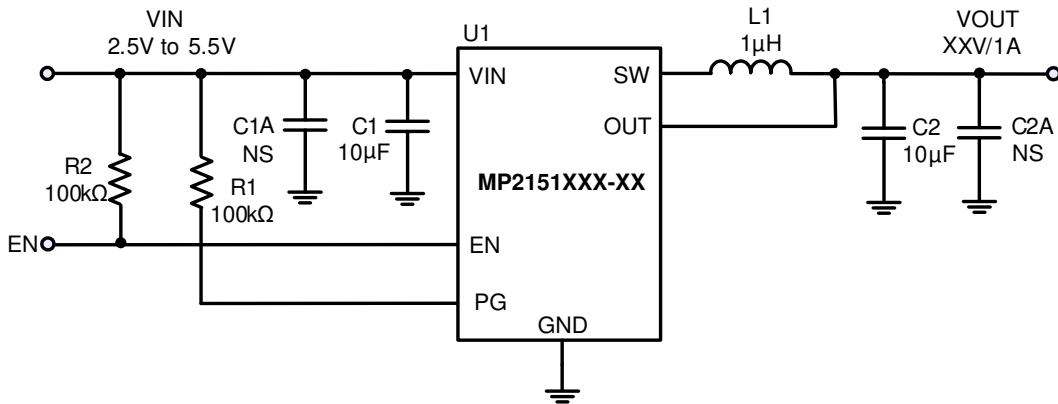
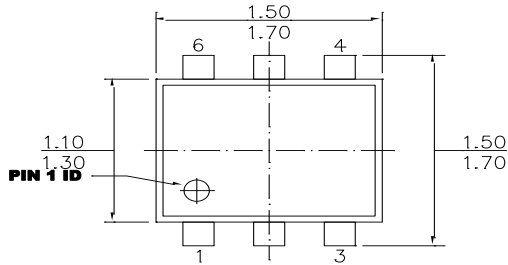

Figure 12: Typical Application Circuit for MP2151XXX-XX

NOTE: VIN < 3.3V applications may require more input capacitors.

PACKAGE INFORMATION

SOT563



TOP VIEW

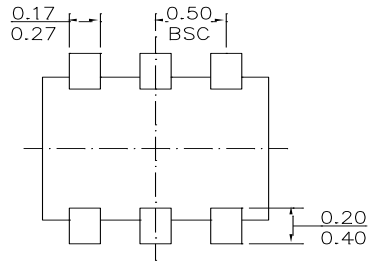

BOTTOM VIEW

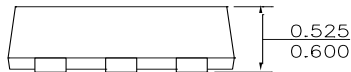

FRONT VIEW

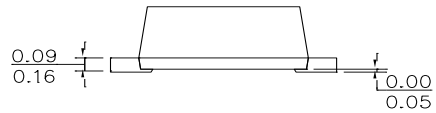

SIDE VIEW

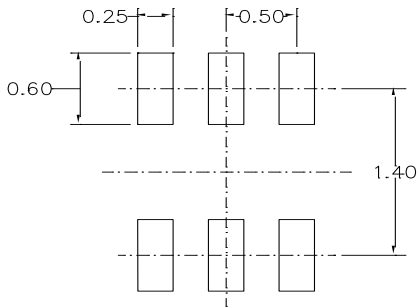

RECOMMENDED LAND PATTERN

NOTE:

- 1) ALL DIMENSIONS ARE IN MILLIMETERS.
- 2) PACKAGE LENGTH DOES NOT INCLUDE MOLD FLASH, PROTRUSION OR GATE BURR.
- 3) PACKAGE WIDTH DOES NOT INCLUDE INTERLEAD FLASH OR PROTRUSION.
- 4) LEAD COPLANARITY (BOTTOM OF LEADS AFTER FORMING) SHALL BE 0.10 MILLIMETERS MAX.
- 5) DRAWING IS NOT TO SCALE.

PACKAGE INFORMATION (continued)

UTQFN (1.2mmx1.6mm)

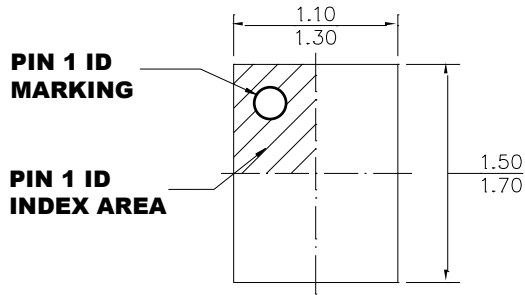

TOP VIEW

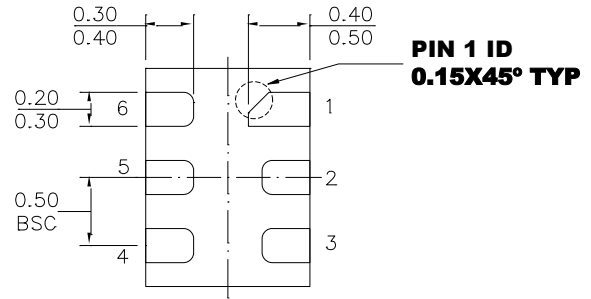

BOTTOM VIEW

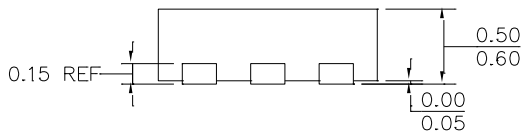

SIDE VIEW

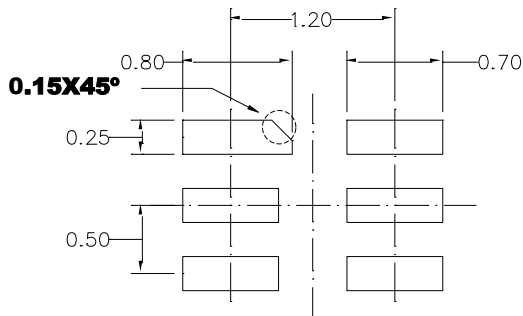

RECOMMENDED LAND PATTERN

NOTE:

- 1) ALL DIMENSIONS ARE IN MILLIMETERS.
- 2) LEAD COPLANARITY SHALL BE 0.08 MILLIMETERS MAX.
- 3) JEDEC REFERENCE IS MO-220.
- 4) DRAWING IS NOT TO SCALE.

NOTICE: The information in this document is subject to change without notice. Please contact MPS for current specifications. Users should warrant and guarantee that third party Intellectual Property rights are not infringed upon when integrating MPS products into any application. MPS will not assume any legal responsibility for any said applications.