

General information

Part number	S41F1C-P08MFG0-400S
Termination	solder
Size	1
Locking principle	push
Coding	1_halfshell
Cable Diameter	cable_mini_40
Cable outlet	bend_relief

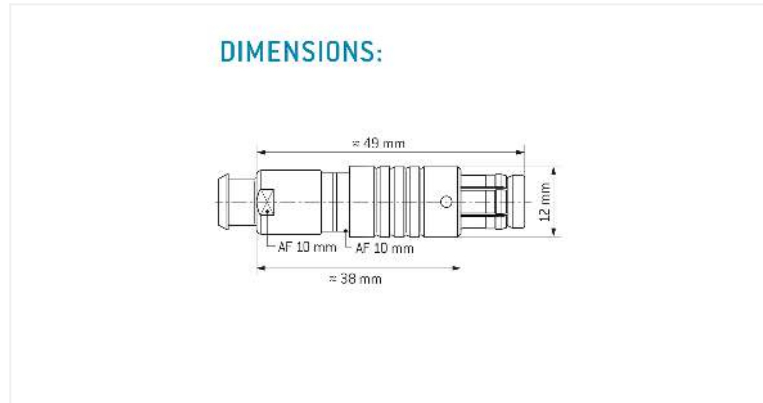
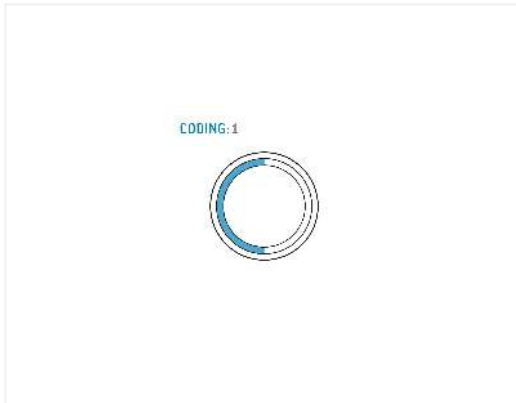

Contact insert description

Number of contacts	8
Contact type	pins
Contact diameter	07mm
Insulator material	peek
Wire cross section	22_awg
Termination	solder
Termination diameter	085mm

reverse_gender_on_request

Technical information

Max. creepage and air clearance distance	04_mm	07_mm
Nominal current single contact	075_a	iec_60512_5_2
Nominal current insert	4,875 A	vde_0298_4
Test voltage	09_kv_ac	sae_13441

safety_text

Mechanical and environmental data

Degree of protection*	ip68
Operating temperature	40_120_c
Mating cycles	5000

mated

Material and surface treatments

Housing	m_chrome
Contact	cu_alloy_gold

safety_text_2
ul_text
illustrative_text