

MC8038 series

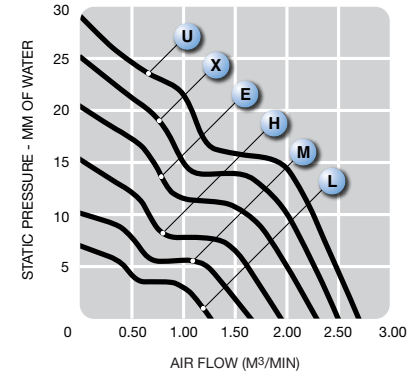
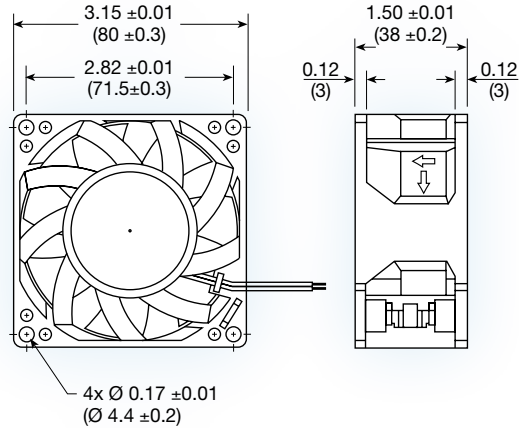

(80 x 80 x 38 mm)
3.15 x 3.15 x 1.50 inches

Construction: UL94V-0 PBT impeller & frame

Bearing option: ball bearing

Connection: AWG 26, UL1007 lead wires

Frame: flanged

Protection: thermal

Options: tachometer output or locked rotor alarm signal; PWM speed control

Model No.	Rated Voltage V	Current mA			Speed RPM	Air Volume		Max. Static Pressure (H ₂ O)		Sound Noise dB _A	Weight g
		12	24	48		M ³ /Min.	CFM	MM	INCH		
MC8038L	12/24/48	240	140	90	3,400	1.28	45.3	7.23	0.28	39.0	180
MC8038M	12/24/48	370	230	140	4,200	1.63	57.5	10.30	0.41	44.5	180
MC8038H	12/24/48	610	330	190	5,000	1.98	69.9	15.62	0.61	48.2	180
MC8038E	12/24/48	930	450	280	5,800	2.31	81.6	21.38	0.84	52.1	180
MC8038X	12/24	1200	600	-	6,300	2.51	86.6	25.22	0.99	56.4	180
MC8038U	12/24	1500	890	-	6,800	2.71	95.6	29.38	1.15	60.2	180