

FEATURES

- Full-featured evaluation board for the AD7792**
- Standalone USB interface**
- Various linking options**
- PC software for control of AD7792**

GENERAL DESCRIPTION

This data sheet describes the evaluation board for the [AD7792](#), which is a low power, 16-bit sigma-delta (Σ - Δ) ADC. The AD7792 is a complete analog front end for low frequency measurement applications. It contains three differential inputs and includes a low noise instrumentation amplifier, an embedded reference, and programmable current sources. The update rate can be varied from 4.17 Hz to 470 Hz. It also has an on-board clock, eliminating the need for an external clock. It employs a Σ - Δ conversion technique to realize up to 16 bits of no missing codes performance. The input signal is applied to an analog modulator. The modulator output is processed by an on-chip digital filter. The analog input channel of the AD7792 accepts analog input signals of $\pm V_{REF}/\text{gain}$, with gain equal to 1 to 128.

With a gain of 64 and the update rate programmed to 16.7 Hz, the rms noise is 85 nV. Simultaneous 50 Hz/60 Hz rejection is available at this data update rate also.

Full data on the AD7792 is available in the AD7792 data sheet available from Analog Devices, Inc., and should be consulted in conjunction with this data sheet when using the evaluation board.

The evaluation board interfaces to the USB port of an IBM-compatible PC. Software is available with the evaluation board that allows users to easily communicate with the AD7792.

Note that the AD7792 evaluation board software should be installed before connecting the AD7792 evaluation board to the PC.

Another component on the AD7792 evaluation board is the [ADP3303](#) high precision, low power, 3.3 V output voltage regulator, which is used to power the USB/SPI interface.

FUNCTIONAL BLOCK DIAGRAM

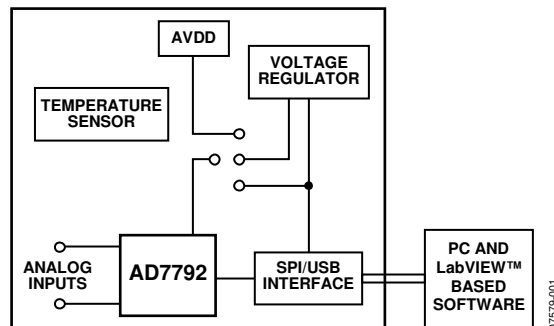

Figure 1.

Rev. 0

Evaluation boards are only intended for device evaluation and not for production purposes. Evaluation boards are supplied "as is" and without warranties of any kind, express, implied, or statutory including, but not limited to, any implied warranty of merchantability or fitness for a particular purpose. No license is granted by implication or otherwise under any patents or other intellectual property by application or use of evaluation boards. Information furnished by Analog Devices is believed to be accurate and reliable. However, no responsibility is assumed by Analog Devices for its use, nor for any infringements of patents or other rights of third parties that may result from its use. Analog Devices reserves the right to change devices or specifications at any time without notice. Trademarks and registered trademarks are the property of their respective owners. Evaluation boards are not authorized to be used in life support devices or systems.

TABLE OF CONTENTS

Features	1	Installing the Software.....	5
General Description	1	Using the Software	5
Functional Block Diagram	1	Main Window	6
Revision History	2	Registers Window	7
Evaluation Board Hardware.....	3	Other Registers Window	8
Power Supplies	3	Temp Demo Window	9
Links	3	Evaluation Board Schematic and Artwork.....	10
Setup Conditions	3	Ordering Information.....	14
Sockets	3	Bill of Materials.....	14
Interfacing to the Evaluation Board.....	4	Ordering Guide	14
Evaluation Board Software	5	ESD Caution.....	14
Software Description.....	5		

REVISION HISTORY

7/08—Revision 0: Initial Version

EVALUATION BOARD HARDWARE

POWER SUPPLIES

The AD7792 evaluation board is powered via the 5 V supply from the USB connector, J1. This 5 V supply can be used to power the AD7792 directly. A 3.3 V regulated voltage from the on-board ADP3303 (a high precision, low power, 3.3 V output voltage regulator) can also be used. Alternatively, the AD7792 can be powered using an external 3 V or 5 V power supply via J3.

LINKS

Seven link options must be set for the required operating setup before using the evaluation board. The functions of these link options are outlined in Table 1.

Table 1. Evaluation Board Link Settings

Link	Default	Description
LK1	In	This link is used to externally short AIN1(+) to AIN1(–). If V_{BIAS} is enabled and directed to AIN1(–), a noise analysis can be performed in this configuration. With this link out, an external voltage can be applied to AIN1(+)/AIN1(–) using the SMB connectors.
LK2 to LK6	Out	These links are used to connect the on-board temperature demonstration circuit to the ADC and must all be in place when attempting to measure the ambient temperature. When the on-board temperature demonstration circuit is selected in software, LK6 allows current from the on-chip current source of the AD7792 to flow through the temperature demonstration circuit. When LK4 and LK5 are in place, the 1 k Ω thermistor is connected to AIN2(+)/AIN2(–). When LK2 and LK3 are in place, the 5 k Ω precision resistor is used to generate the reference for the AD7792 so that a ratiometric configuration of the temperature demonstration circuit is achieved.
LK7	B	LK7 is used to select the power source for AV_{DD} on the AD7792. LK7 in Position A selects an external power supply, supplied via J3. LK7 in Position B selects the 3.3 V regulated output from the on-board ADP3303 voltage regulator. LK7 in Position C selects the 5 V supply from the USB connector, J1.

Table 2. Initial Link and Switch Positions

Link No.	Position	Function
LK1	In	AIN1(+) and AIN1(–) are shorted.
LK2 to LK3	Out	Internal reference is used.
LK4 to LK5	Out	AIN2(+) and AIN2(–) are not connected to the temperature demonstration circuit.
LK6	Out	IOOUT2 is not connected to the temperature demonstration circuit.
LK7	B	The 3.3 V supply is used as AV_{DD} for the AD7792.

Table 3. Socket Functions

Socket	Description
AIN1+	Subminiature BNC (SMB) Connector. The analog input signal for the AIN1(+) input of the AD7792 is applied to this socket.
AIN1–	Subminiature BNC (SMB) Connector. The analog input signal for the AIN1(–) input of the AD7792 is applied to this socket.
REFIN1+	Subminiature BNC (SMB) Connector. This socket is used in conjunction with REFIN1– to apply an external reference to the AD7792. The voltage for the REFIN(+) input of the AD7792 is applied to this socket.
REFIN1–	Subminiature BNC (SMB) Connector. This socket is used in conjunction with REFIN1+ to apply an external reference to the AD7792. The voltage for the REFIN(–) input of the AD7792 is applied to this socket.
J2	16-Pin (2 \times 8) Straight Header. This socket is used in conjunction with the prototype area to interface any signal to the AD7792.

SETUP CONDITIONS

Care should be taken before applying power and signals to the evaluation board to ensure that all link positions are set per the required operating mode. Table 2 shows the position in which all the links are initially set.

SOCKETS

There are five sockets relevant to the operation of the AD7792 on this evaluation board. The functions of these sockets are outlined in Table 3.

EVAL-AD7792

INTERFACING TO THE EVALUATION BOARD

Interfacing to the evaluation board is via a standard USB connector, J1. J1 is used to connect the evaluation board to the USB port of a PC. A standard USB connector cable is included with the AD7792 evaluation board to allow the evaluation board to interface with the USB port of the PC. Because the board is powered via the USB connector, there is no need for an external power supply, although if preferred, one may be connected via J3.

Communication between the [AD7792](#) and the PC is via the USB/SPI interface. The on-board USB controller (U2) handles this communication.

To set up the USB/SPI interface, use the following procedure:

1. Install the AD7792 evaluation board software using the supplied AD7792 evaluation board CD before connecting the board to the PC.
2. After the AD7792 evaluation board software is installed, connect the board to the PC via J1 on the AD7792 evaluation board and via the USB port on the PC using the supplied USB connector cable. The PC automatically finds the new USB device and identifies it as the **AD779x Evaluation Board**.
3. Follow the on-screen instructions that appear. During the installation process if the **Hardware Installation Wizard** appears as shown in Figure 2, select **Continue Anyway** to successfully complete the installation of the AD7792 evaluation board.



Figure 2. Hardware Installation Window

07579-002

EVALUATION BOARD SOFTWARE

SOFTWARE DESCRIPTION

The AD7792 evaluation board is shipped with a CD containing software that can be installed onto a standard PC to control the AD7792. The software communicates with the AD7792 through the USB cable, which accompanies the board. The software allows you to configure the AD7792 and to read conversion data from the AD7792. Data can be read from the AD7792 and displayed or stored for later analysis. For further information, see the AD7792 data sheet available from Analog Devices.

INSTALLATING THE SOFTWARE

Use the following steps to install the software:

1. Start Windows® and insert the CD.
2. The installation software should launch automatically. If it does not, use Windows Explorer to locate the **setup.exe** file on the CD. Double-click this file to start the installation procedure.
3. At the prompt, select a destination directory, which is **C:\Program Files\Analog Devices\AD7792** by default.

4. Once the directory is selected, the installation procedure copies the files into the relevant directories on the hard drive. The installation program creates a program group called **Analog Devices** with a subgroup **AD7792** in the **Start** menu of the taskbar.
5. Once the installation procedure is complete, double-click on the **AD7792** icon to start the program.

USING THE SOFTWARE

Figure 3 shows the main window that is displayed when the program starts. The Main Window section that follows briefly describes the various menu and button options in the main window. The Registers Window section, Other Registers Window section, and Temp Demo Window section describe the most commonly used evaluation software windows.

The data read can be exported to other packages, such as MathCAD™ or Microsoft® Excel, for further analysis.

During power-up, the AD7792 evaluation board software configures the device to have a gain of 64, the internal reference is selected, the AIN1(-)/AIN1(-) channel is selected, the bias voltage is enabled on AIN1(-), and the update rate is set to 16.7 Hz.

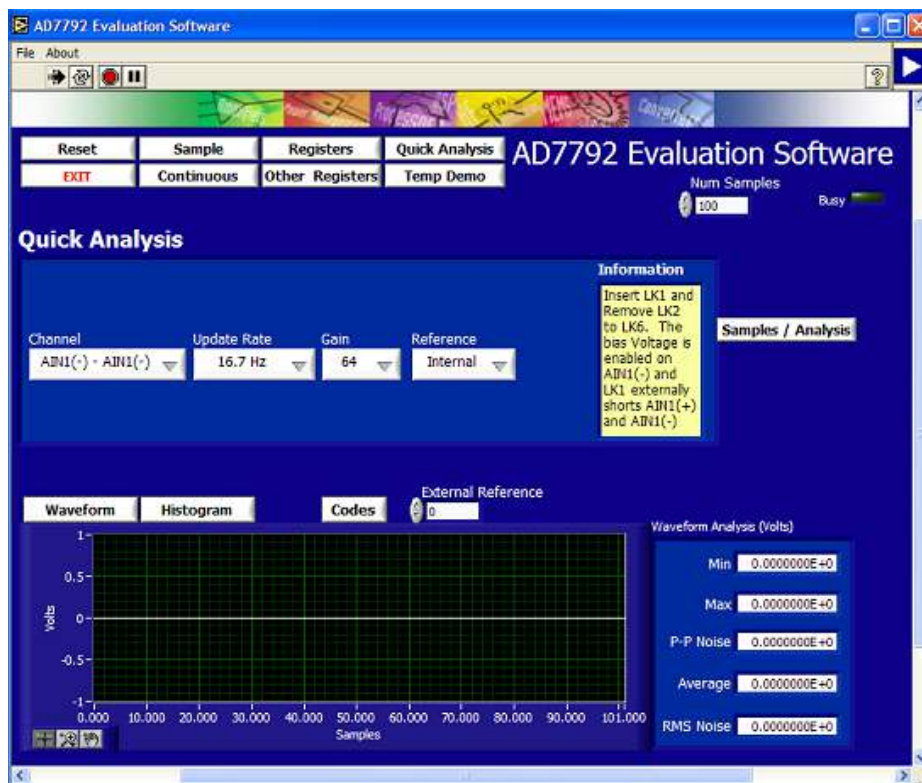

Figure 3. AD7792 Evaluation Software Main Window

MAIN WINDOW

Menu Bar

File

This allows the user to read previously stored data for display or analysis, write the current set of data to a file for later use, and exit the program.

About

This provides information on the revision of software used.

Buttons

Reset

This allows the user to reset the AD7792 and set the registers to the power-up conditions as specified by the software (channel = AIN1(-)/AIN1(-), bias voltage generator enabled on AIN1(-), gain = 64, update rate = 16.7 Hz, internal reference).

Exit

This allows the user to exit the software. It serves the same purpose as **Quit** in the **File** pull-down menu.

Sample

This allows the user to read a number of samples from the AD7792. Noise analysis is then performed on the samples. These samples can be stored for further analysis. The sample size is entered in the **Num Samples** text box.

Continuous

This allows the user to read a number of samples continuously. The software gathers a number of samples as specified by the **Num Samples** text box, performs noise analysis on the samples, and gathers the next group of samples.

Registers

This allows the user to access the configuration register, mode register, and IO register.

Other Registers

This allows the user to access the ID register, status register, offset register, and full-scale register.

Quick Analysis

This selects the **Quick Analysis** window. The **Quick Analysis** window gives the user access to the following subset of control bits: **Channel**, **Update Rate**, **Gain**, and **Reference**. For access to all control bits, click **Registers** or **Other Registers**.

Temp Demo

This allows the user to access the temperature demonstration software.

Samples/Analysis

This serves the same purpose as the **Sample** button.

Waveform

The gathered conversions are displayed in graph form.

Histogram

The gathered samples are used to generate a histogram

Codes

The gathered samples can be displayed in codes or in voltage format. When the **Codes** option is selected, the values are displayed as code. The **Codes** button changes to **Volts**. To display the information in volts, click **Volts**.

External Reference

By default, the internal reference is used. To use an external reference, set **Reference** in the **Registers** window to External. The value of the external reference should be entered in the **External Reference** text box.

REGISTERS WINDOW

Click **Registers** to access the **Registers** window (see Figure 4). You can now access the **Configuration Register**, **Mode Register**, and **IO Register**. This window allows you to change items such as the **Update Rate**, **Current Sources**, and the **Clock Source**. Consult the [AD7792](#) data sheet for further details on the bit functions.

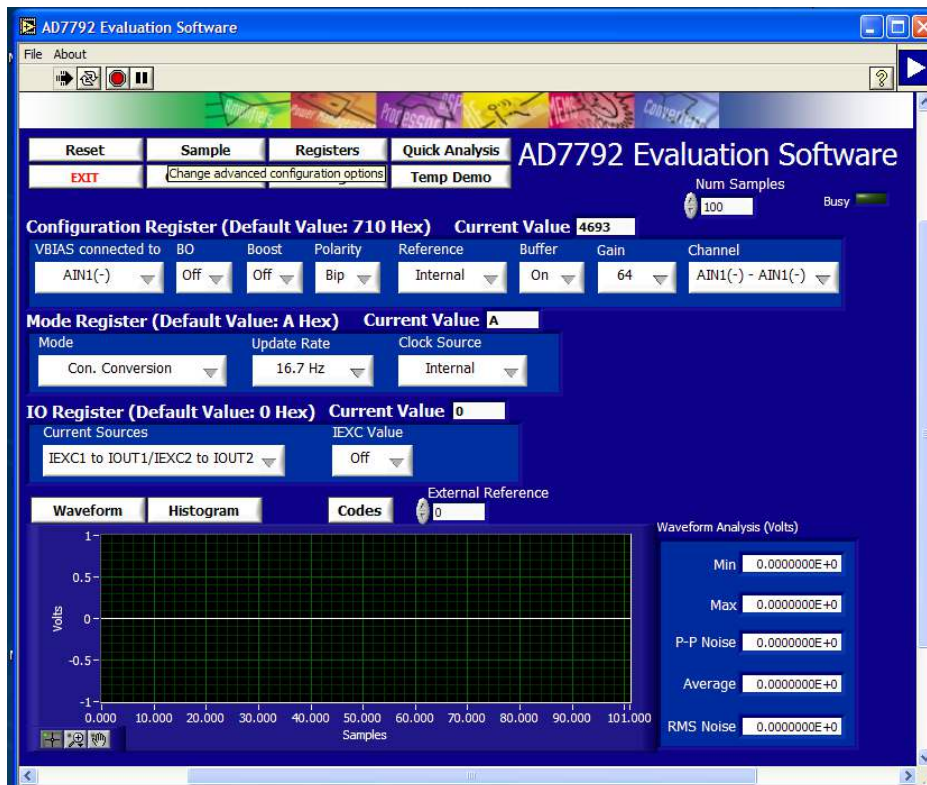

Figure 4. AD7792 Evaluation Software Registers Window

EVAL-AD7792

OTHER REGISTERS WINDOW

Click **Other Registers** to access the **Other Registers** window (see Figure 5). This window displays the contents of the **Offset Calibration Register**, **FS (Full-Scale) Calibration Register**, **ID Register**, and **Status Register**. To write to the Offset Calibration Register and FS Calibration Register, place the **AD7792** in power-down or idle mode (using the **Registers** window).

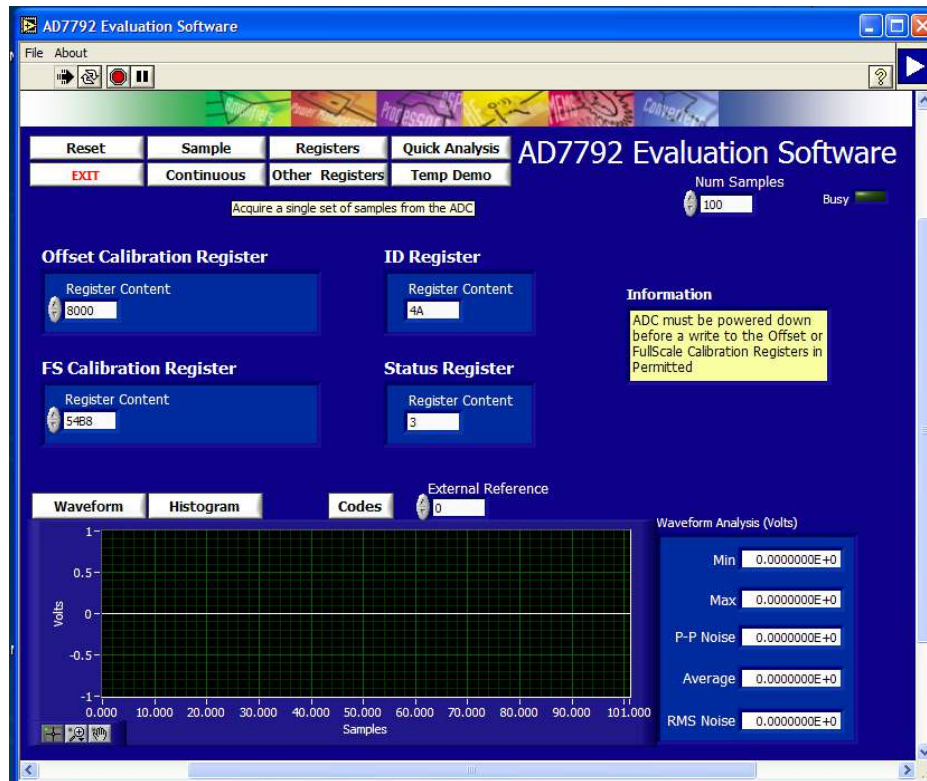

Figure 5. AD7792 Evaluation Software Other Registers Window

TEMP DEMO WINDOW

Click **Temp Demo** to access the **Temperature Demo** window (see Figure 6). The AD7792 evaluation board has a temperature demo included on the board. To operate the temperature demo, LK2 to LK6 should be inserted and LK1 removed. With these links in place, the excitation current of the AD7792 is connected to a 1 k Ω thermistor that is connected across the AIN2(+)/AIN2(-) pins. In series with the thermistor is a 5 k Ω precision resistor, which is used to generate the reference voltage so that a ratiometric configuration is used. The temperature demo software saves the values in the **Mode Register**, **Configuration Register**, and **IO**

Register. The software then configures the AD7792 to operate with a 210 μ A excitation current; the AIN2(+)/AIN2(-) channel is selected as the analog input, the gain is set to 1, and the external reference REFIN(+)/REFIN(-) is selected. The software continuously reads the conversion from the AIN2(+)/AIN2(-) channel and converts the result to temperature using a look-up table.

To exit the temperature demo, click the **BACK** button. The software sets the **Configuration Register**, **Mode Register**, and **I/O Register** to their pretemperature demonstration values.

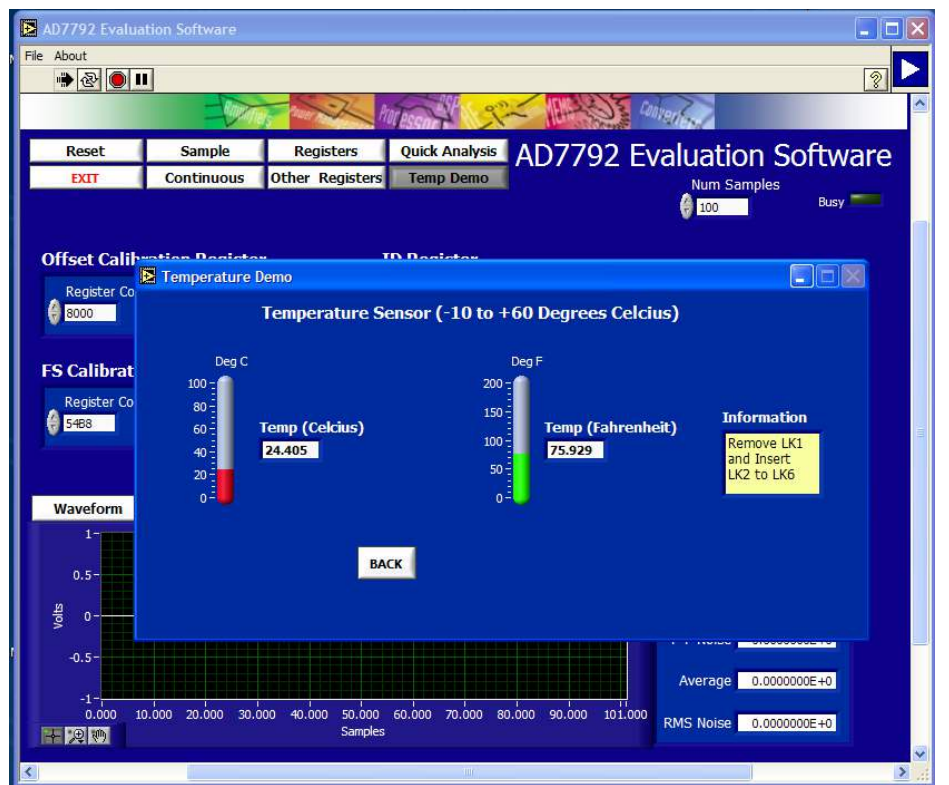
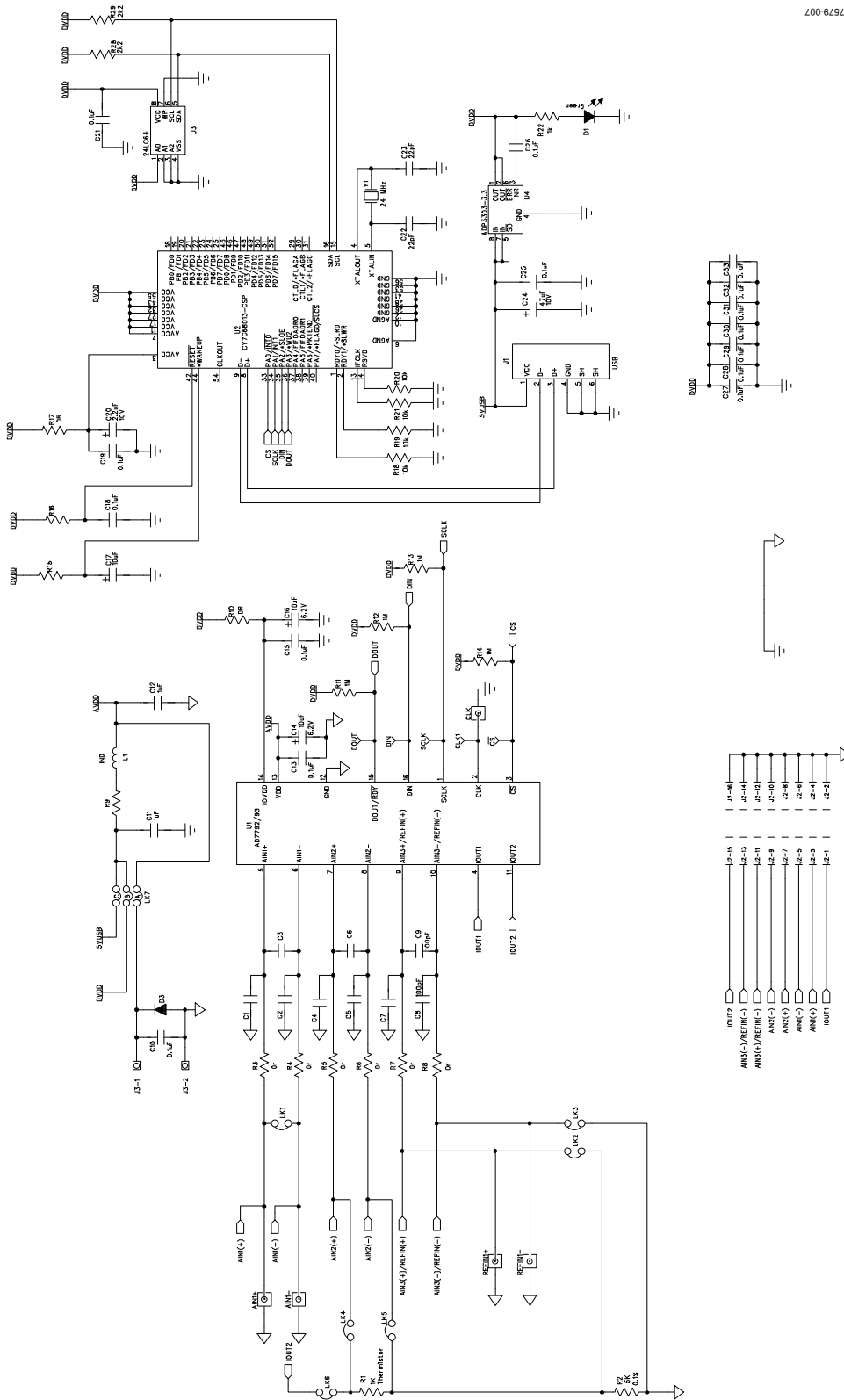

Figure 6. AD7792 Evaluation Software Temperature Demo Window

EVALUATION BOARD SCHEMATIC AND ARTWORK



07579-007

Figure 7. AD7792 Evaluation Board Schematic

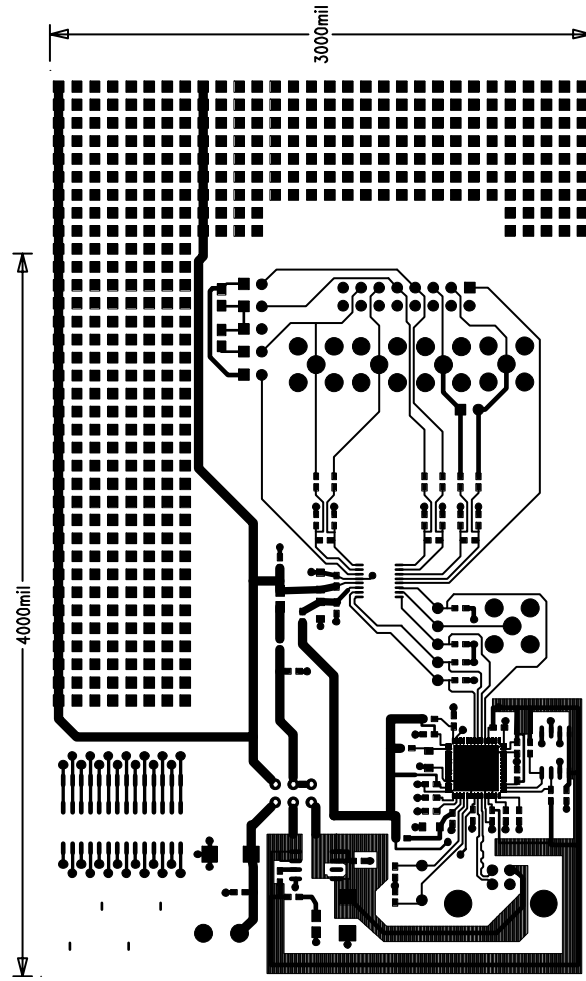

Figure 8. AD7792 Evaluation Board—Solder Side View

EVAL-AD7792

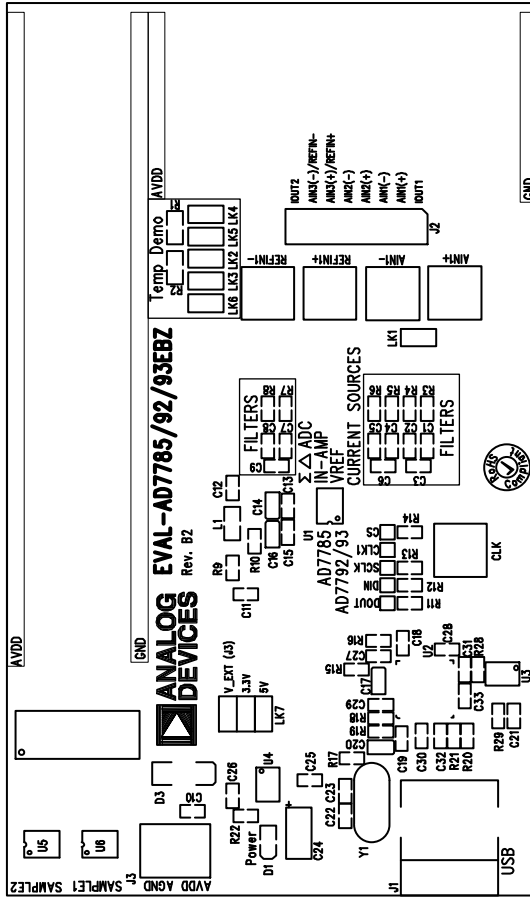
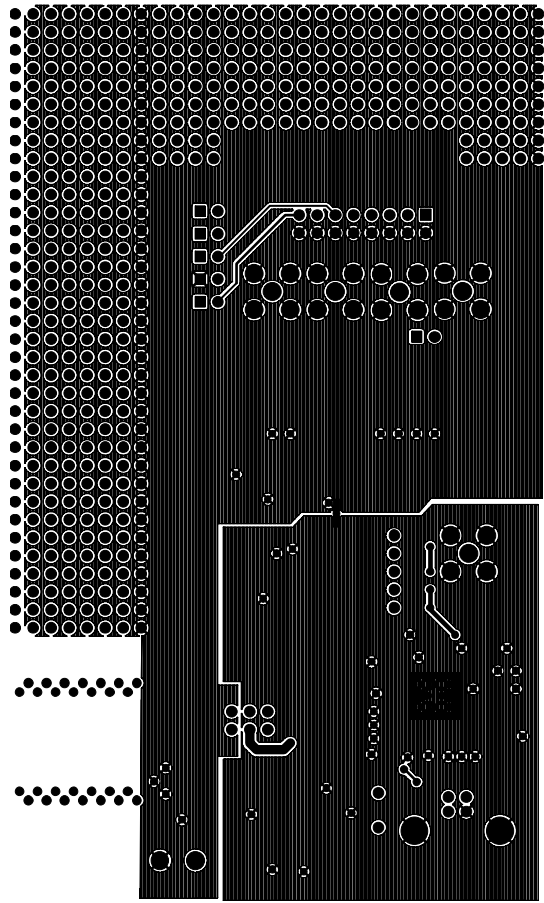

Figure 9. AD7792 Evaluation Board—Component Side View

07579-009



07579-010

Figure 10. AD7792 Evaluation Board—Component Layout Diagram

EVAL-AD7792

ORDERING INFORMATION

BILL OF MATERIALS

Table 4.

Qty	Reference Designator	Description	Manufacturer, Part No.
3	U1, U5, U6	AD7792BRUZ, IC	Analog Devices, AD7792BRUZ
1	U2	USB controller, IC	Cypress Semiconductor Corp., CY7C68013A-56LFXC
1	U3	24LC64, IC	Microchip Technology Inc., 24LC64-I/SN
1	U4	ADP3303ARZ-3.3, IC	Analog Devices, ADP3303ARZ-3.3
1	Y1	24 MHz crystal, IC	AEL Crystals, X24M0000005244
1	D1	Green LED, IC	Fairchild Semiconductor, QTLP630C-4
1	L1	Ferrite bead, IC	Meggitt Sigma, BMB2A0300AN1
1	D3	Diode, IC	Micro Commercial Components (MCC), DL4001-TP
9	C1 to C9	Capacitors	Not inserted
15	C10, C13, C15, C18, C19, C21, C25 to C33	0.1 μ F \pm 10% ceramic capacitors	AVX Corp., CM105X7R104K16AT
3	C14, C16, C17	10 μ F tantalum capacitors	AVX Corp., TAJA106K010R
2	C11, C12	1 μ F ceramic capacitors	Yageo Corp., 2238 246 19863
1	C20	2.2 μ F tantalum capacitor	EPCOS AG, B45196E2225K109
2	C22, C23	22 pF ceramic capacitors	Yageo Corp., 2238 867 15229
1	C24	47 μ F tantalum capacitor	AVX Corp., TAJC476K016R
1	R1	1 k Ω thermistor resistor	EPCOS AG, B57620C102J62
1	R2	5 k Ω \pm 0.1% resistor	Tyco Electronics Corp., RN73C2A4K99BTG
8	R3 to R8, R10, R17	0 Ω resistors	Multicomp, MC 0.063W, 0603, 0 Ω
1	R9	1.5 Ω resistor	Multicomp, MC 0.063W, 0603, 1.5 Ω
4	R11 to R14	1 M Ω resistors	Multicomp, MC 0.063W, 0603, 1%, 1 M Ω
2	R15, R16	100 k Ω resistors	Multicomp, MC 0.063W, 0603, 1%, 100 k Ω
4	R18 to R21	10 k Ω resistors	Multicomp, MC 0.063W, 0603, 1%, 10 k Ω
2	R28, R29	2.2 k Ω resistors	Multicomp, MC 0.063W, 0603, 1%, 2.2 k Ω
1	R22	1 k Ω resistor	Multicomp, MC 0.063W, 0603, 1%, 1 k Ω
7	LK1 to LK6 (2 \times 1 way), LK7 (3 \times 2 way)	Pin headers, links	Harwin Plc, M20-9983646
7	At LK1 to LK7	Shorting plugs, link	Harwin Plc, M7566-05
5	AIN1+, AIN1-, REFIN1+, REFIN1-, CLK	SMB connector	Not inserted
1	J1	USB Mini-B connector	Molex, 565790576
1	J2	16-pin (2 \times 8) header connector	Harwin Plc, M20-9983646
1	J3	2-way terminal block connector	Camden Electronics Ltd., CTB5000/2

ORDERING GUIDE

Model	Description
EVAL-AD7792EBZ ¹	Evaluation Board

¹ Z = RoHS Compliant Part.

ESD CAUTION



ESD (electrostatic discharge) sensitive device. Charged devices and circuit boards can discharge without detection. Although this product features patented or proprietary protection circuitry, damage may occur on devices subjected to high energy ESD. Therefore, proper ESD precautions should be taken to avoid performance degradation or loss of functionality.

NOTES

EVAL-AD7792

NOTES