

MAX6018

Precision, Micropower, 1.8V Supply, Low-Dropout, SOT23 Voltage Reference

General Description

The MAX6018 is a precision, low-voltage, low-dropout, micropower voltage reference in a SOT23 package. This three-terminal reference operates with an input voltage from ($V_{OUT} + 200\text{mV}$) to 5.5V, and is available with output voltage options of 1.2V, 1.6V, 1.8V, and 2.048V

The MAX6018 voltage reference consumes less than 5 μA (max) of supply current and can source and sink up to 1mA of load current. Unlike conventional shunt-mode (two-terminal) references that waste supply current and require an external resistor, devices in the MAX6018 family offer a supply current that is virtually independent of supply voltage (with only 0.1 $\mu\text{A/V}$ variation with supply voltage) and do not require an external resistor. The MAX6018 has initial accuracies of 0.2% (A grade) and 0.4% (B grade) and temperature drift of 50ppm/ $^{\circ}\text{C}$ (max). The low-dropout voltage and the ultra-low, supply voltage-independent supply current make this device ideal for two-cell alkaline, end-of-life, battery-monitoring systems. The MAX6018 is available in a tiny 3-pin SOT23 package.

Applications

- Two-Cell, Battery-Operated Systems
- Battery-Operated Equipment
- Hand-Held Equipment
- Data-Acquisition Systems
- Industrial and Process-Control Systems

Typical Application Circuit

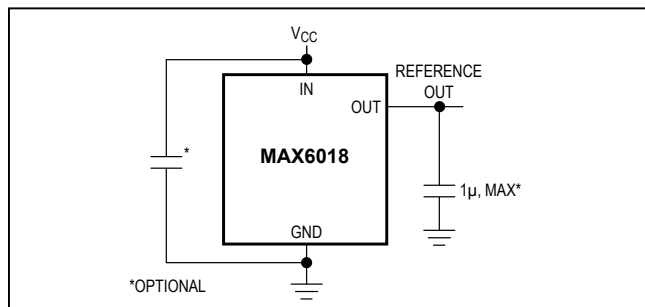

Pin Configuration

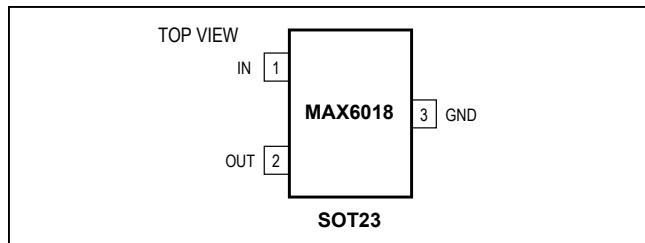

Benefits and Features

- Ultra-Low Supply Current: 5 μA (max)
- 1.6V Output from 1.8V Input
- Ultra-Small, 3-Pin SOT23 Package
- Initial Accuracy: $\pm 0.2\%$ (max)
- Low Temperature Drift: 50ppm/ $^{\circ}\text{C}$ (max)
- 200mV Dropout Voltage
- Load Regulation (1mA Source): 700 $\mu\text{V}/\text{mA}$ (max)
- Line Regulation ($V_{OUT} + 200\text{mV}$) to 5.5V: 250 $\mu\text{V}/\text{V}$ (max)
- Four Output Voltage Options: 1.2V, 1.6V, 1.8V, 2.048V

Ordering Information

PART	TEMP RANGE	PIN-PACKAGE	TOP MARK
MAX6018AEUR12+T	-40 $^{\circ}\text{C}$ to +85 $^{\circ}\text{C}$	3 SOT23-3	FZJH
MAX6018BEUR12+T	-40 $^{\circ}\text{C}$ to +85 $^{\circ}\text{C}$	3 SOT23-3	FZJI
MAX6018AEUR16+T	-40 $^{\circ}\text{C}$ to +85 $^{\circ}\text{C}$	3 SOT23-3	FZJJ
MAX6018BEUR16+T	-40 $^{\circ}\text{C}$ to +85 $^{\circ}\text{C}$	3 SOT23-3	FZJK
MAX6018AEUR18+T	-40 $^{\circ}\text{C}$ to +85 $^{\circ}\text{C}$	3 SOT23-3	FZJL
MAX6018BEUR18+T	-40 $^{\circ}\text{C}$ to +85 $^{\circ}\text{C}$	3 SOT23-3	FZJM
MAX6018AEUR21+T	-40 $^{\circ}\text{C}$ to +85 $^{\circ}\text{C}$	3 SOT23-3	FZJN
MAX6018BEUR21+T	-40 $^{\circ}\text{C}$ to +85 $^{\circ}\text{C}$	3 SOT23-3	FZJO

Selector Guide

PART	OUTPUT VOLTAGE (V)	INITIAL ACCURACY (%)
MAX6018AEUR12	1.263	± 0.2
MAX6018BEUR12	1.263	± 0.4
MAX6018AEUR16	1.600	± 0.2
MAX6018BEUR16	1.600	± 0.4
MAX6018AEUR18	1.800	± 0.2
MAX6018BEUR18	1.800	± 0.4
MAX6018AEUR21	2.048	± 0.2
MAX6018BEUR21	2.048	± 0.4

MAX6018

Precision, Micropower, 1.8V Supply, Low-Dropout, SOT23 Voltage Reference

Absolute Maximum Ratings

(Voltages Referenced to GND)

V_{IN} -0.3V to +6V
 Output Short-Circuit Duration to GND or V_{IN} Continuous
 Continuous Power Dissipation ($T_A = +70^\circ\text{C}$)
 3-Pin SOT23 (derate 4.0mW/ $^\circ\text{C}$ above $+70^\circ\text{C}$) 320mW

Operating Temperature Range -40°C to $+85^\circ\text{C}$
 Junction Temperature $+150^\circ\text{C}$
 Storage Temperature Range -65°C to $+150^\circ\text{C}$
 Lead Temperature (soldering, 10s) $+300^\circ\text{C}$

Stresses beyond those listed under "Absolute Maximum Ratings" may cause permanent damage to the device. These are stress ratings only, and functional operation of the device at these or any other conditions beyond those indicated in the operational sections of the specifications is not implied. Exposure to absolute maximum rating conditions for extended periods may affect device reliability.

Electrical Characteristics (MAX6018_12–1.263V)

($V_{IN} = 1.8\text{V}$; $C_{OUT} = 47\text{nF}$, $I_{OUT} = 0$; $T_A = T_{MIN}$ to T_{MAX} , unless otherwise noted. Typical values are at $T_A = +25^\circ\text{C}$.) (Note 1)

PARAMETER	SYMBOL	CONDITIONS	MIN	TYP	MAX	UNITS
OUTPUT						
Output Voltage	V_{OUT}	MAX6018A_12 (0.2%)	1.2605	1.2630	1.2655	V
		MAX6018B_12 (0.4%)	1.2580	1.2630	1.2681	
Output Voltage Temperature Drift	TCV_{OUT}	(Note 2)		16	50	ppm/ $^\circ\text{C}$
Line Regulation	$\frac{\Delta V_{OUT}}{\Delta V_{IN}}$	$1.8\text{V} \leq V_{IN} \leq 5.5\text{V}$		50	400	$\mu\text{V}/\text{V}$
Load Regulation	$\frac{\Delta V_{OUT}}{\Delta I_{OUT}}$	$0 \leq I_{OUT} \leq 1\text{mA}$		90	700	$\mu\text{V}/\text{mA}$
		$-100\mu\text{A} \leq I_{OUT} \leq 0$		2	9	$\mu\text{V}/\mu\text{A}$
Short-Circuit Current	I_{SC}	Sourcing to GND		3		mA
		Sinking from V_{IN}		6		
Long-Term Stability	$\frac{\Delta V_{OUT}}{\text{Time}}$	1000hrs at $T_A = +25^\circ\text{C}$		100		ppm
Thermal Hysteresis		(Note 4)		130		ppm
DYNAMIC CHARACTERISTICS						
Noise Voltage	e_{OUT}	0.1Hz to 10Hz		45		μV_{p-p}
		10Hz to 10kHz		100		μV_{RMS}
Ripple Rejection		$V_{IN} = 1.8\text{V} \pm 100\text{mV}$ ($f = 120\text{Hz}$)		85		dB
Turn-On Settling Time	t_R	Settling to 0.1%; $C_{OUT} = 5\text{nF}$		200		μs
Capacitive-Load Stability Range	C_{OUT}	(Note 2)	47		1000	nF
INPUT						
Supply Voltage Range	V_{IN}	Guaranteed by Line Regulation Test	1.8		5.5	V
Quiescent Supply Current	I_{IN}	$T_A = +25^\circ\text{C}$		3	5	μA
		$T_A = T_{MIN}$ to T_{MAX}		3	6	
Change in Quiescent Supply Current vs. Input Voltage	$\frac{\Delta I_{IN}}{\Delta V_{IN}}$	$1.8\text{V} \leq V_{IN} \leq 5.5\text{V}$		0.1	0.5	$\mu\text{A}/\text{V}$

Electrical Characteristics (MAX6018_16–1.600V)(V_{IN} = 1.8V; C_{OUT} = 47nF, I_{OUT} = 0; T_A = T_{MIN} to T_{MAX}, unless otherwise noted. Typical values are at T_A = +25°C.) (Note 1)

PARAMETER	SYMBOL	CONDITIONS	MIN	TYP	MAX	UNITS	
OUTPUT							
Output Voltage	V _{OUT}	MAX6018A_16 (0.2%)	T _A = +25°C	1.5968	1.6000	1.6032	V
		MAX6018B_16 (0.4%)	T _A = +25°C	1.5936	1.6000	1.6064	
Output Voltage Temperature Drift	TCV _{OUT}	(Note 2)		16	50	ppm/°C	
Line Regulation	$\frac{\Delta V_{OUT}}{\Delta V_{IN}}$	1.8V ≤ V _{IN} ≤ 5.5V		40	250	μV/V	
Load Regulation	$\frac{\Delta V_{OUT}}{\Delta I_{OUT}}$	0 ≤ I _{OUT} ≤ 1mA		90	700	μV/mA	
		-750μA ≤ I _{OUT} ≤ 0		0.6	50	μV/μA	
Dropout Voltage (Note 3)	V _{IN} - V _{OUT}	I _{OUT} = 1mA		100	200	mV	
Short-Circuit Current	I _{SC}	Sourcing to GND		6		mA	
		Sinking from V _{IN}		2			
Long-Term Stability	$\frac{\Delta V_{OUT}}{\text{Time}}$	1000hrs at T _A = +25°C		100		ppm	
Thermal Hysteresis		(Note 4)		130		ppm	
DYNAMIC CHARACTERISTICS							
Noise Voltage	e _{OUT}	0.1Hz to 10Hz		40		μV _{p-p}	
		10Hz to 10kHz		150		μV _{RMS}	
Ripple Rejection		V _{IN} = 1.8V ±100mV (f = 120Hz)		85		dB	
Turn-On Settling Time	t _R	Settling to 0.1%; C _{OUT} = 5nF		200		μs	
Capacitive-Load Stability Range	C _{OUT}	(Note 2)	0.1		1000	nF	
INPUT							
Supply Voltage Range	V _{IN}	Guaranteed by Line Regulation Test	1.8		5.5	V	
Quiescent Supply Current	I _{IN}	T _A = +25°C		3	5	μA	
		T _A = T _{MIN} to T _{MAX}		3	6		
Change in Quiescent Supply Current vs. Input Voltage	$\Delta I_{IN}/\Delta V_{IN}$	1.8V ≤ V _{IN} ≤ 5.5V		0.1	0.5	μA/V	

Electrical Characteristics (MAX6018_18–1.800V)(V_{IN} = 2.0V; C_{OUT} = 47nF, I_{OUT} = 0; T_A = T_{MIN} to T_{MAX}, unless otherwise noted. Typical values are at T_A = +25°C.) (Note 1)

PARAMETER	SYMBOL	CONDITIONS	MIN	TYP	MAX	UNITS	
OUTPUT							
Output Voltage	V _{OUT}	MAX6018A_18 (0.2%)	T _A = +25°C	1.7964	1.8000	1.8036	V
		MAX6018B_18 (0.4%)	T _A = +25°C	1.7928	1.8000	1.8072	
Output Voltage Temperature Drift	TCV _{OUT}	(Note 2)		16	50	ppm/°C	
Line Regulation	$\frac{\Delta V_{OUT}}{\Delta V_{IN}}$	2.0V ≤ V _{IN} ≤ 5.5V		40	275	μV/V	
Load Regulation	$\frac{\Delta V_{OUT}}{\Delta I_{OUT}}$	0 ≤ I _{OUT} ≤ 1mA		90	800	μV/mA	
		-1mA ≤ I _{OUT} ≤ 0		0.4	50	μV/μA	
Dropout Voltage (Note 3)	V _{IN} - V _{OUT}	I _{OUT} = 1mA		100	200	mV	
Short-Circuit Current	I _{SC}	Sourcing to GND		7.5		mA	
		Sinking from V _{IN}		3			
Long-Term Stability	$\frac{\Delta V_{OUT}}{\text{Time}}$	1000hrs at T _A = +25°C		100		ppm	
Thermal Hysteresis		(Note 4)		130		ppm	
DYNAMIC CHARACTERISTICS							
Noise Voltage	e _{OUT}	0.1Hz to 10Hz		45		μV _{p-p}	
		10Hz to 10kHz		160		μV _{RMS}	
Ripple Rejection		V _{IN} = 2.0V ±100mV (f = 120Hz)		85		dB	
Turn-On Settling Time	t _R	Settling to 0.1%; C _{OUT} = 5nF		200		μs	
Capacitive-Load Stability Range	C _{OUT}	(Note 2)	0.1		1000	nF	
INPUT							
Supply Voltage Range	V _{IN}	Guaranteed by Line Regulation Test	2.0		5.5	V	
Quiescent Supply Current	I _{IN}	T _A = +25°C		3	5	μA	
		T _A = T _{MIN} to T _{MAX}		3	6		
Change in Quiescent Supply Current vs. Input Voltage	$\Delta I_{IN}/\Delta V_{IN}$	2V ≤ V _{IN} ≤ 5.5V		0.1	0.5	μA/V	

Electrical Characteristics (MAX6018_21–2.048V)

(V_{IN} = 2.25V; C_{OUT} = 47nF, I_{OUT} = 0; T_A = T_{MIN} to T_{MAX}, unless otherwise noted. Typical values are at T_A = +25°C.) (Note 1)

PARAMETER	SYMBOL	CONDITIONS	MIN	TYP	MAX	UNITS	
OUTPUT							
Output Voltage	V _{OUT}	MAX6018A_21 (0.2%)	T _A = +25°C	2.0439	2.0480	2.0521	V
		MAX6018B_21 (0.4%)	T _A = +25°C	2.0398	2.0480	2.0562	
Output Voltage Temperature Drift	TCV _{OUT}	(Note 2)		16	50	ppm/°C	
Line Regulation	$\frac{\Delta V_{OUT}}{\Delta V_{IN}}$	2.25V ≤ V _{IN} ≤ 5.5V		45	330	μV/V	
Load Regulation	$\frac{\Delta V_{OUT}}{\Delta I_{OUT}}$	0 ≤ I _{OUT} ≤ 1mA		90	1000	μV/mA	
		-1mA ≤ I _{OUT} ≤ 0		0.3	50	μV/μA	
Dropout Voltage (Note 3)	V _{IN} - V _{OUT}	I _{OUT} = 1mA		100	200	mV	
Short-Circuit Current	I _{SC}	Sourcing to GND		10		mA	
		Sinking from V _{IN}		4			
Long-Term Stability	$\frac{\Delta V_{OUT}}{\text{Time}}$	1000hrs at T _A = +25°C		100		ppm	
Thermal Hysteresis		(Note 4)		130		ppm	
DYNAMIC CHARACTERISTICS							
Noise Voltage	e _{OUT}	0.1Hz to 10Hz		50		μV _{p-p}	
		10Hz to 10kHz		175		μV _{RMS}	
Ripple Rejection		V _{IN} = 2.25V ±100mV (f = 120Hz)		85		dB	
Turn-On Settling Time	t _R	Settling to 0.1%; C _{OUT} = 5nF		200		μs	
Capacitive-Load Stability Range	C _{OUT}	(Note 2)	0.1		1000	nF	
INPUT							
Supply Voltage Range	V _{IN}	Guaranteed by Line Regulation Test	2.25		5.5	V	
Quiescent Supply Current	I _{IN}	T _A = +25°C		3	5	μA	
		T _A = T _{MIN} to T _{MAX}		3	6		
Change in Quiescent Supply Current vs. Input Voltage	$\Delta I_{IN}/\Delta V_{IN}$	2.25V ≤ V _{IN} ≤ 5.5V		0.1	0.5	μA/V	

Note 1: Devices are 100% production tested at T_A = +25°C and are guaranteed by design from T_A = T_{MIN} to T_{MAX}.**Note 2:** Not production tested. Guaranteed by design.**Note 3:** Dropout voltage is the minimum input voltage at which V_{OUT} changes ≤ 0.2% from V_{OUT} at rated V_{IN} and is guaranteed by Load Regulation Test.**Note 4:** Thermal hysteresis is defined as the change in T_A = +25°C output voltage before and after temperature cycling of the device (from T_A = T_{MIN} to T_{MAX}). Initial measurement at T_A = +25°C is followed by temperature cycling the device to T_A = +85°C then to T_A = -40°C and another measurement at T_A = +25°C is compared to the original measurement at T_A = +25°C.

Typical Operating Characteristics

($T_A = +25^\circ\text{C}$, unless otherwise noted.)

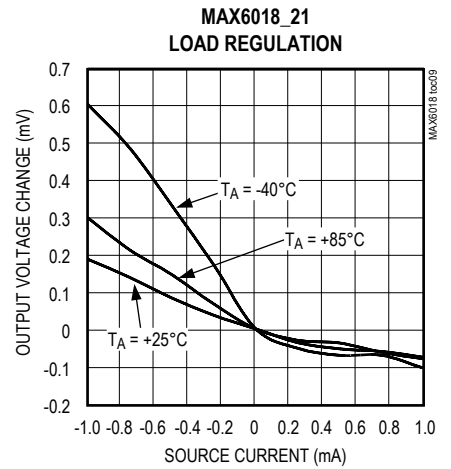
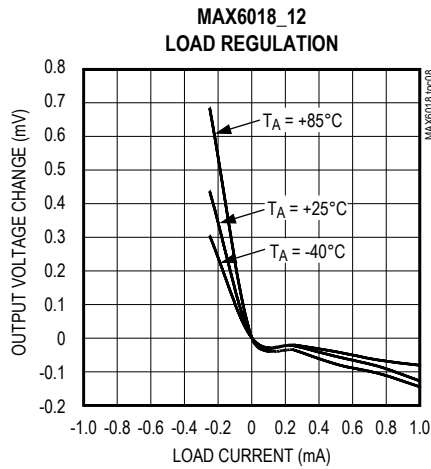
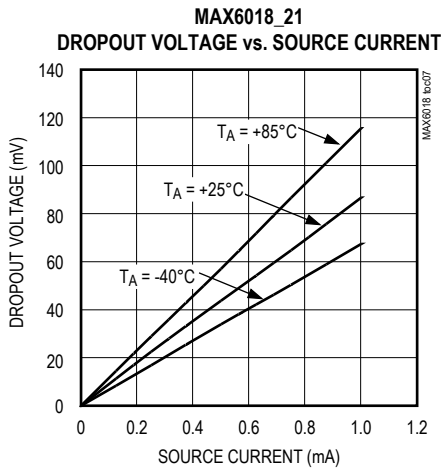
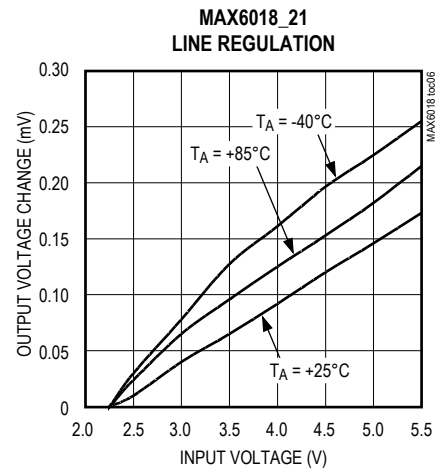
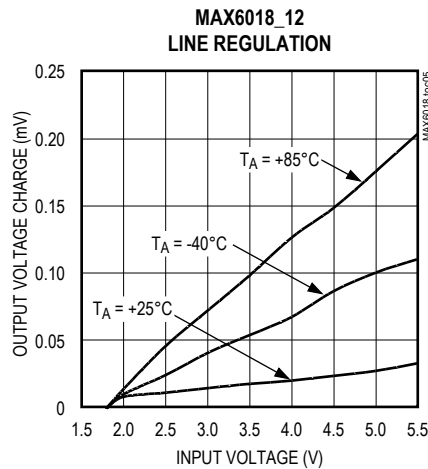
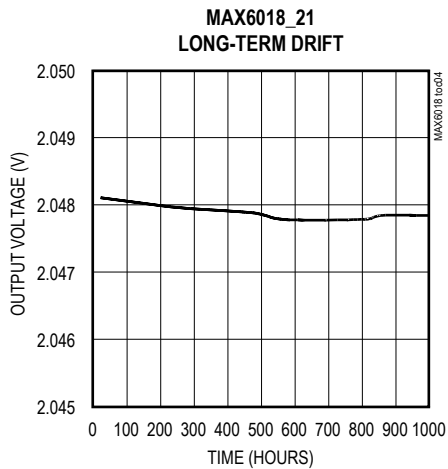
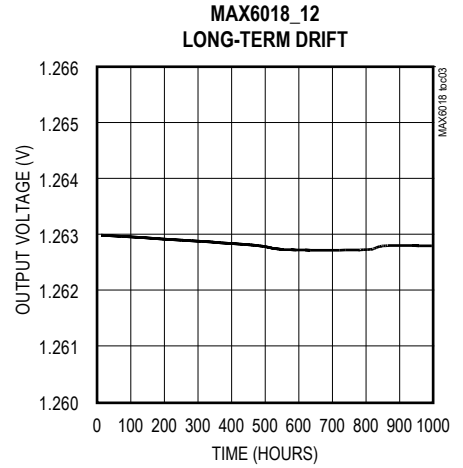
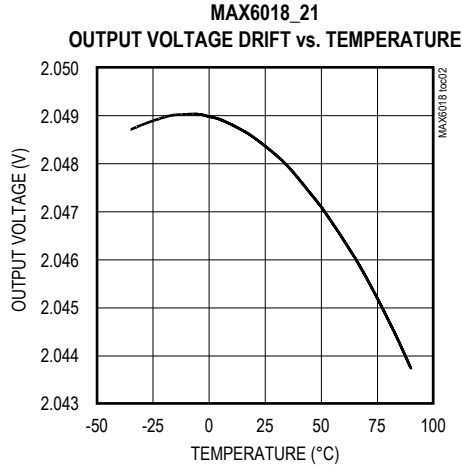
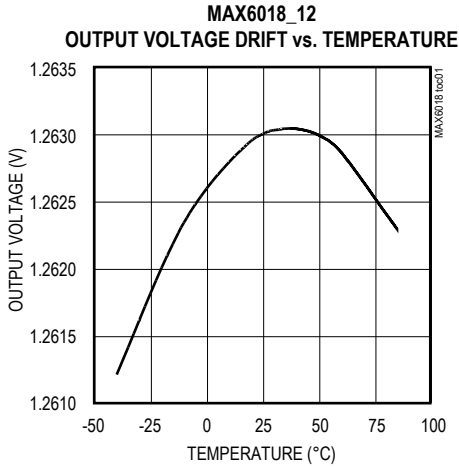

Typical Operating Characteristics (continued)

(TA = +25°C, unless otherwise noted.)

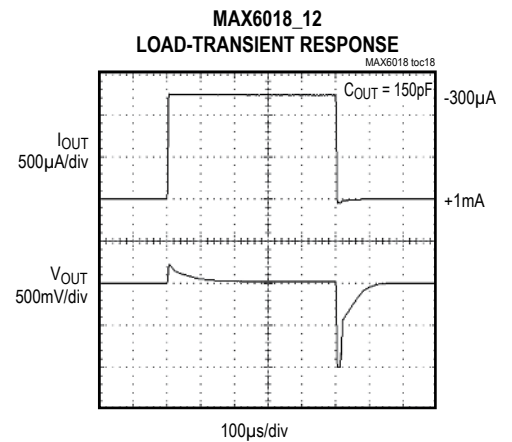
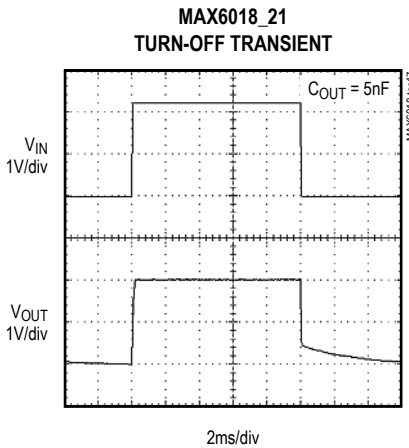
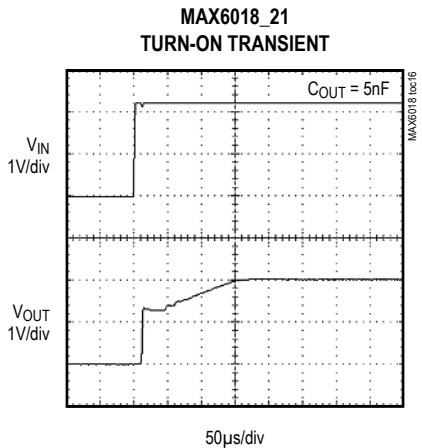
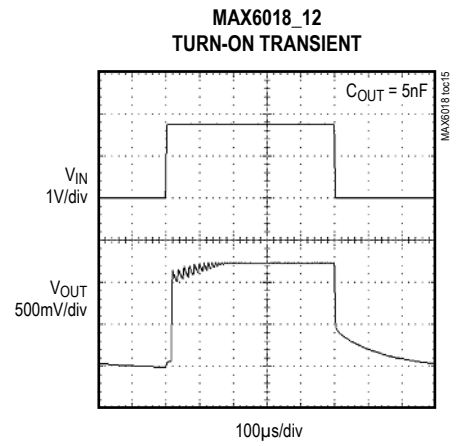
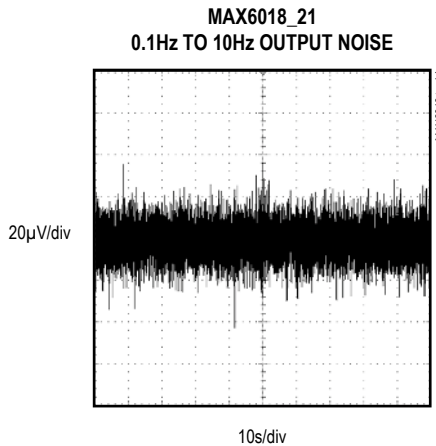
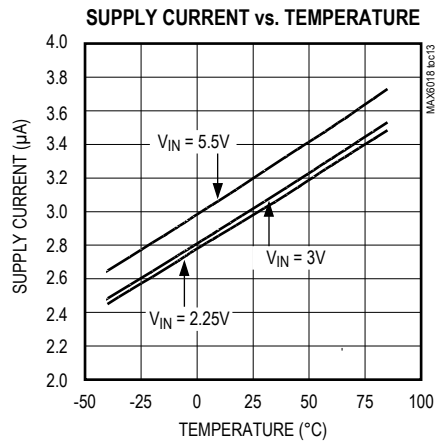
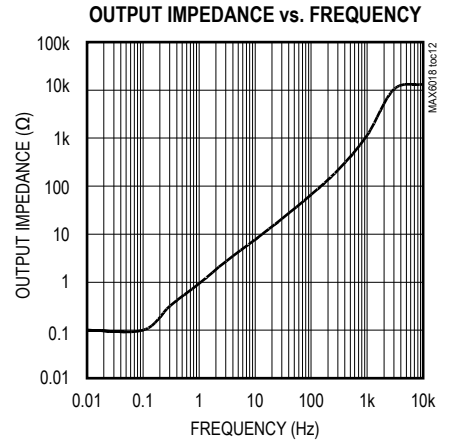
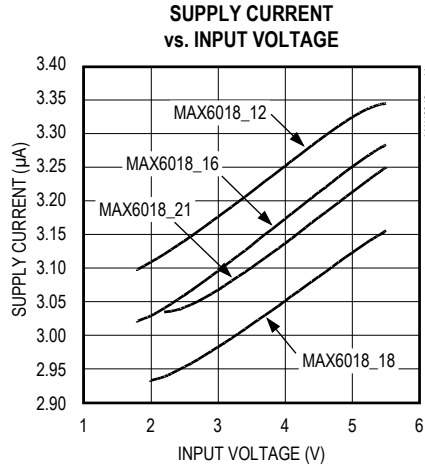
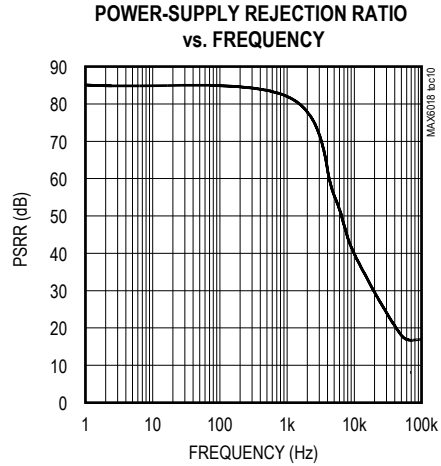

Typical Operating Characteristics (continued)

(TA = +25°C, unless otherwise noted.)

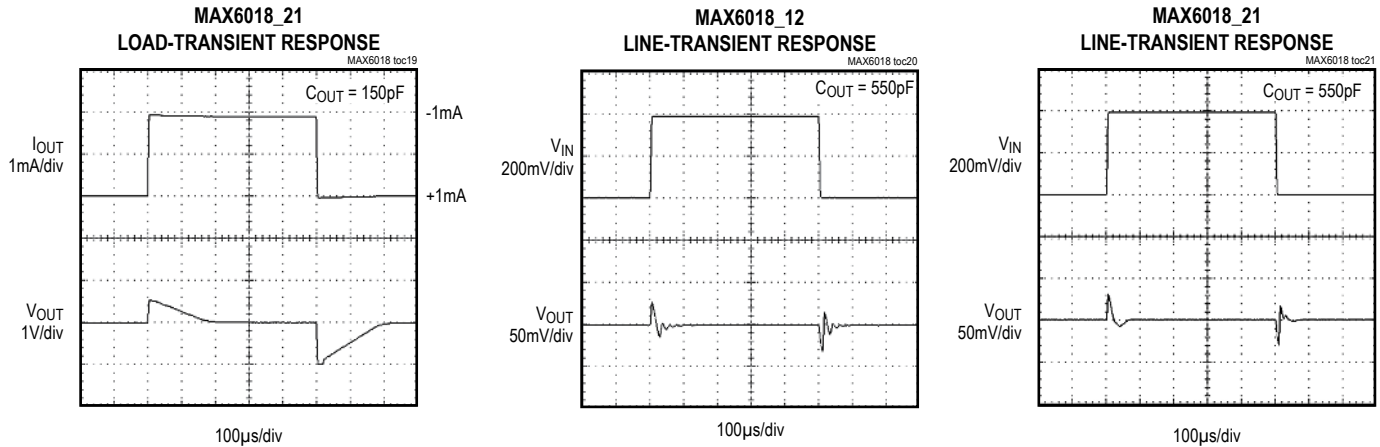

Detailed Description

The MAX6018 is a precision, low-voltage, low-dropout, micropower, bandgap voltage reference in a SOT23 package. This three-terminal reference operates with an input voltage from (VOUT + 200mV) to 5.5V, and is available with output voltage options of 1.2V, 1.6V, 1.8V, and 2.048V. These devices can source up to 1mA with <200mV of dropout voltage, making them attractive for use in low-voltage applications.

Applications Information

Output/Load Capacitance

These devices require a minimum of 100pF load to maintain output stability.

They remain stable for capacitive loads as high as 1µF. In applications where the load or the supply can experience step changes, a larger output capacitor reduces the amount of overshoot (or undershoot) and assists the circuit's transient response. Otherwise, applications may not need more than 100pF.

Supply Current

The 5µA maximum supply current varies only 0.1µA/V with the supply voltage.

When the supply voltage is below the minimum-specified input voltage (as during turn-on), the devices can draw up to 20µA beyond the nominal supply current. The input voltage source must be capable of providing this current to ensure reliable turn-on.

Pin Description

PIN	NAME	FUNCTION
1	IN	Supply Voltage Input. Bypass with a 0.1µF capacitor to ground.
2	OUT	Reference Voltage Output. Bypass with at least 100pF to ground. (See <i>Output/Load Capacitance</i> section).
3	GND	Ground

Turn-On Time

These devices typically turn on and settle to within 0.1% of their final value in 200µs. The turn-on time can increase up to 1ms with the device operating at the minimum dropout voltage and the maximum load.

MAX6018

Precision, Micropower, 1.8V Supply,
Low-Dropout, SOT23 Voltage Reference

Package Information

For the latest package outline information and land patterns (footprints), go to www.maximintegrated.com/packages. Note that a "+", "#", or "-" in the package code indicates RoHS status only. Package drawings may show a different suffix character, but the drawing pertains to the package regardless of RoHS status.

PACKAGE TYPE	PACKAGE CODE	OUTLINE NO.	LAND PATTERN NO.
3 SOT23	U3+1	21-0051	90-0179

Chip Information

TRANSISTOR COUNT: 87

PROCESS: BiCMOS

MAX6018

Precision, Micropower, 1.8V Supply,
Low-Dropout, SOT23 Voltage Reference

Revision History

REVISION NUMBER	REVISION DATE	DESCRIPTION	PAGES CHANGED
3	10/15	Added lead-free options	1

For pricing, delivery, and ordering information, please contact Maxim Direct at 1-888-629-4642, or visit Maxim Integrated's website at www.maximintegrated.com.

Maxim Integrated cannot assume responsibility for use of any circuitry other than circuitry entirely embodied in a Maxim Integrated product. No circuit patent licenses are implied. Maxim Integrated reserves the right to change the circuitry and specifications without notice at any time. The parametric values (min and max limits) shown in the Electrical Characteristics table are guaranteed. Other parametric values quoted in this data sheet are provided for guidance.